

# Electromagnetic Background Tests for the ILC Interaction Point Feedback System

---

**Philip Burrows**  
*John Adams Institute*  
*Oxford University*

G. Christian, **C. Clarke**, B. Constance, H. Dabiri Khah,  
**T. Hartin**, C. Perry, **C. Swinson**  
*John Adams Institute, Oxford University*

A. Kalinin, *Daresbury Laboratory*

R. Arnold, S. Molloy, S. Smith, G.R. White, M. Woods, *SLAC*

# Outline

---

- **Introduction**
- **ILC interaction point intra-train feedback system**
- **Beam-beam interaction and EM backgrounds**
- **T488 experiment at SLAC Endstation A**
- **Conclusions**

# International Linear Collider

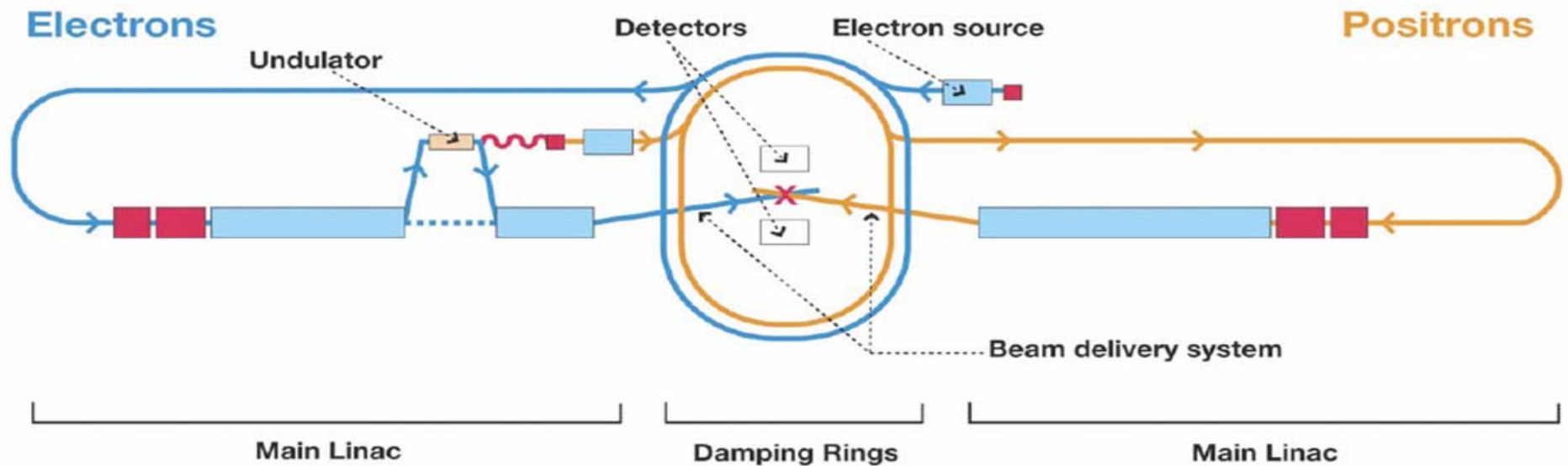

# International Linear Collider

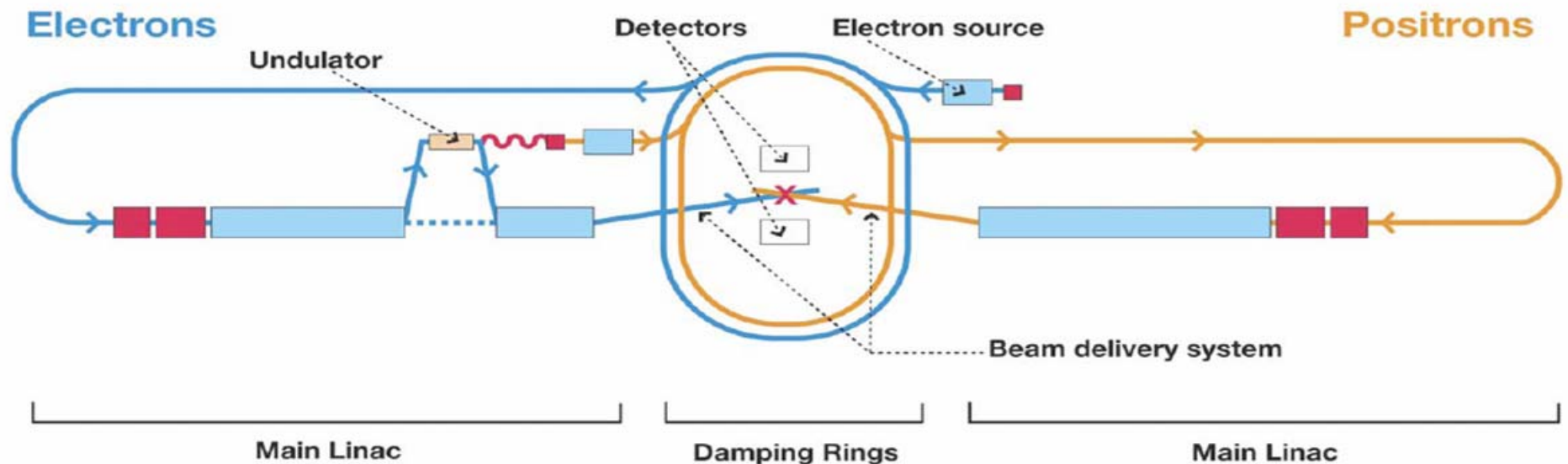

- Machine repetition rate 5 Hz
- Trains of c. 3000 bunches, spacing c. 300ns
- Beam size at IP c. 5nm (y) X 500nm (x)

# International Linear Collider

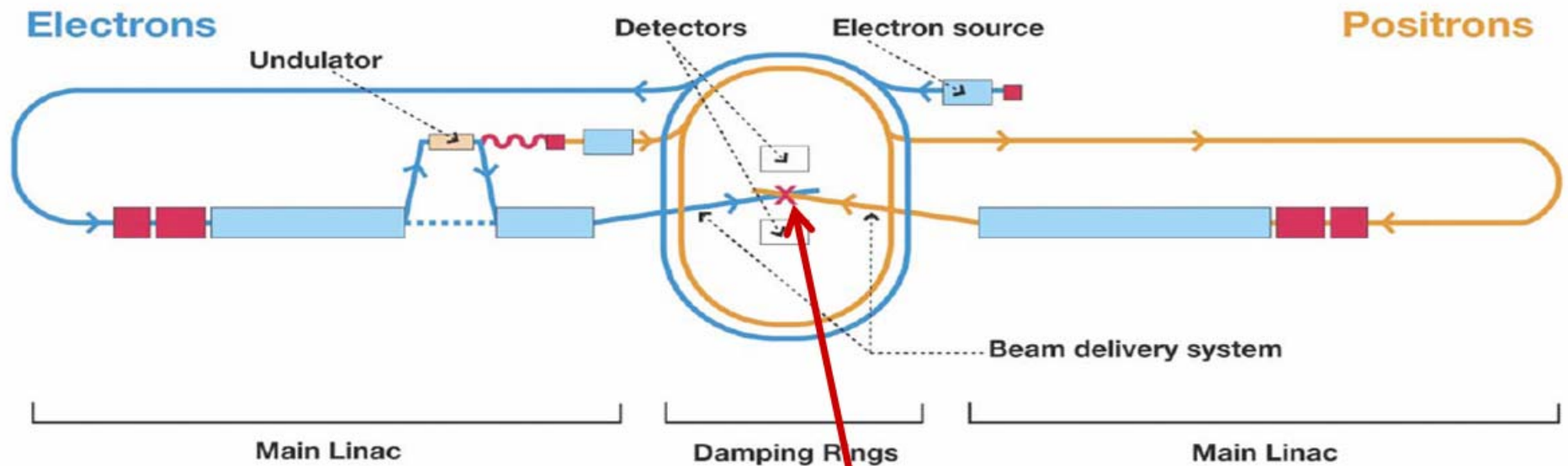

**Intra-train collision feedback at interaction point (IP)**

# Intra-train feedback system - concept

Last line of defence  
against relative  
beam misalignment

Measure vertical  
position of outgoing  
beam and hence  
beam-beam kick  
angle

Use fast amplifier and  
kicker to correct  
vertical position of  
incoming beam

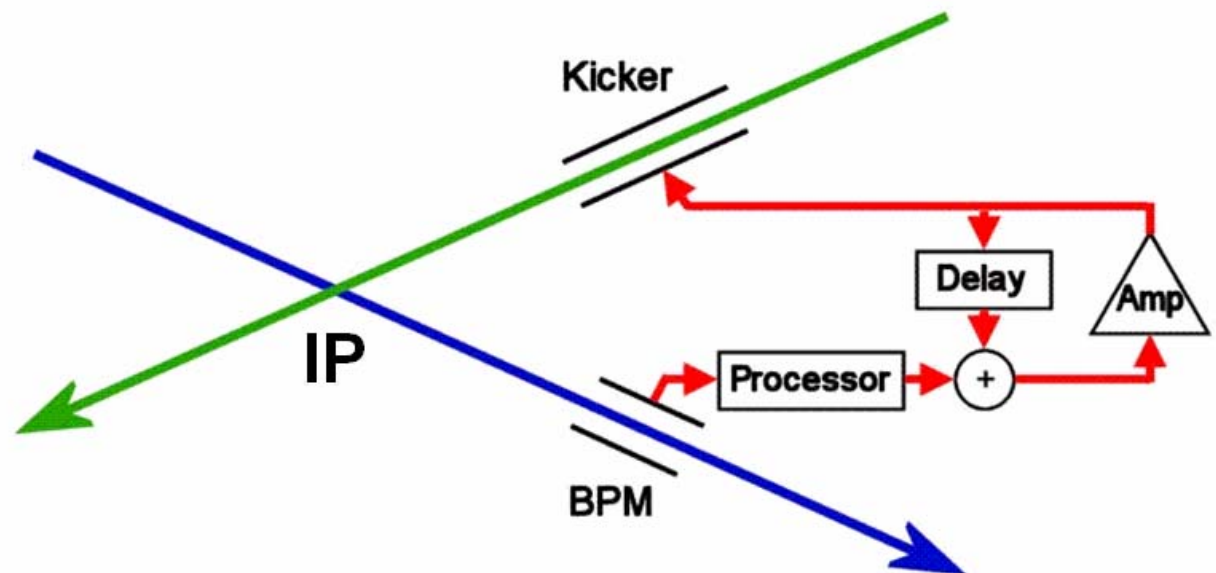

**FONT:**  
**Feedback On**  
**Nanosecond Timescales**

# FONT4 prototype at KEK/ATF

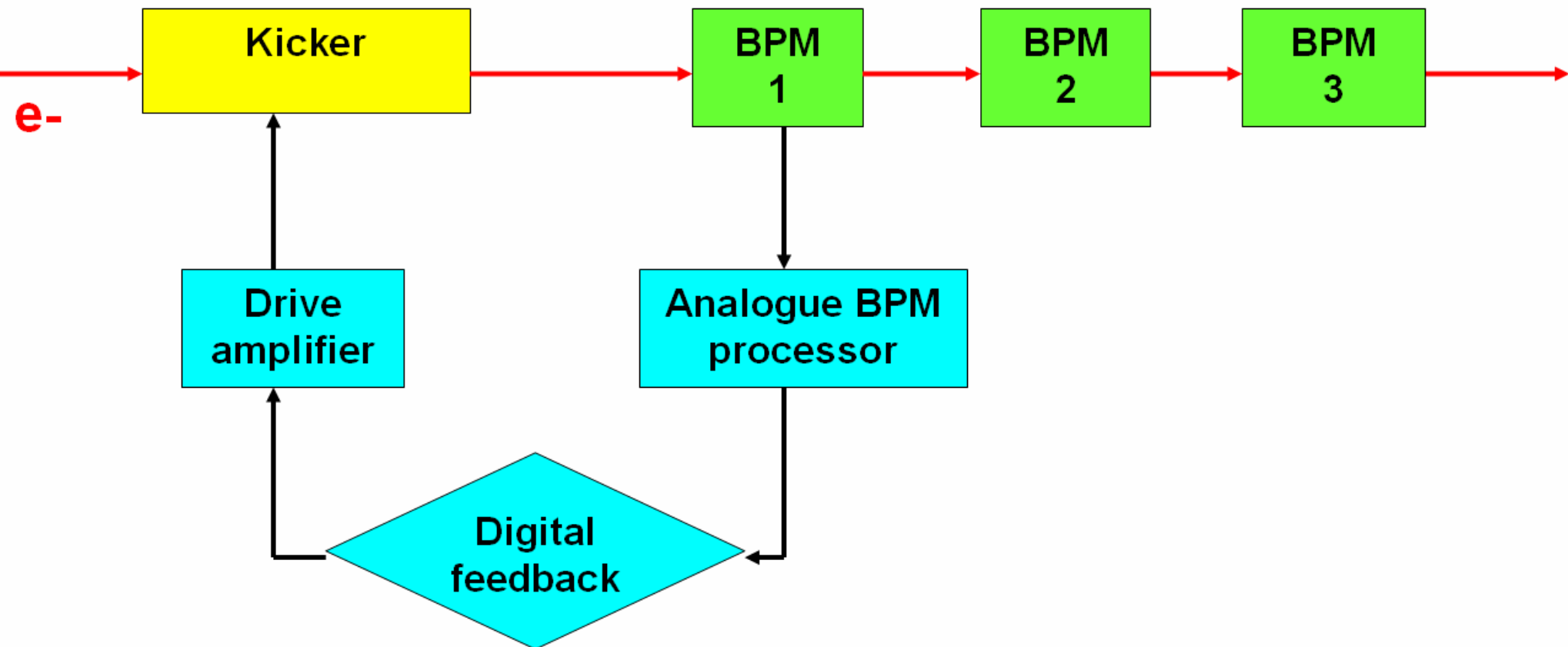

# FONT4 prototype at KEK/ATF

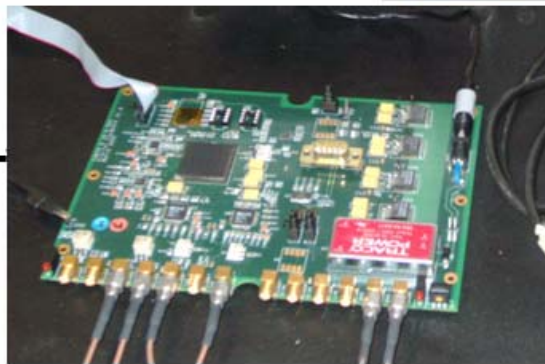

**Latency ~ 140ns**

**Poster + paper:  
MOPAN108**



# ILC interaction region (schematic)

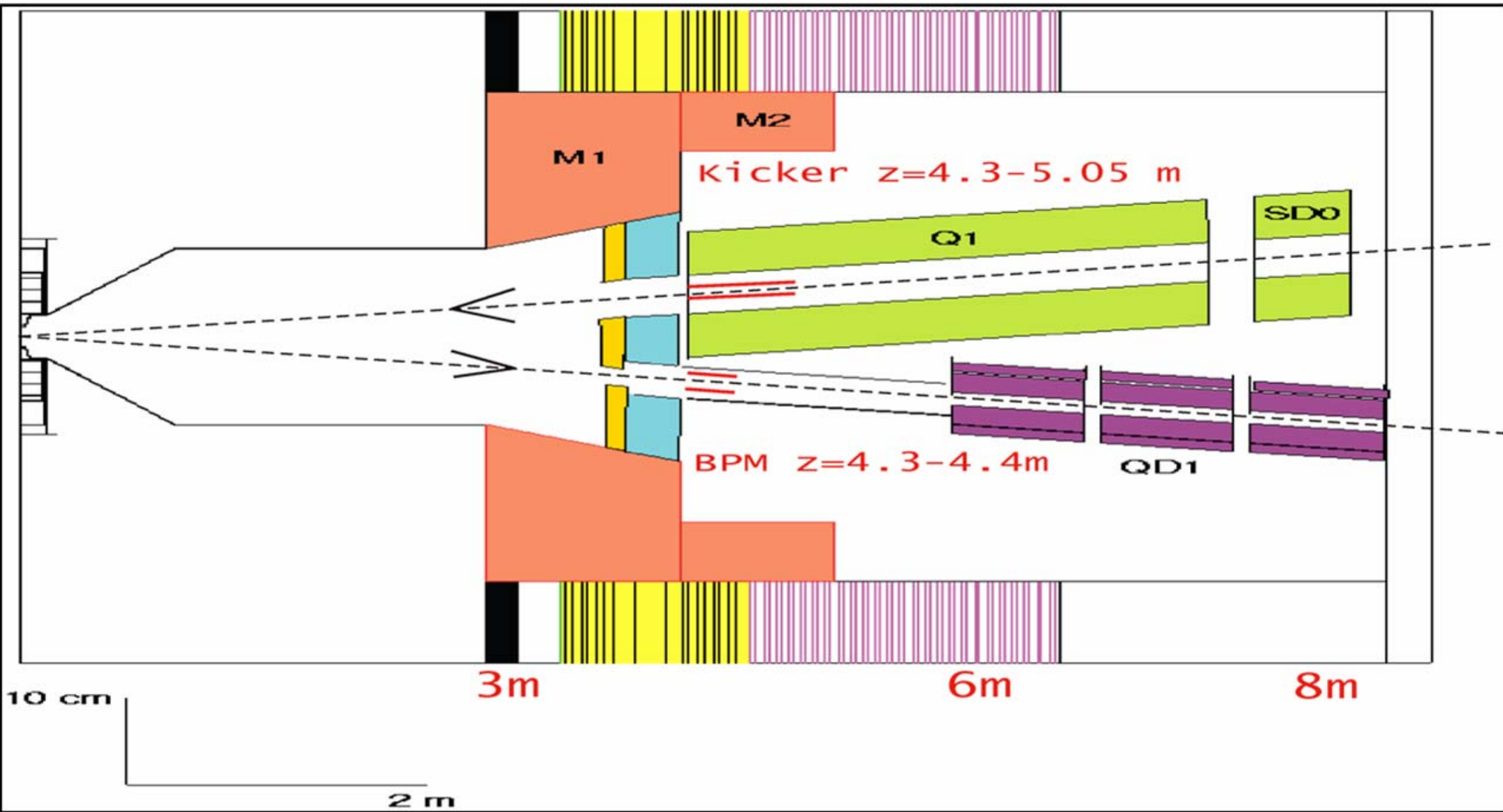

# Nominal IP feedback BPM location

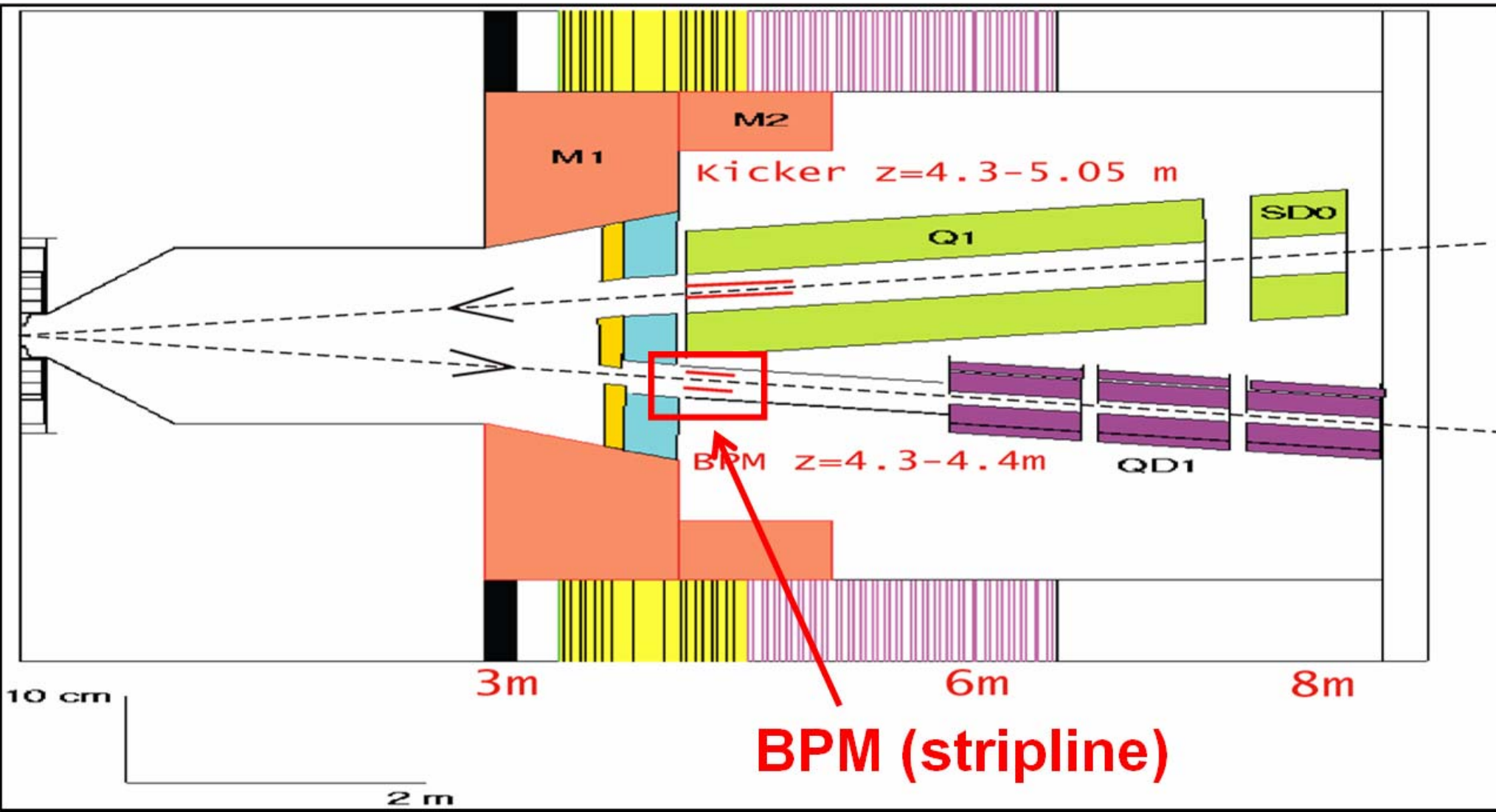

# Pair-induced EM backgrounds

Low-Z mask + beamline calorimeter

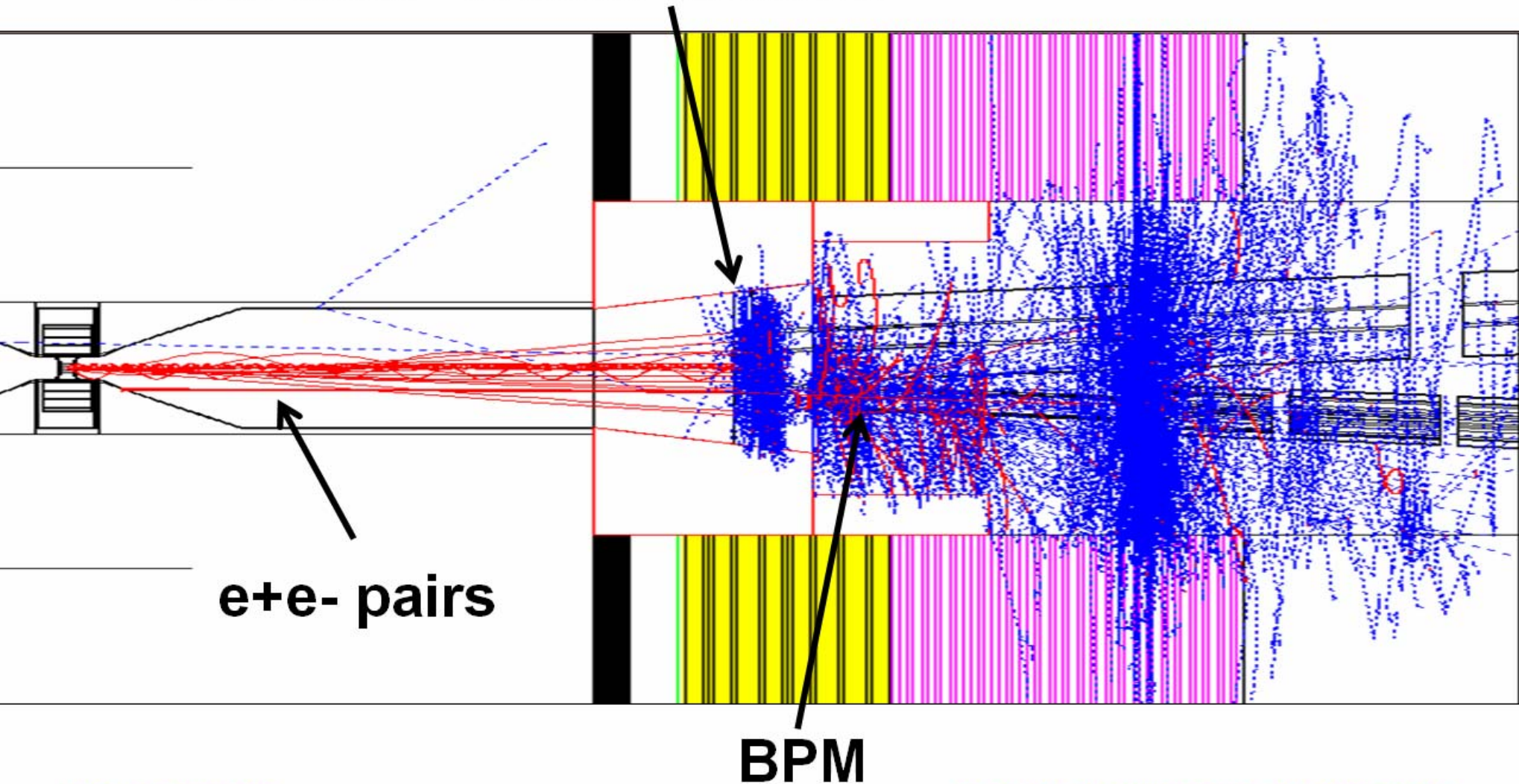

$e^+e^-$  pairs

BPM

# Backgrounds due to $e^+e^-$ pairs

Beam Parameters Scheme	Number of Pair Particles	Average Energy (GeV)	BPM hits
Scheme 1	195652	10.8	5141
Scheme 2	164370	10.6289	4497
Scheme 3	121966	10.8947	3057
Scheme 4	49720	12.3421	1074
Scheme 5	124273	9.58301	2321
Scheme 6	272218	10.6636	9686
Scheme 7	320352	10.9809	12314
Scheme 8	193166	11.2826	5127
Scheme 9	237749	11.5317	8758
Scheme 10	192976	11.3083	6399
Scheme 11	85218	12.8034	2623
Scheme 12	247683	10.1212	9287
Scheme 13	500457	13.8549	25016
Scheme 14	678811	15.5845	80443

# Backgrounds due to $e^+e^-$ pairs

Beam Parameters Scheme	Number of Pair Particles	Average Energy (GeV)	BPM hits
Scheme 1	195652	10.8	5141
Scheme 2	164370	10.6289	4497
Scheme 3	121966	10.8947	3057
Scheme 4	49720	12.3421	1074
Scheme 5	124273	9.58301	2321
Scheme 6	272218	10.6636	9686
Scheme 7	320352	10.9809	12314
Scheme 8	193166	11.2826	5127
Scheme 9	237749	11.5317	8758
Scheme 10	192976	11.3083	6399
Scheme 11	85218	12.8034	2623
Scheme 12	247683	10.1212	9287
Scheme 13	500457	13.8549	25016
Scheme 14	678811	15.5845	80443

Parameter space for 500 GeV ILC

Parameter space for 1 TeV ILC

# Backgrounds due to e<sup>+</sup>e<sup>-</sup> pairs

Beam Parameters Scheme	Number of Pair Particles	Average Energy (GeV)	BPM hits
Scheme 1	195652	10.8	5141
Scheme 2	164370	10.6289	4497
Scheme 3	121966	10.8947	3057
Scheme 4	49720	12.3421	1074
Scheme 5	124273	9.58301	2321
Scheme 6	272218	10.6636	9686
Scheme 7	320352	10.9809	12314
Scheme 8	193166	11.2826	5127
Scheme 9	237749	11.5317	8758
Scheme 10	192976	11.3083	6399
Scheme 11	85218	12.8034	2623
Scheme 12	247683	10.1212	9287
Scheme 13	500457	13.8549	25016
Scheme 14	678811	15.5845	80443

Primaries  
per bunch  
crossing:  
50 – 700k

# Backgrounds due to e+e- pairs

Beam Parameters Scheme	Number of Pair Particles	Average Energy (GeV)	BPM hits
Scheme 1	195652	10.8	5141
Scheme 2	164370	10.5189	4497
Scheme 3	121966	10.8947	3057
Scheme 4	49720	12.3421	1074
Scheme 5	124273	11.5361	2321
Scheme 6	272218	11.6636	9686
Scheme 7	320352	10.9809	12314
Scheme 8	193166	11.2826	5127
Scheme 9	237749	11.5317	8758
Scheme 10	192976	11.3083	6399
Scheme 11	85218	12.8034	2623
Scheme 12	247683	10.1212	9287
Scheme 13	500457	13.8549	25016
Scheme 14	678811	15.5845	80443

**BPM hits  
per bunch  
crossing:  
1 - 80k**

# Pair-induced EM backgrounds

Low-Z mask + beamline calorimeter

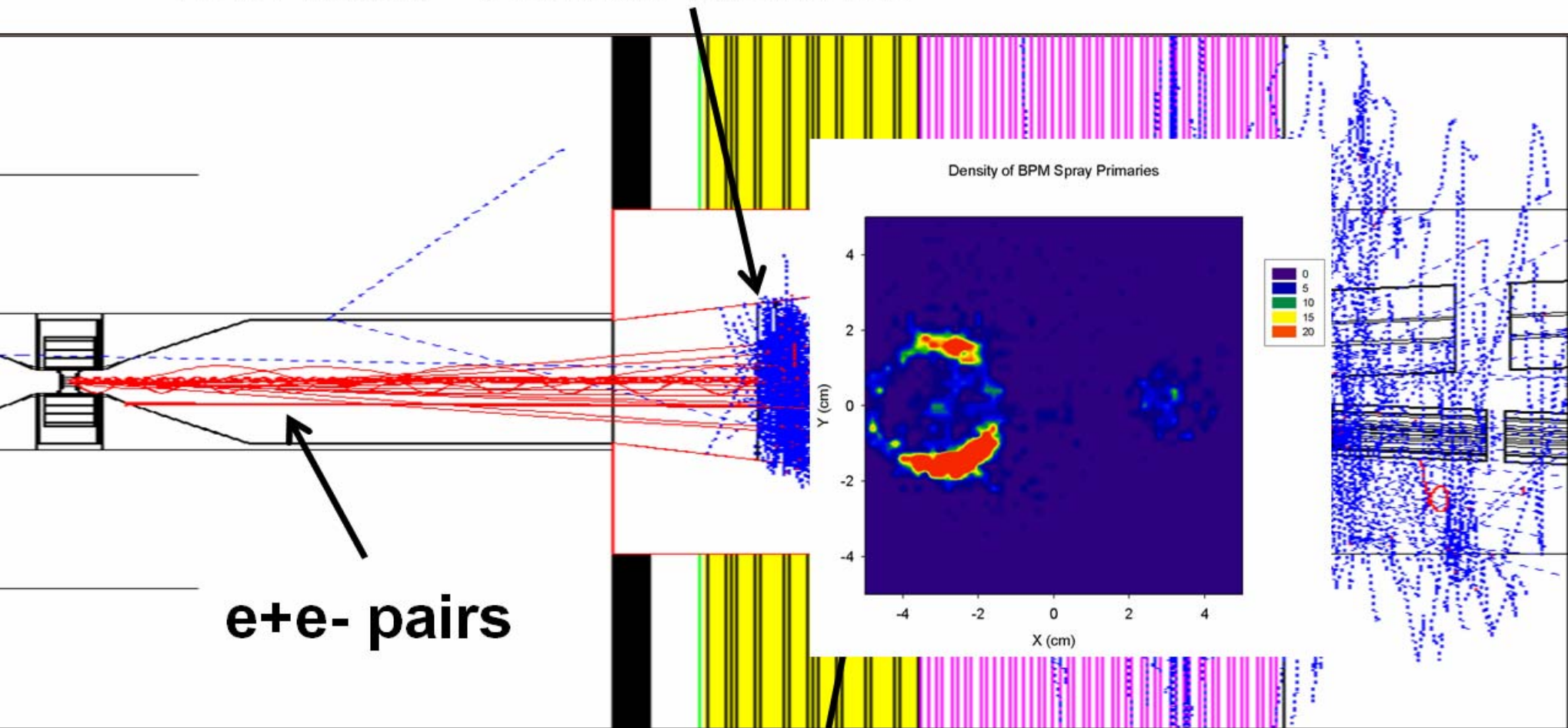

$e^+e^-$  pairs

BPM



# FONT Test Module for ESA

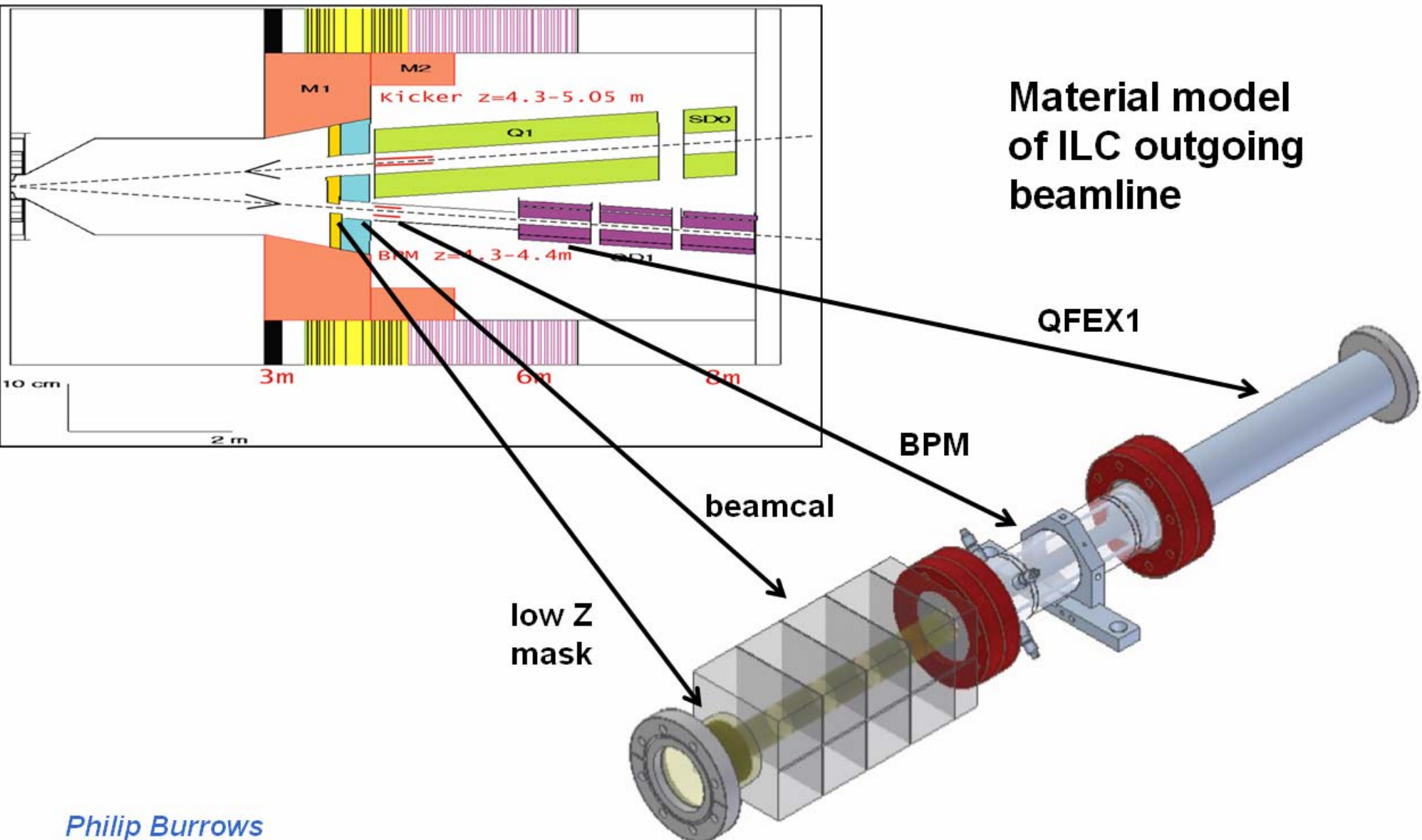

# FONT Test Module (T-488)

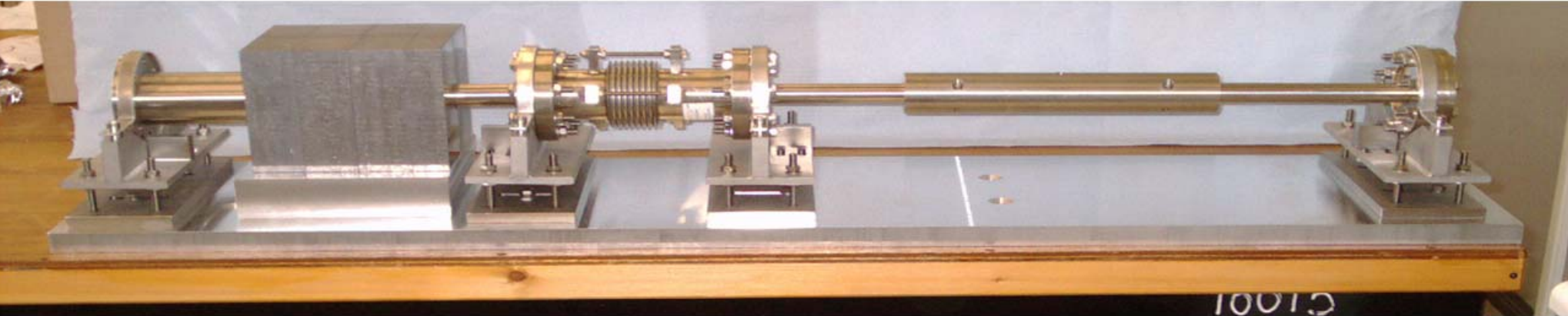

Installation  
at ESA

Beam →



# Overview of T-488 Experiment

- **Used 28.5 GeV SLAC beam to simulate ILC EM background environment:**
- **Mode 1:**
  - Large beam ~ 1mm diameter,  $10^{**6} < Q < 10^{**8}$**
  - Beam steered onto front of FONT module**
- **Mode 2:**
  - Beam passed through upstream thin radiator**
  - Main beam + halo that strikes module**

# Overview of T-488 Experiment

---

- **Used 28.5 GeV SLAC beam to simulate ILC EM background environment:**
  - **Mode 1:**
    - Lose primary beam signal in BPM**
    - Vary noise signal at BPM by varying Q**
  - **Mode 2:**
    - Still get primary beam signal in BPM**
    - Tune noise signal at BPM by varying X0**
- Studied impact on stripline BPM signals**

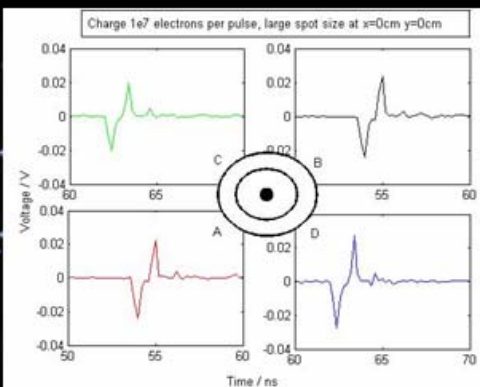

## Mode 1: beam scan across module: stripline BPM signals

---

**$10^{**7}$  beam**

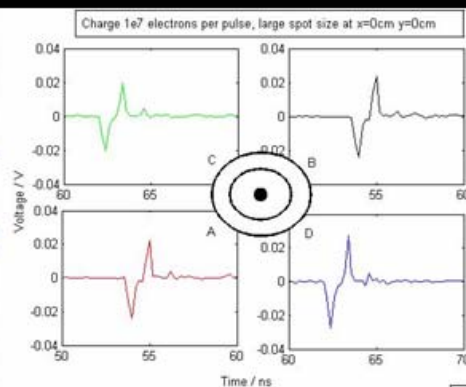

# Mode 1: beam scan across module: stripline BPM signals

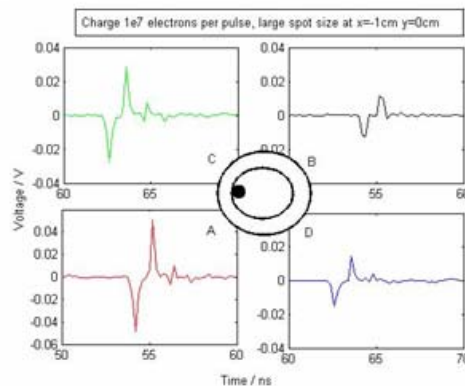

10\*\*7 beam

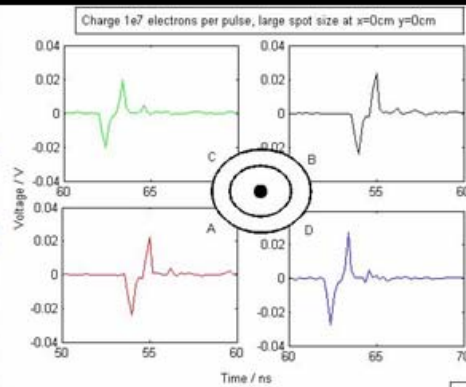

# Mode 1: beam scan across module: stripline BPM signals

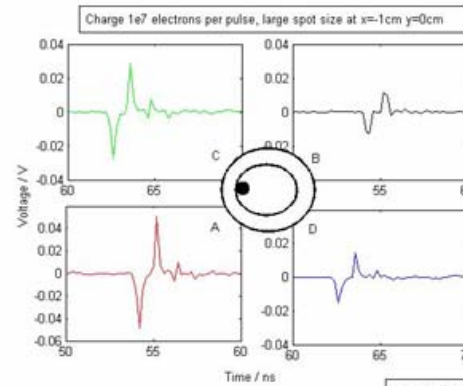

**$10^{**7}$  beam**

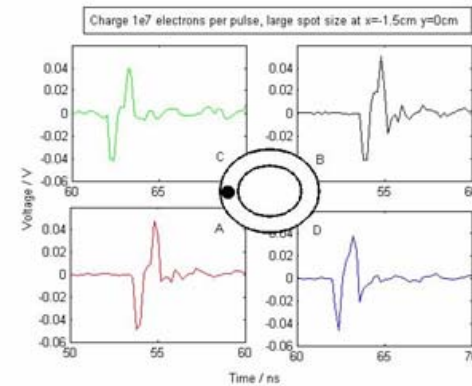



# Mode 1: beam scan across module: stripline BPM signals

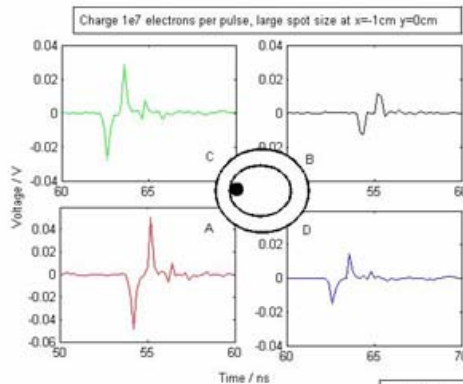
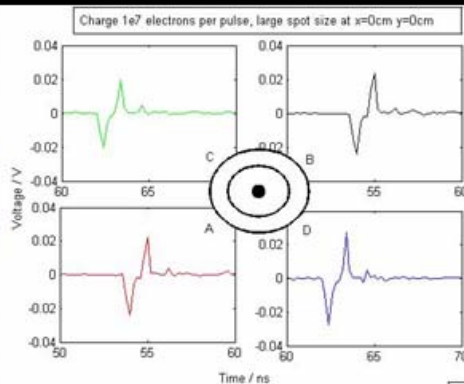

**10\*\*7 beam**

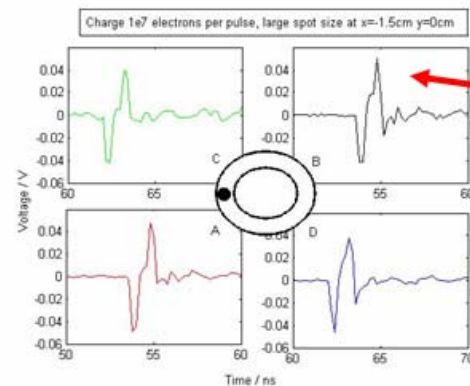

**Noticeable degradation of signals**

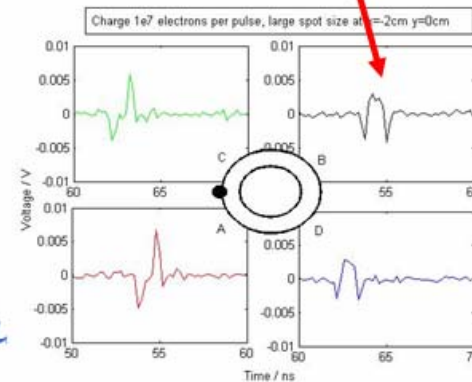



# Modelling of noise on BPM strips

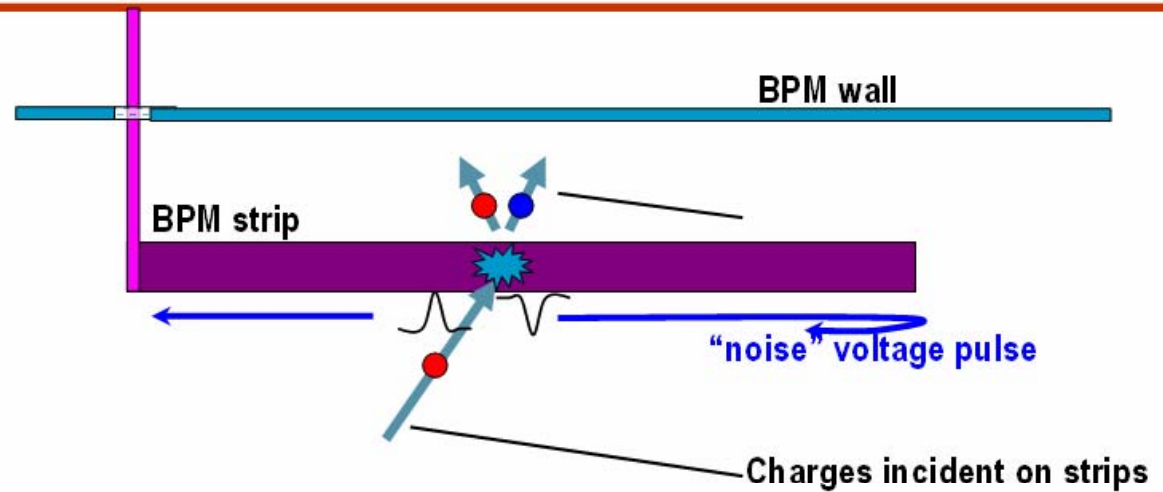

# Modelling of noise on BPM strips

## Poster: THPMN079

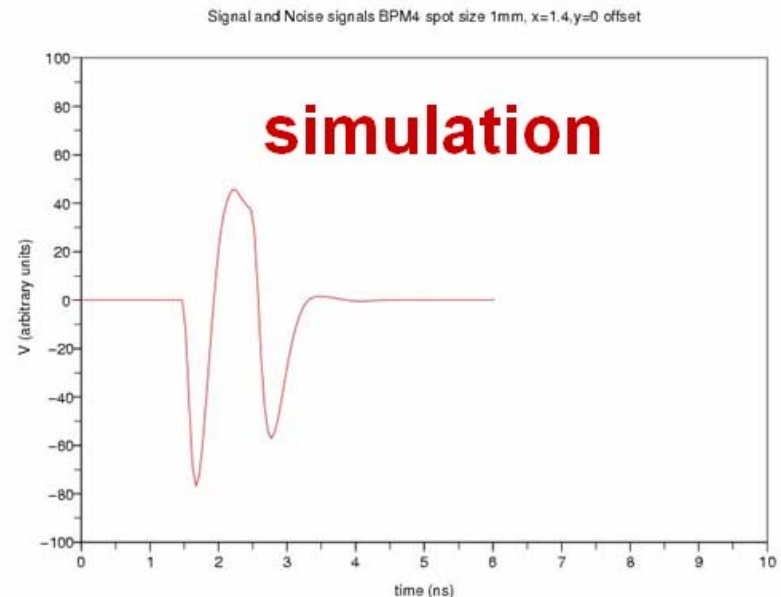
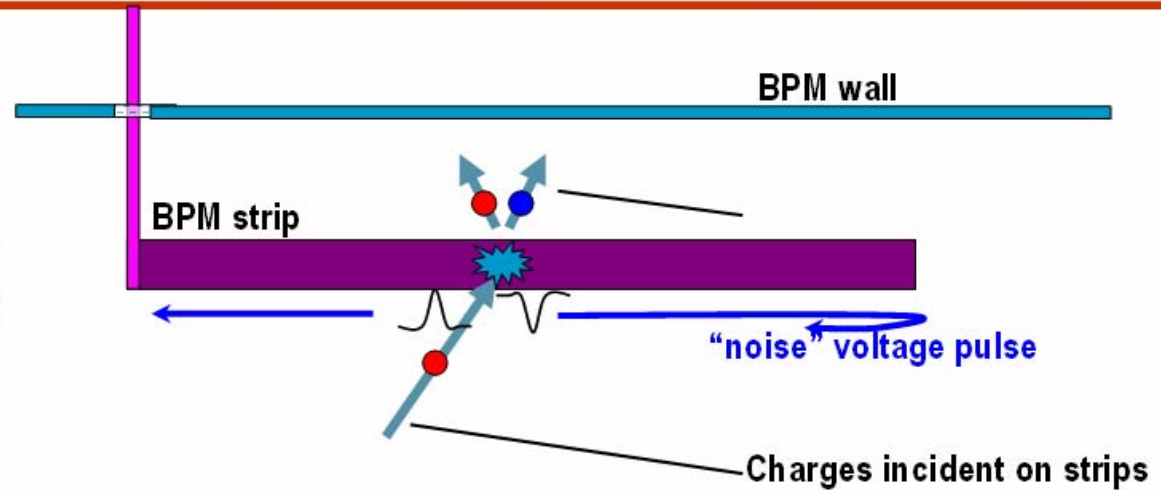
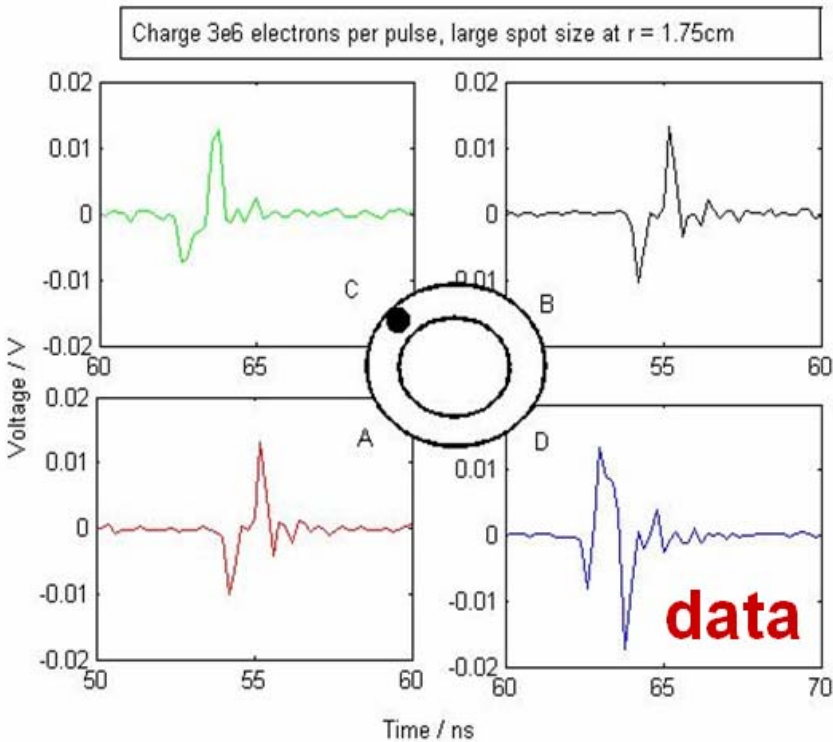

# Mode 2: primary beam + halo

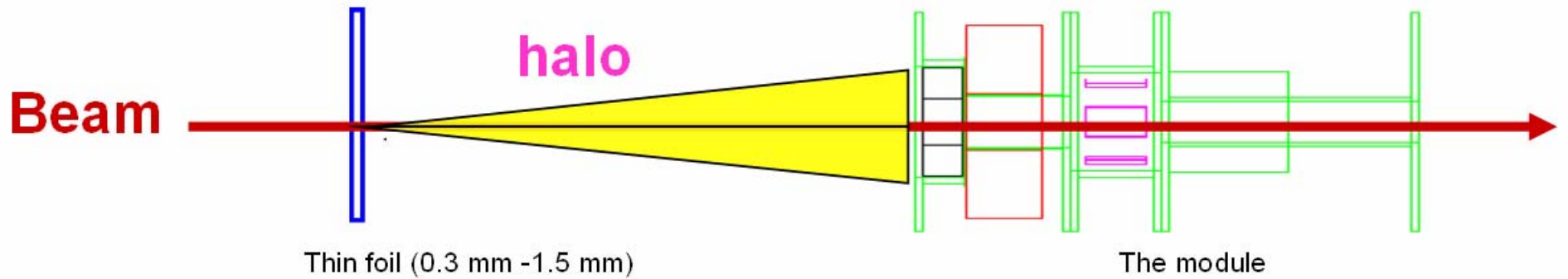

## Scaling from ESA to ILC:

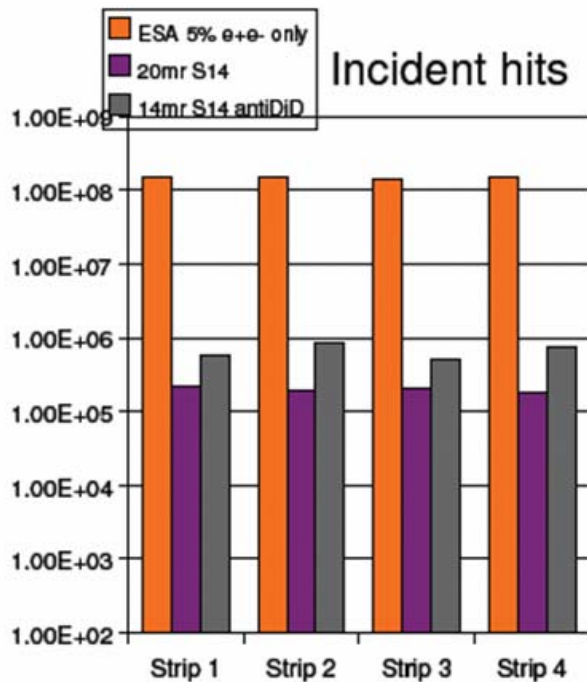

← ESA →

← ILC →

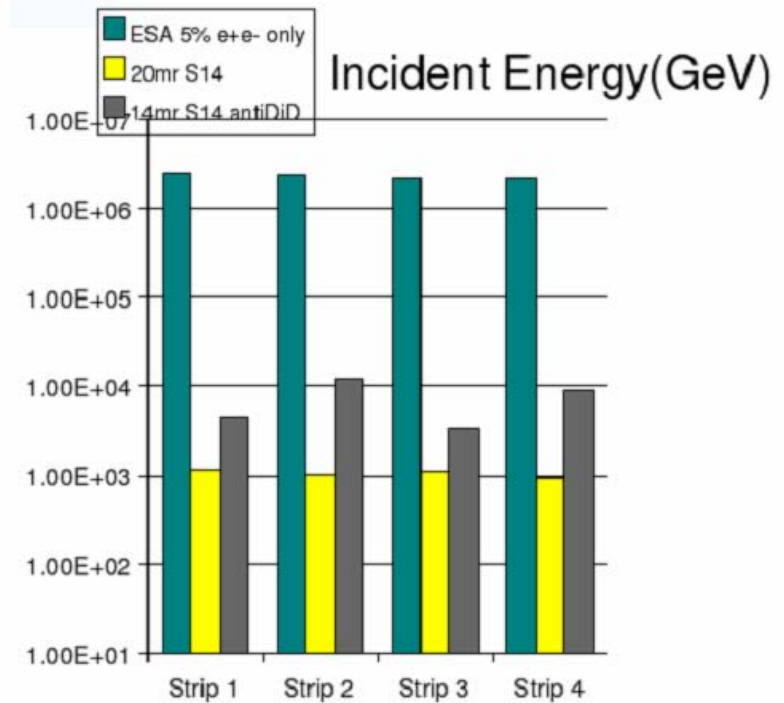

# Mode 2: results: worst case: 5% foil

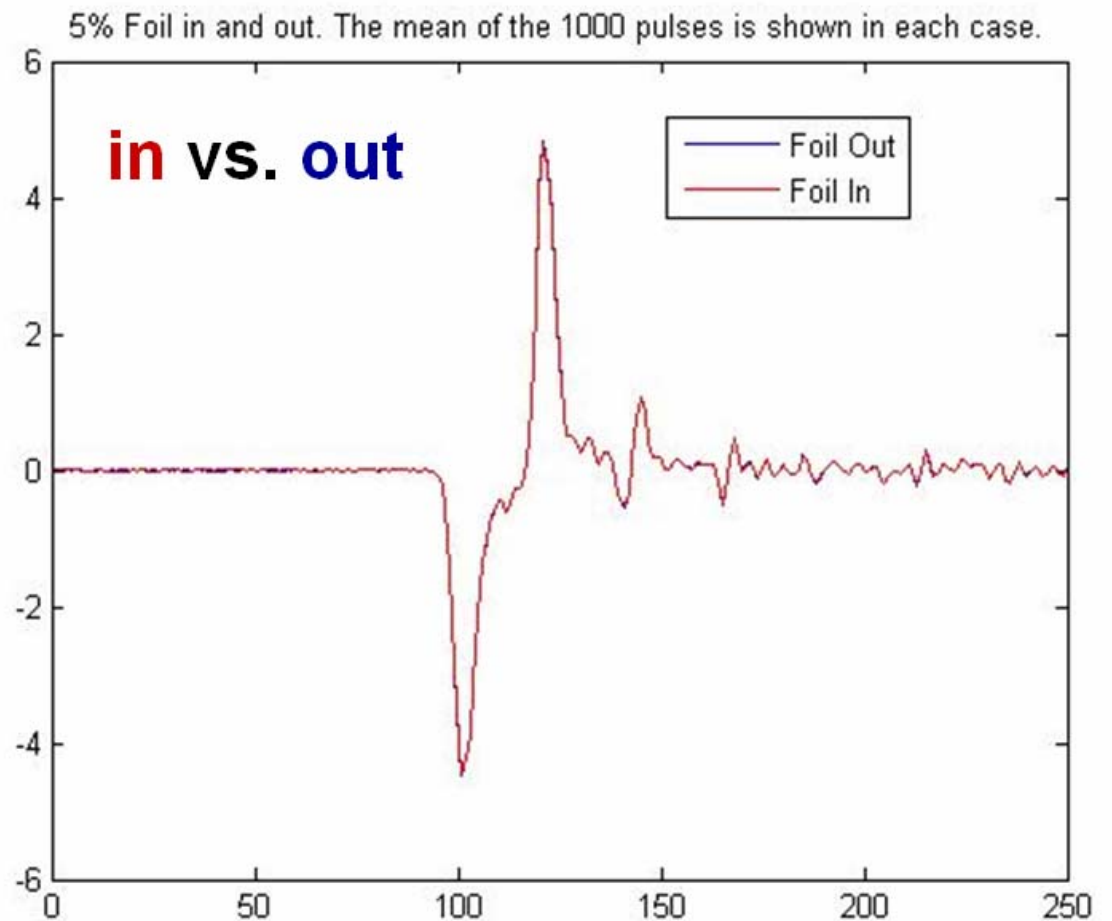
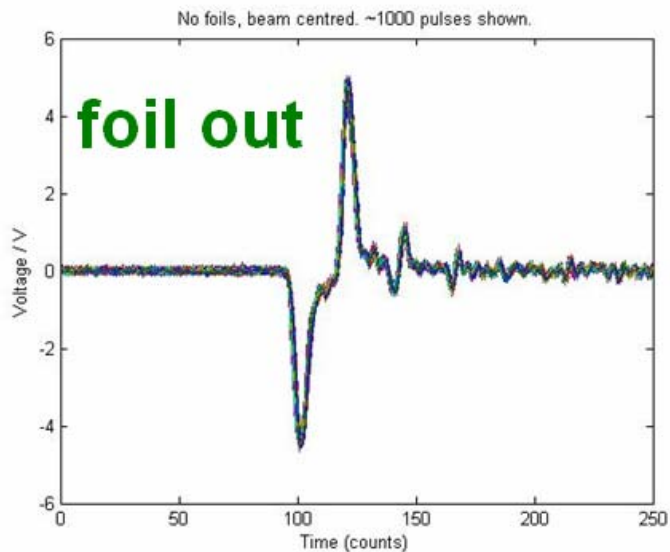
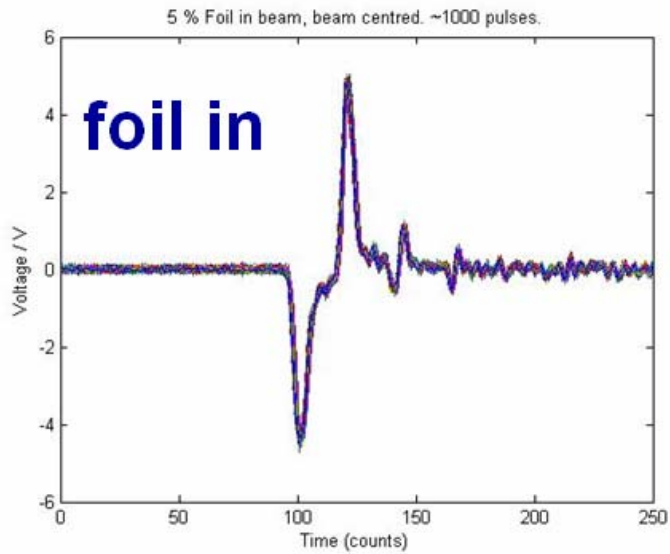

# Peak voltages foil in vs foil out

Foil thickness	Foil IN		Foil OUT	
	Mean / V	std / V	Mean / V	std / V
5%	3.99	0.09	4.00	0.09
3%	4.00	0.08		
1%	3.99	0.09	4.01	0.09

**See no effect within statistics (1000 pulses)**

**< 10 micron effect in position at ESA**

**< 100 nm at ILC**

**c.f. FB BPM resolution needed ~ few microns**

# Summary + conclusions

---

- **EM backgrounds were source of concern for operation of a feedback BPM in ILC interaction region**
- **Built a material model of ILC extraction line**
- **Used SLAC/ESA 28.5 GeV beam to simulate ILC EM bgds**
- **Developed simple BPM noise model; reproduces data**
- **Under background conditions c. 1000 x worse than ILC we saw no degradation of BPM operation**
  - < 100nm degradation in resolution at ILC**
- > current design of IP FB system looks robust**