

## SOLID STATE 2MW KLYSTRON POWER CONTROL SYSTEM

I. Roth, J. Casey, T. Hawkey, M. Gaudreau, M. Kempkes,  
Diversified Technologies, Inc.  
35 Wiggins Ave. Bedford, MA 01730 USA

### *Abstract*

Under an SBIR effort for the DOE, Diversified Technologies, Inc. designed, built, and installed a solid state power control system for the Advanced Light Source klystrons at Argonne National Laboratory (ANL). This system consists of two major elements – a 100 kV, 20 A CW solid state series switch, and a solid state voltage regulator for the mod-anode of the klystron. The series switch replaces the existing mercury ignitron crowbar, eliminating these environmentally hazardous components while providing enhanced arc protection and faster return to transmit. The mod-anode voltage regulator uses series IGBTs, operating in the linear regime, to provide highly rapid and accurate control of the mod-anode voltage, and therefore the output power from the klystron. Results from the installation and testing of this system at ANL will be presented.

### BACKGROUND

Crowbars are commonly used to protect Vacuum Electron Devices (VEDs) and other high voltage systems from arc damage. When an arc occurs, the crowbar closes, and rapidly discharges the energy-storage capacitor. The

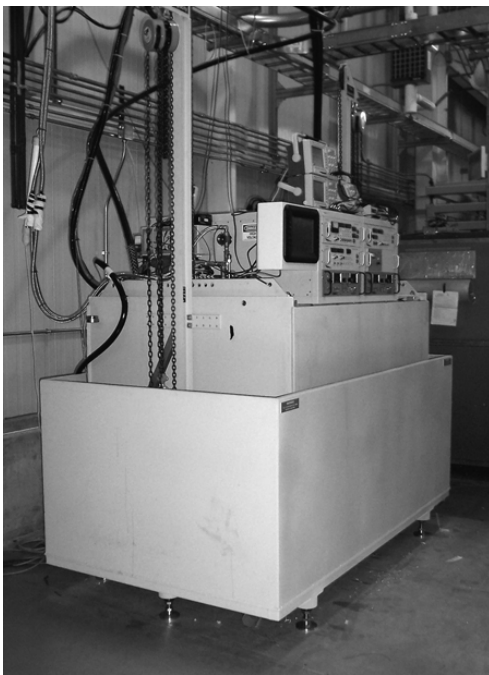

Figure 1: Klystron power control system installed at ANL.

upper part of Figure 1 shows a typical crowbar circuit, which shunts energy from the load. The disadvantages of this approach are well-known. The power supply, capacitors, and crowbar are subjected to very high currents and mechanical forces with every arc, and the entire power system must be reset after each arc. Using a solid-state switch can overcome these problems.

### LOAD PROTECTION USING A SOLID-STATE SWITCH

An alternative way to protect a high voltage load is to use a solid-state switch that opens during an arc, as shown in the lower diagram of Figure 1. In a pulsed system, this switch can also serve as the pulse modulator – when an arc occurs, the pulse is simply truncated. A solid-state switch, constructed from a number of IGBTs or FETs connected in series, can provide an ideal series opening switch for both pulsed and CW systems. Unlike a switch tube, which can also be used as a modulator, a solid-state switch is not subject to shoot-through when the load arcs. Because the power supply and capacitors are not discharged when the switch opens, operation can resume within tens to hundreds of microseconds.

The major limitation of solid-state switches is their finite current-handling capability. The key to using a solid-state switch as a crowbar replacement, therefore, is to ensure that the switch opens before the load current rises to high levels (which also minimize arc damage to the load). This is accomplished through very fast operation (on a microsecond timescale), and inductance within the circuit itself which limits the rate of current rise when an arc occurs.

#### *Arc Detection*

The simplest way to detect an arc is to monitor the load current with a current transformer. This approach, suitable for most pulsed and CW VED systems, detects the load current crossing a threshold when the switch is commanded to open. For a highly capacitive load, such as one with a long cable between the series switch and the load, blanking the arc detection signal for the initial microseconds of a pulse can prevent false arc detections, while maintaining a low current threshold for the majority of the pulse length. A more complex approach, suitable for fragile loads such as gridded systems, is to monitor both current and voltage, and declare an arc when the load current is rising and the load voltage is falling simultaneously.

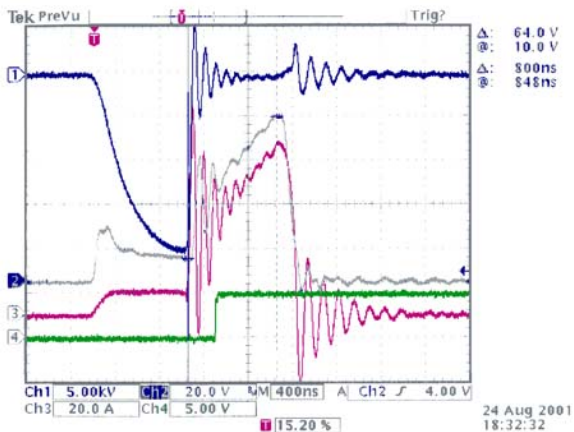

Figure 2: 50 kV klystron arc and opening switch response. Trace 1 – cathode voltage; Trace 2 – switch current; Trace 3 – cathode current; Trace 4 – switch controls signal. Power is removed at ~600 ns after arc onset. Total arc energy is << 1 J.

The time between fault sensing and switch opening in a pulsed system is approximately 700 ns, depending on the specific switch and controls configuration. This response is about five times faster than a conventional crowbar system, and dissipates several orders of magnitude less fault energy into the load. Lower fault energy dissipation can substantially extend VED lifetime. Figure 2 shows the response to an arc in a system installed at CPI.

After an arc, the switch can resume normal operation in less than 100  $\mu$ s - the actual time to operation depends primarily on the load recovery. This fast response can be of particularly high value in a military radar system, allowing a return to operation within a very short time. As a result of this crowbar elimination, RF systems with significantly higher reliability can be fielded in both new transmitter designs and through retrofits of existing systems.

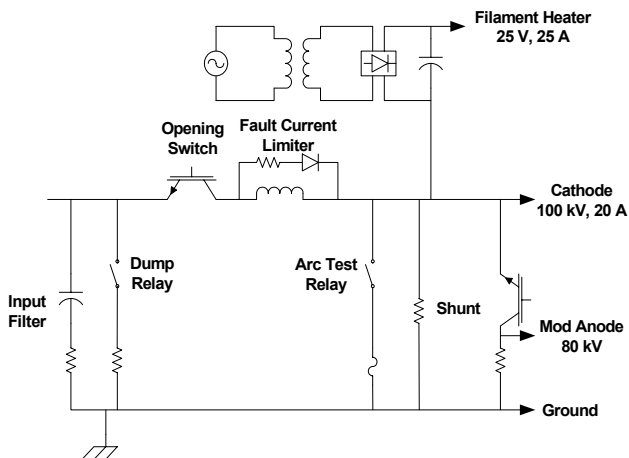

Figure 3: Solid-state switch schematic for the 100 kV, 100 A CW transmitter opening switch at the Advanced Photon Source.

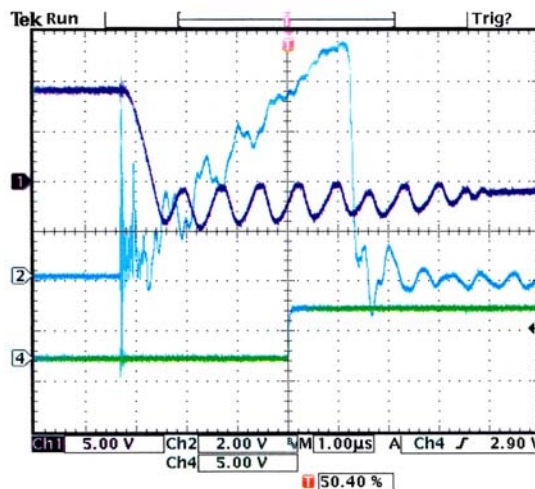

Figure 4: Opening switch arc response. Top trace: load voltage. Middle trace: load current. Bottom trace: switch control signal. The opening switch response time is 1.3  $\mu$ s after threshold crossing.

### ANL Opening Switch

Figure 3 shows the system schematic for an opening switch/crowbar system recently installed by DTI at Argonne National Laboratory (ANL). This 10 MW CW system, built under an SBIR for the Department of Energy, is designed to replace the mercury-ignitron crowbars that protect each of six large klystrons in the Advanced Light Source. Unlike the present crowbar system, the fast response of the switch and the retention of full charges in the capacitors during an arc may make it possible to retain a circulating beam in an accelerator after a klystron fault. In addition to the solid-state opening switch, this unit contains a solid-state, mod-anode voltage controller, capable of providing high bandwidth voltage adjustment to the mod anode as beam conditions change.

Figure 4 shows the response of the ANL CW system to a load arc. In this example, the current trip threshold is set at 200 A. The solid-state switch opens approximately 1.3  $\mu$ s after the current crosses this threshold. The current never rises above 250 A.

In a CW application, the forward voltage drop must be minimized to prevent power loss and overheating of the switch. Figure 5 shows the measured voltage drop of the 100 kV solid-state switch system, including snubbing and a small series resistance. This data, confirmed by calorimetry, shows that the total voltage drop across the system at 20 A is only 260 V, giving an efficiency of over 99.7% at full power (5.2 kW insertion losses out of 2 MW). The IGBTs themselves reach a steady-state junction temperature of only 54°C, giving very high reliability.

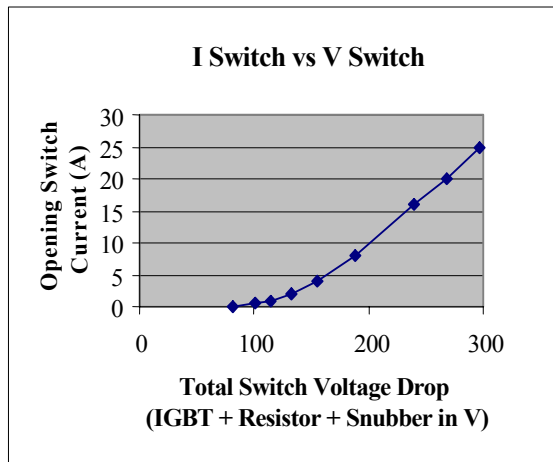

Figure 5: Voltage drop as a function of current in the 100 kV ANL switch. Efficiency at full current is 99.7%.

### MODULATING ANODE SUPPLY

The modulating-anode (or mod-anode) supply provides feedback from the circulating accelerator beam to the klystron. Previously to this, mod-anode supplies were made using vacuum tubes, which have a limited lifetime. DTI has developed a long-life solid-state mod anode supply.

The mod-anode supply is implemented as a resistor-transistor divider, which has simple controls and no crossover distortion. A simplified circuit diagram<sup>1</sup> is shown in Figure 6. The entire string comprises sixteen circuits, each made of ten IGBTs. Each 10-IGBT array is driven by a single photo-transistor connected to the gate of the bottom IGBT; the phototransistor is driven by a

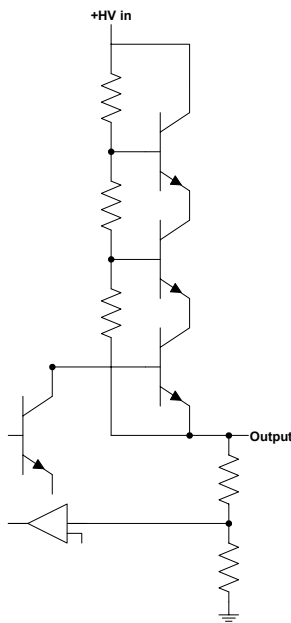

Figure 6: Simplified schematic of linear regulator.

fiber-optic cable. A sample voltage waveform is shown in Figure 8.

The full mod-anode supply has a minimum off-voltage of 3.6 kV. The slew rate of supply is limited by the load capacitance, 630 pF, and maximum current that can charge this capacitance without causing an over-current trip, 10 mA. These two quantities give a slew rate of 16 kV/ms in the cathode direction, and 12 kV/ms in the anode direction at a voltage of 30 kV between the mod anode and ground. The slew rates exceed the operational requirements.

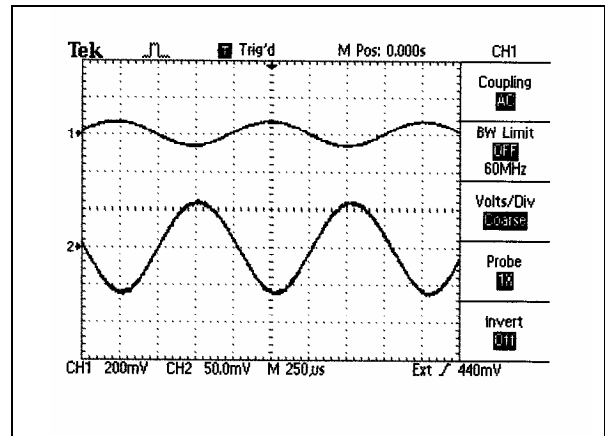

Figure 7: Linear voltage control. Top: 4 kV sinusoid in response to a signal generator sine wave input.

### CONCLUSION

A series solid-state switch opens rapidly in the event of a load arc, and returns the system to operation almost immediately after the arc clears. This extends the life of VED amplifiers, prevents damage to sensitive loads, and significantly enhances the reliability and operational value of a high voltage system. In combination with a solid state mod anode control system, this provides a highly reliable power control system for very high power CW klystrons. Similar, fully solid state power systems are also in operation for pulsed klystrons and gyrotrons at multiple sites around the world.

<sup>1</sup> See, for instance, Horowitz and Hill, *The Art of Electronics, Second Edition*, pp. 371-2. Cambridge University Press, 1989