

RESULTS FROM DR AND INSTRUMENTATION TEST FACILITIES *

Junji Urakawa

High Energy Accelerator Research Organization(KEK), 1-1 Oho, Tsukuba-shi, Ibaraki, Japan

Abstract

The KEK Accelerator Test Facility (ATF) is a 1.3GeV storage ring capable of producing ultra-low emittance electron beams and has a beam extraction line for ILC R&D. The ATF has proven to be an ideal place for researches with small, stable beams. 2×10^{10} single bunch and low current 20 bunch-train with 2.8nsec bunch spacing have been extracted to develop Nano-Cavity BPM's, FONT, Nano Beam Orbit handling (FEATHER), Optical Diffraction Radiation (ODR) monitor, a precision multi-bunch laser-based beam profile monitor and polarized positron beam generation via backward-Compton scattering by the international collaboration. A set of three cavity BPM's is installed in the ATF extraction line on a set of extremely stiff supports. The KEK group installed another set of three BPM's, with their own support mechanism. The full set of 6 will prove extremely useful. In the DR (Damping Ring), we are researching the fast ion instability, micro-wave instability with four sets of damping wiggler and developing pulsed laser wire monitor, X-ray SR monitor, very fast kicker with about 1nsec rise/fall time to make ILC beam. I will report the recent results on above R&D's.

OUTLINE OF ATF AT KEK

The Accelerator Test Facility (ATF) at KEK consists of three major parts: an S-band injector linac, a damping ring, and a beam diagnostic section(EXT) (see Fig. 1) [1]. Each part directly contributes to the development of technologies relevant to high luminosity linear colliders. The ATF has been designed to investigate the feasibility of the LC operation scheme and to develop beam-control techniques for the LC [2, 3, 4]. The multibunch scheme is essential to boost the rf-to-beam transfer power efficiency in the accelerator.

The ATF generates, accelerates, damps, and extracts a train of 20 bunches with 1×10^{10} electrons/bunch and 2.8ns spacing. The goal is to achieve a normalized emittance of $2.5 \mu\text{m}$ horizontal and $0.0125 \mu\text{m}$ vertical and a 0.08% energy spread for the multibunch beam. The small emittance from the damping ring has been achieved by special design of a strong focusing lattice with precise alignment of components and beam orbit control. The nonlinear behavior of the beam has to be well understood to provide enough dynamic aperture under such strong focusing conditions. The layout of the EXT for precise beam diagnostics is shown in Figure 2.

* junji.urakawa@kek.jp

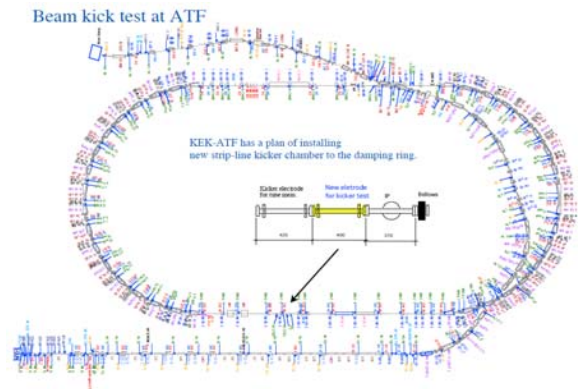

Figure 1: The Accelerator Test Facility(ATF) at KEK

RESULTS IN ATF

Emittance Measurements at the EXT

Intensive studies on the vertical emittance with the wire scanners in the EXT have been ongoing since March(2000)[5]. An important observation we made during this time is that there appears to be a source of x-y cross plane coupling somewhere between the extraction point of the damping ring (DR) and the wire scanner region in the EXT. The measured vertical emittance is approximately $(1.1 \pm 0.1) \times 10^{-11}$ m for the beam intensity of $(2.0 \pm 0.2) \times 10^9$ electrons per bunch. This represents the best result so far obtained at the EXT in a single-bunch mode operation. The emittance is found to grow to $(2.2 \pm 0.1) \times 10^{-11}$ m at the beam intensity of $(8.0 \pm 0.3) \times 10^9$ electrons per bunch, however. This could be due to effects of the intra-beam scattering, which according to a simulation can lead to an emittance growth of about 50% at this bunch intensity. More careful theoretical and experimental studies are needed to fully understand the situation. In these measurements, the x-y beam profile showed a tilting of a few degrees, as observed by using 10 degree wires. The quoted vertical emittance in these plots might be further reduced by re-optimizing the setting of skew magnets. Obviously, repeated measurements and careful studies are needed, and the results shown here should be considered preliminary. It appears that the following points play an important role.

1. Tuning with skew knobs in the arc sections of the DR for reducing the betatron coupling in the ring.
2. Careful corrections for residual dispersion in the EXT.
3. Additional cross-plane coupling correction using a skew quadrupole magnet in the EXT, upstream of the wire scanners.

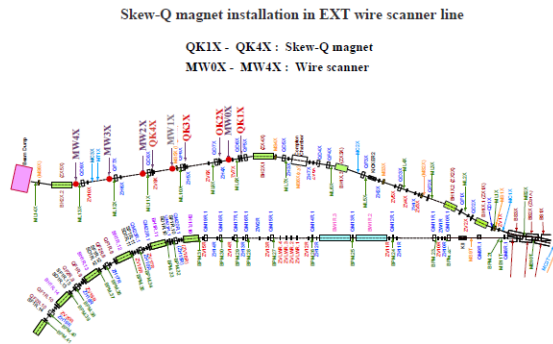

Figure 2: The layout of the extraction line.

Magnet Alignment in Damping Ring

The damping ring uses many active girders for the beam based alignment. This system is not yet completed. One active girder in the arc section supports one combined bending magnet, two quads and two sextupoles. About 300 magnets for ATF damping ring were aligned within the accuracy of 100 μ m (peak-to-peak) until now. Since main magnets on the active girder in the arc section are set within the accuracy of 37 μ m (r.m.s.), we can align them precisely using beam based alignment and movers. The scattered plot on setting error of transverse position and longitudinal setting error are shown in Figure 3.

Also, the ring circumference has been measured. Figure 4 shows difference between measured circumference and design one of the damping ring. We have changed rf frequency in the range of 20kHz to -20kHz because of keeping the centered beam orbit in the arc-sections. This corresponds the circumference change of the ring in the range of -3mm to 3mm. The circumference expands until Aug. by 6mm and shrinks to measured values on Jan. when we started operation of the ring 1997. Rate of concrete expansion is about 10⁻⁵/degree. Thermal expansion is main source of this problem because calculated values is consistent with measurements.

Beam Tuning and Diagnostics in Damping Ring

COD and Dispersion The program SAD is used in orbit and dispersion corrections, for calculating new setting of the steering magnets. The COD correction in DR was satisfactory, but the results were 2mm (peak to peak) horizontally with 1mm expected from simulations and 1mm vertically. The reason may be misalignment of magnets, errors in the optics model (especially non-linearity) and error of BPMs. The dispersion in the DR is measured as difference of orbits with different RF frequencies. The dispersion correction in the ring worked and typical r.m.s. of the vertical dispersion after the correction was about 5 mm which is close to our target.

X-Y Coupling To correct x-y coupling, trim coils of the all sextupole magnets are connected to produce skew quadrupole field. A global correction of the coupling is essential to achieve the smaller emittance. We tried a global coupling correction minimizing vertical COD

response to horizontal steering. The orbit coupling was clearly reduced and some reduction of the vertical emittance was observed after the correction. We also tried a coupling correction by 4 dedicated skew quadrupoles and achieved some reduction in the vertical beam size at the SR source point.

Local orbit bumps were also used for low vertical emittance. Setting many bumps one-by-one the vertical beam size was monitored using SR-interferometer. Probably, the resolution (or stability) of the monitor was not enough for this tuning technique.

Assembly Result of Magnets on Mover Table Transverse Direction

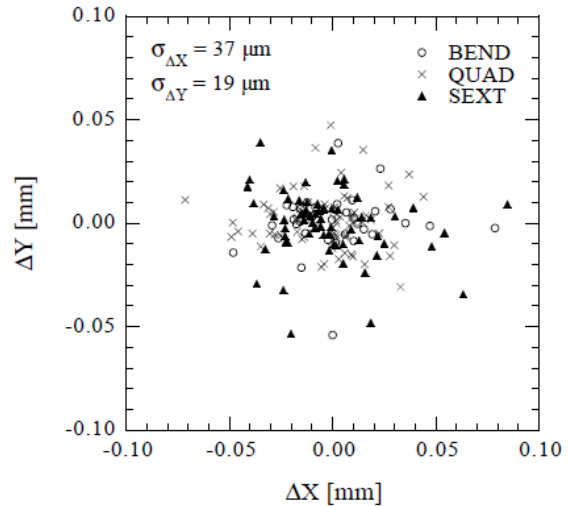

Assembly Result of Magnets on Mover Table Longitudinal Direction

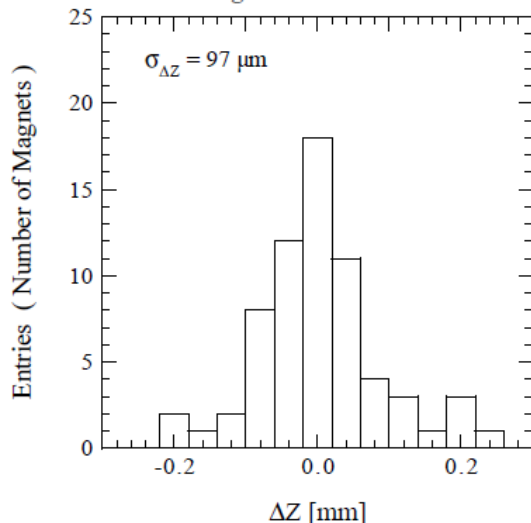

Figure 3: Scattered plot on transverse setting error and longitudinal setting error which were measured on magnets of the ATF 14 active girders using a 3D mobile tracking system.

We tried new coupling correction using orbit response matrix (ORM) analysis. It has been confirmed that ORM analysis is a technique used to diagnose and correct optics errors in storage rings. Recently, we achieved and confirmed the normalized vertical emittance of 0.015 μ m at a bunch charge of (7.0 \pm 0.2) \times 10⁹ electrons in the ATF

ring by ORM analysis and the laser wire monitor [6].

Optics Diagnostics The error in the original estimation of the quadrupole field of each type of the quadrupole magnets was calculated from the response to beam-orbit change and the model was corrected. The errors of some types of magnets were as large as 2%. We measured the R_{12} single-pass response matrix of each

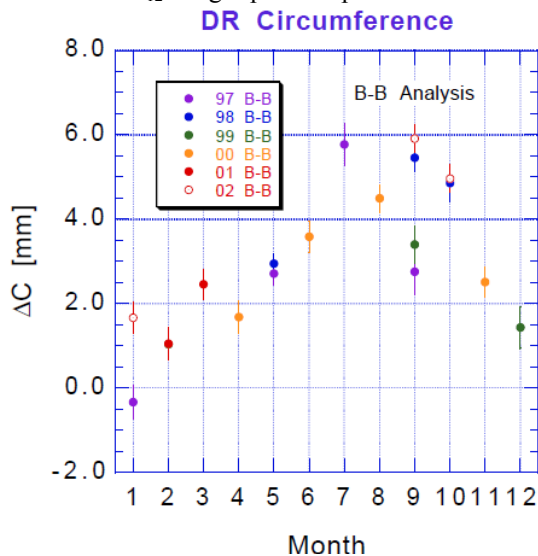

Figure 4: Change of Damping Ring Circumference, Horizontal axis indicates month on which the circumference was measured. Vertical axis is the difference between measured values and design one.

BPM to excitations of the different dipole correctors, with sextupole magnets turned off. From these data we calculated typical quadrupole field-strength errors of about 1% and upgraded the optics model so as to account for these errors, which arise from an interference effect between adjacent magnets. The magnetic-field difference between the upgraded model and new beam-based measurements are less than 0.01%.

INSTRUMENTATION R&D FOR ILC AT ATF/ATF2

Beam Position Monitors

The most important instrumentation for the beam control is beam position monitors (BPM), which measure the transverse positions of the beam centroid. The capability requirements for the BPM at ILC include: a single pass measurement, an average position measurement for a multibunch beam, high resolution, and high accuracy. High precision orbit control of the order of several μm is required for the beamlines and accelerators downstream of the main damping rings. The Cavity BPM technology is applied for these high resolution, high accuracy BPMs. In other areas, the precision requirement is relaxed to several $10\mu\text{m}$. Strip line BPMs and the button BPMs are used for them.

Stripline BPM This BPM is used in Linacs and the beam transport lines upstream of the main damping rings.

It is also used in the arc sections of the bunch compressors. This BPM has 50Ω strip lines with one shorted end. In upstream linacs a BPM is directly mounted on a quadrupole magnet, as shown in Fig. 5. The expected resolution for beam position measurement is $2\mu\text{m}$. The deviation in the electrical center of a BPM from its quadrupole center is controlled to within $50\mu\text{m}$. This includes the effects of the calibration accuracy of the

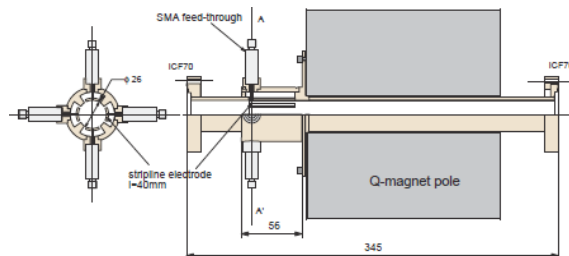

Figure 5: Stripline BPM.

mechanical and electrical offsets, the stability of the electrode position, as well as the stability of the signal processing electronics. A calibration method with a singing wire is applied after each BPM is installed on its quadrupole magnet. The electronics will be equipped with a self-calibration system, too. The read-out system employs a base line clipping circuit and a charge ADC for good performance and low cost.

Button BPM for DR In the main damping rings, button type electrode BPMs are used, since they can fit within a small space and offer a relatively low coupling impedance to the beam. Fig. 6 shows their schematic design.

The DR BPMs are welded onto the vacuum chamber. Calibrations of the BPM offset and position mapping are done, after the vacuum chamber assembly is completed, by using a long rigid antenna. For signal processing, the same electronics system as that for the stripline BPMs will be used for the button BPMs. The resolution and accuracy of the button BPMs are expected to be comparable to that of the strip line BPMs: $2\mu\text{m}$ for resolution and $50\mu\text{m}$ for the absolute accuracy.

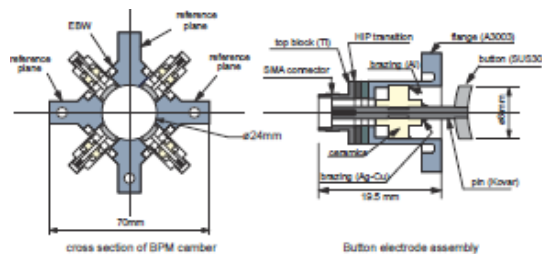

Figure 6: DR button BPM.

Cavity BPM at BDIR (Beam Delivery & Interaction Region) For BPMs in the BDIR area, a mechanical stability of $1\mu\text{m}$ or better in any time scale is required during operation. The Cavity BPMs based on a microwave cylindrical cavity have a much more rigid

structure than other BPMs. Consequently, a superior long-term mechanical stability is expected, and the Cavity BPMs are considered to be suited for deployment in this area. Their resolution is $0.1 \mu\text{m}$ over a measurement range of $\pm 50 \mu\text{m}$. The absolute accuracy is $10 \mu\text{m}$. Since the sensor cavity and its outer surface has a concentric, cylindrical shape, their centers can be determined within

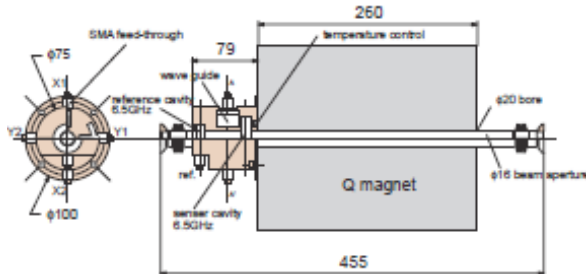

Figure 7: Cavity BPM at a Q magnet.

a few μm . The installation into the quadrupole magnet, as shown in Fig. 7, and the calibration of the BPM center to the magnetic center is done to an accuracy of $10 \mu\text{m}$. The singing wire method determines the magnetic center, and an external coordinate machine correlates it to the BPM outer surface, which is the reference surface of the BPM.

Temperature control is essential for maintaining the mechanical stability. The BPM temperature is affected by the ambient temperature and heat from the quadrupole magnet. An electrical temperature controller with a ± 0.1 degree accuracy is installed in the BPM body. Drifts of the BPM offset due to common mode contaminations are suppressed by employing the slot magnetic coupling and the external suppressor circuit using two port combiner. The frequency of the difference mode in the sensor cavity is chosen to be 6.5 GHz, since it has no relation to any accelerator frequency.

This allows one to avoid interference into the circuit. The detection circuit consists of a synchronous phase detector with the reference cavity pickup, a pulse stretching amplifier, a diode amplitude detector, a pulse amplifier and a 16 bit track-hold ADC.

Beam Size Monitors

Carbon-wire scanner The use of destructive beam size monitor should be avoided in the accelerator, because of the high power beam and the high radiation yield. A carbon wire scanner is a reliable and precise beam size monitor with a small disturbance. The beam power is sufficiently high to break a tungsten wire; a carbon wire of $7 \mu\text{m}$ diameter can withstand it. Monitors are installed in several places, with 4 scanners set upstream of the damping ring.

The scanner chamber and its mechanics are the same as the ATF wire scanner. They have a $0.5 \mu\text{m}$ mover resolution and a $0.5 \mu\text{m}$ wire position read back resolution. The carbon wires are stretched as shown in Fig. 8. A gamma-ray detector placed downstream of the scanner detects gamma rays from beam-wire interaction.

Laser-wire scanner Downstream of the main damping ring, the beam size becomes very small (around $100 \times 10 \mu\text{m}$), while the bunch charge remains the same. Since the carbon wire cannot withstand the condition in such a high density beam, a laser wire scanner is used there as a non-break wire. The laser wire is produced in

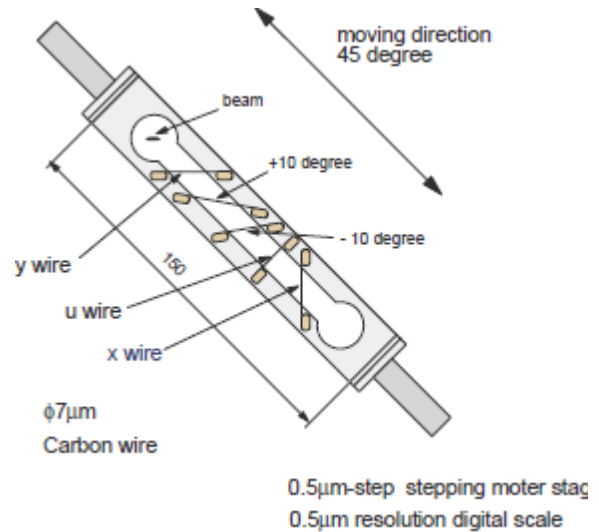

Figure 8: Carbon wire mount in the wire scanner.

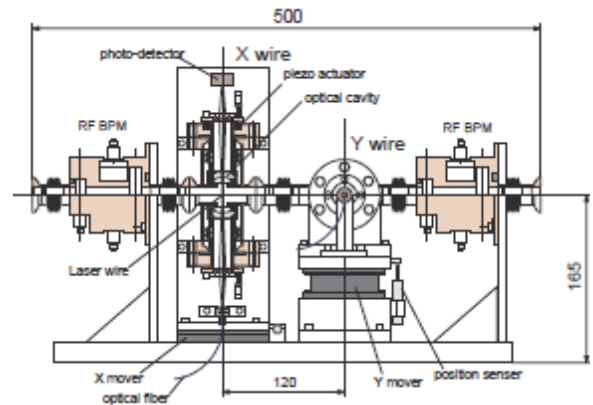

Figure 9: Laser wire scanner.

the optical cavity, while keeping in resonance by a piezo-mirror control. The laser wire chamber consists of x and y laser wires and Cavity BPM on both sides, as shown in Fig. 9. The wire is moved together with the chamber within the bellows stretching limit. The mover resolution is $0.5 \mu\text{m}$. Since the yield of the generated gamma-ray is much less than the carbon wire, the scanning time will be much longer, like 1 or 2 minutes for one profile. The gamma-ray detector is the same as that of the carbon wires [7].

On the other hand, we have the possibility on another laser wire using high power pulsed laser system like SLC laser wire [8].

Laser interference monitor at I.P. Direct monitoring of the beam size of the interaction point is

only required during the machine startup time. After the detector facility rolls in, the colliding beam size is monitored by others methods, such as the beam-beam deflection technique. The laser interference monitor uses the interaction of the beam with laser interference fringe, and observes the gamma-ray modulation by scanning the beam. This monitor was already demonstrated while detecting a 60 nm beam size in the FFTB experiment[9].

ODR monitor Optical diffraction radiation (ODR) appearing when a charged particle moves in the vicinity of a medium is a very promising effect for beam-size and bunch length monitoring. Two cones propagate in the direction of specula reflection producing an interference pattern, which is very sensitive to the transversal beam parameters. Since the particles do not directly interact with the target it allows keeping the beam parameters almost the same as the initial ones[10].

For the tuning and monitoring of the bunch compressor, a bunch length monitor with a 10 μ m (30fs) resolution is required. The spectrum reconstruction monitor in the infra-red region is used for the 100 μ m bunch length measurement since ODR becomes the coherent radiation in the infra-red region according to the length of short bunch. We are developing the microwave detector for the study of CSR instability at ATF.

Polarized positron beam generation The proof of principle experiment for polarized positron beam generation based on backward-Compton scattering has been done at the EXT. Almost 100% circular polarized gamma-ray was generated at about 56MeV with 2.2x10⁷ photons/collision. The polarization of the positron beam which was generated through the process of pair-creation at the gamma-ray target has been measured by the transmission method of gamma-ray related Compton scattering in magnetized iron. Detail report will be published soon[11].

Nano-Cavity BPM's, FONT, Nano Beam Orbit Handling (FEATHER)

A set of three cavity BPM's is installed in the ATF extraction line on a set of extremely stiff supports by LLNL and SLAC. The KEK group installed another set of three BPM's, with their own support mechanism. Other international group installed the strip-line kicker to handle beam orbit within a few nano-meter level. The full set of 6 and the kicker will prove extremely useful to develop them. They are mutually related and have been proceeded at the EXT by international groups. So far they have achieved the resolution of about 20nm(rms) and a few nm is the target value for the beam orbit feedback in the IR[12].

ATF2

ATF2 aims to focus the beam down to a few tens of nm(rms) with a beam centroid stability within a few nm for a prolonged period of time. Detail report of the ATF2 is given in [13]. Development of above monitors and beam tuning method will be established during the experiments of ATF2 international collaboration. Both the

ATF and ATF2 will be managed to serve the mission of providing the young scientists and engineers with training opportunities in R&D programs for advanced accelerator technologies.

Present Status of Damping Wiggler, Fast Kicker and Beam Instability Studies

We have measured the damping time and horizontal emittance reduction due to effect of the damping wigglers. They were consistent with calculated values and 6pmrad vertical emittance was achieved[14]. Also, R&D on fast kicker is going to check the performance of the system with 2.8ns 20-bunch train. Preliminary results indicate the possibility of beam extraction without kick effect into adjacent bunch. We consider more detail study of the system is necessary.

The fast ion instability, micro-wave instability and non-linear beam dynamics studies are underway to obtain important information for ILC damping ring design. Several international groups already proposed the plan and we are discussing the details on each study soon.

ACKNOWLEDGEMENTS

The authors would like to thank Professors Y.Totsuka, F.Takasaki, Y.Kamiya, K.Yokoya, S.Kurokawa, and A.Enomoto for their encouragement. All members of KEK-ATF group and international collaborators for this research program are acknowledged. We also thank Professor E.Paterson and Professor D.Burke of SLAC and Dr. K.Hubner of CERN for supporting the ATF project as an international collaboration.

REFERENCES

- [1] Edited by F.Hinode, et al., KEK Internal 95-4, June 1995.
- [2] J.Urakawa, KEK/ATF Damping Ring, PAC97, pp.444-448, Vancouver, May 1997.
- [3] Edited by H.Hayano et al., KEK Internal 2000-6 A (2000).
- [4] J.Urakawa et al., presented at 17th International Conference on High-Energy Accelerators (HEACC98), Dubna, Russia, 7-12 Sep. 1998. KEK Preprint 98-154.
- [5] J.Urakawa, H.Hayano and M.Ross, Proc. of Nanobeam 2002, p223.
- [6] A.Wolski et al., ATF Reports-04-09, LBNL-57046, SLAC PUB-11040, 2004.
- [7] Y.Honda et al., Physical Review Letters, Vol.92, No.5, 054602-1 (2004).
- [8] M.Ross, LINAC96, Proc., p.308., G.Blair, Private communication.
- [9] V.Balakin et al., Physical Review Letters, Vol.74, No.13, pp2479-2482 (1995).
- [10] G.Naumenko, et al., Proc. of this conference.
- [11] T.Omori, et al., to be submitted.
- [12] P.Burrows, M.Ross et al., Private communications.
- [13] H.Hayano et al., Proc. of this conference.
- [14] T.Naito et al., Proc. of this conference.