

## BUNCH PURITY EVOLUTION DURING APS STORAGE RING TOP-UP OPERATIONS\*

A.H. Lumpkin<sup>†</sup>, C.-Y. Yao, B.X. Yang, and T. Toellner  
Advanced Photon Source, Argonne National Laboratory  
Argonne, Illinois 60439 USA

### *Abstract*

During top-up operations of the Advanced Photon Source (APS) storage ring, a growth of the charge in the buckets on the trailing time side of the target rf buckets was observed in the bunch purity monitor data. This system is based on a photon counting technique that provides sub-ns time resolution with a dynamic range of greater than  $10^6$ . The satellite bucket growth was related to the number of linac bunches being injected into the particle accumulator ring (PAR) and the adjustment of the 12<sup>th</sup> harmonic rf cavity phase. Besides measuring this growth in the +3,+1 buckets relative to the 22 singlets targeted during top-up, we also report a special configuration and extended counting period that detected charge at the  $10^{-9}$  level of the target bucket.

### INTRODUCTION

The Advanced Photon Source (APS) storage ring serves as a national hard x-ray synchrotron user facility [1]. In addition to the requirements of high brilliance of hard x rays, beam stability at the few-micron rms jitter level, and >95% availability, the bucket purity of the fill pattern is monitored at the one part in a million level. The timing experiment users (e.g., nuclear resonance experiments) request that the adjacent bucket charge/intensity on the trailing time side (+) of the target rf buckets should be less than  $10^{-6}$  of the target bunch. This is particularly relevant when the fill pattern is nominally 1+22 singlets with the 22 singlets spaced by 54 rf buckets (352 MHz rf fundamental). Any charge in the buckets on the late side becomes a background source to the experiments triggered by the target buckets. The bunch purity measurement is done by the standard photon counting system based on a fast x-ray avalanche photodiode (APD), timing electronics, and an analog-to-digital converter (ADC) linked to the EPICS system. Although bunch purity is very stable in our injections done at 12-hour intervals, our system detected a change in the bunch purity of the +1 bucket during top-up operations where single-shot injection occurs every two minutes. We have traced this to the change in the number of linac bunches selected for injection into the particle accumulator ring (PAR) and the adjustments of the PAR 12<sup>th</sup> harmonic rf phase during top-up. Examples of the bunch purity measurements from a standard fill and the evolution during top-up will be shown.

\*Work supported by U.S. Department of Energy, Office of Basic Energy Sciences, under Contract No. W-31-109-ENG-38.  
<sup>†</sup>lumpkin@aps.anl.gov

### EXPERIMENTAL BACKGROUND

Some background about the injector and the bunch purity system will now be presented.

#### *APS Injector System*

The APS uses an S-band linac to accelerate electrons from the rf thermionic gun. The electron beam macropulse is about 8 ns long and typically includes about 1 nC of charge. The beam energy is 325 MeV at the end of the linac, and this beam is accumulated in the PAR at up to a 30-Hz rate. The number of macropulses can be selected from 1 to 6. The beam is damped in the PAR with the assistance of a 12<sup>th</sup> harmonic cavity at 117.3 MHz. The beam is extracted at a 2-Hz rate and injected into the injector synchrotron (IS), which ramps the energy up to 7 GeV in a 200-ms time period. Extraction from the booster and injection into the storage ring (SR) also can occur at a 2-Hz rate under standard conditions, such as a fill from zero charge or a fill-on-fill procedure done at 12-h intervals. However, for top-up operations with the 1+22 singlets pattern and low effective emittance of about 2.9 nm-rad, the charge from the injection is added in one shot every two minutes. In order to compensate for the shorter lifetime of the latter fill pattern,  $\sim 2.8$  nC per shot is needed so more linac bunches are selected to inject into the PAR. Initially there was no procedure to retune the PAR rf for this beam loading change.

#### *The Bunch Purity Monitor*

The bunch purity monitor is based on the standard photon counting system [2,3], which uses a fast x-ray APD, timing electronics, a time-to-amplitude converter (TAC), and an ADC linked to the EPICS system. A bunch clock generator built by the APS Controls Group provides a timing reference for each of the buckets targeted for charge in the prescribed fill pattern. A schematic of the system is shown in Fig. 1. X rays emitted by the beam as it transits an upstream dipole magnet are transported through a pinhole aperture to a stainless steel scattering foil. The APD is at 90° to the x-ray beam direction and positioned by a remotely controlled translation stage. The x-ray arrival times are compared in the TAC to these bunch clock signals. The multichannel analysis (MCA) time spectrum is the average of the bucket purity adjacent to each of the targeted singlets. Count rates in the detector of 80 kc/s result in the  $10^6$  counts in the target peak after 300 s. Due to the PAR's 12<sup>th</sup> harmonic being one third of the IS and SR fundamental frequency, it is possible for charge to

appear in the  $\pm 3$  bucket position. The +1 bucket is usually very weakly populated unless there are timing drifts in the 12<sup>th</sup> harmonic phase.

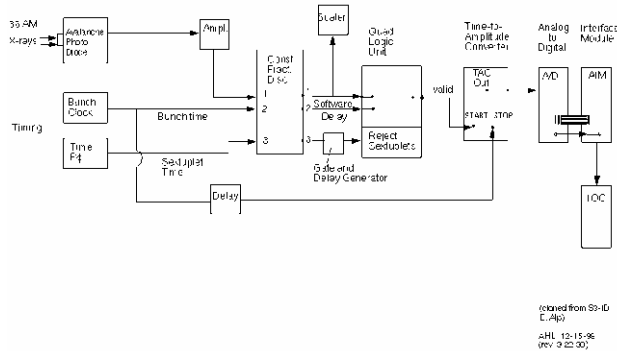

Figure 1: A schematic of the photon counting electronics layout for the bunch purity monitor.

## EXPERIMENTAL RESULTS

### Top-Up Operations

The initial observations of bucket purity degradation occurred after the top-up operations became routine in the Fall of 2001. The bucket purity was better than  $10^{-6}$  at the +1 and +3 buckets just after filling from zero current to 100 mA, as shown in Fig. 2. However, within eight hours the bucket purity was measurably degraded to about  $5 \times 10^{-5}$ . In a later run this degradation of the +1 and +3 buckets reached the  $10^{-5}$  level after 98 hours as shown in Fig. 3. The nominal operations guideline is to maintain the bunch purity ratio better than  $10^{-5}$ .

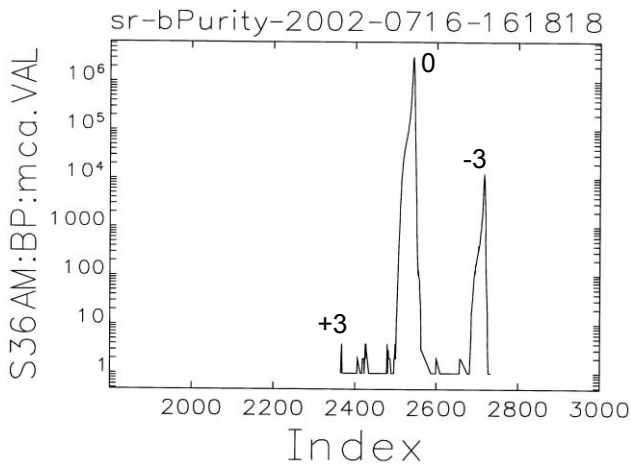

Figure 2: An example of the bunch purity measurement from the MCA showing the dominant signal on the target bucket and the minimal signal on the late time side (left) after the fill from zero current.

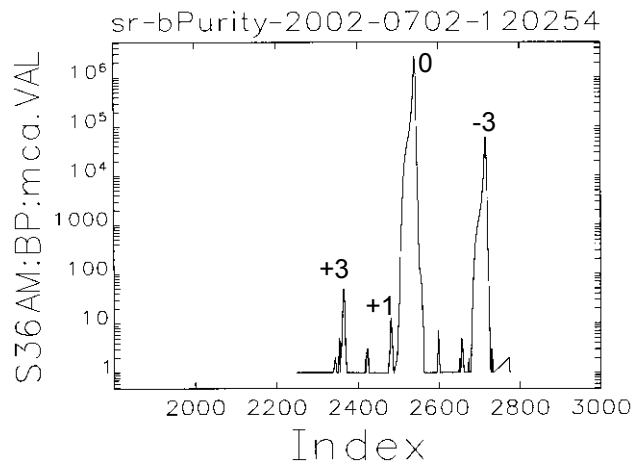

Figure 3: An example of the bunch purity measurement from the MCA after 98 hours of top-up operations. The growth of the +1 and +3 bucket intensity is to a level of about  $10^{-5}$  of the target bucket.

### Controlled Experiments

Studies were conducted to investigate the difference in the injection procedure between initial fills and top-up. It was recognized that the initial fill was done by injection only one or two linac macropulses into the PAR, but for top-up the operators switched to three or four linac macropulses. The PAR 12<sup>th</sup> harmonic rf was usually optimized for the first injection scenario, but not the second. We were able to demonstrate this by dedicated studies with the injector and storage ring on several occasions. We filled the storage ring to 102 mA each time using two, three, four, and five linac bunches selected for injection into the PAR. The two-bunch case is particularly clean as shown in Fig. 4. The four-bunch case is shown in Fig. 5. There is significant +1 impurity at the  $10^{-4}$  level. For the four- and five-bunch cases we obtained a large +1 bucket impurity, which indicates an instability in the PAR rf system (since the 12th harmonic of the PAR is 1/3 of the SR rf frequency). We were also able to clean these impurities by selectively driving the weak bunches into a scraper blade. This test was done partly to develop the capability to clean the impure buckets and partly to demonstrate the signals were bunch-charge related and not electronic noise (see Fig. 6). The 12<sup>th</sup> harmonic function generator has been changed and retuned to provide better damping of the beam and better phase stability. The growth of the satellite buckets has been reduced during top-up operations with these steps.

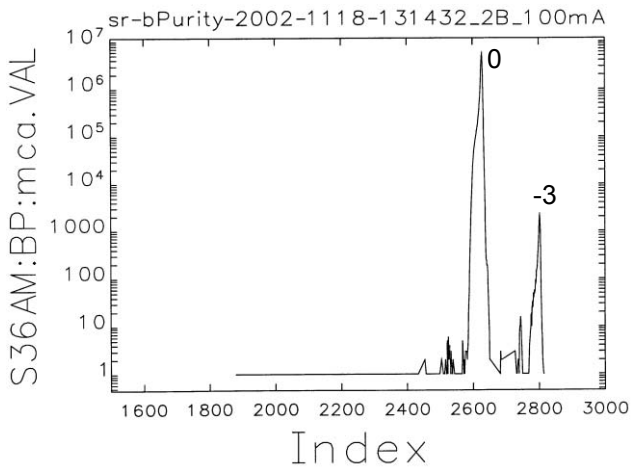

Figure 4: An example of the bunch purity measurement from the MCA using two linac bunches per cycle into the PAR. Bunch purity is nominal.

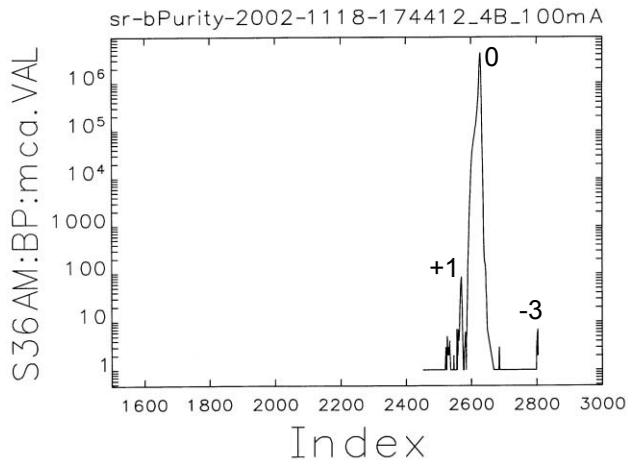

Figure 5: An example of the bunch purity from the MCA using four linac bunches per cycle (1/2 s) into the PAR. Bunch purity is degraded noticeably.

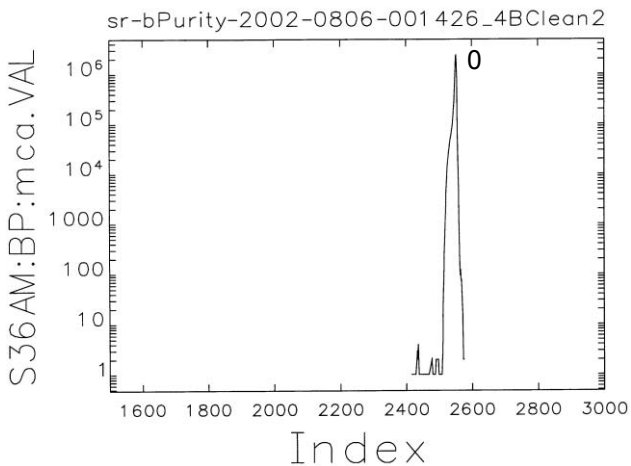

Figure 6: An example of the bunch purity from the MCA after bunch cleaning using a resonantly driven beam oscillation.

### Ultrahigh Bucket Purity

During the course of these tests, an additional effect was reported by a user experiment on very small intensities ( $10^{-9}$  level) in the satellites 32-36 buckets away from the target singlets [4]. This effect appeared to have some correlation with the +1 and +3 bucket growth. We opened up the pinhole aperture upstream of the APD and moved the detector closer to the scattering foil to obtain count rates of about 500 k per second. We also integrated the MCA data over a 24-hour period. We were able to confirm trace charges in these far away buckets (which are close to one period of the PAR) at the  $10^{-9}$  level as shown in Fig. 7.

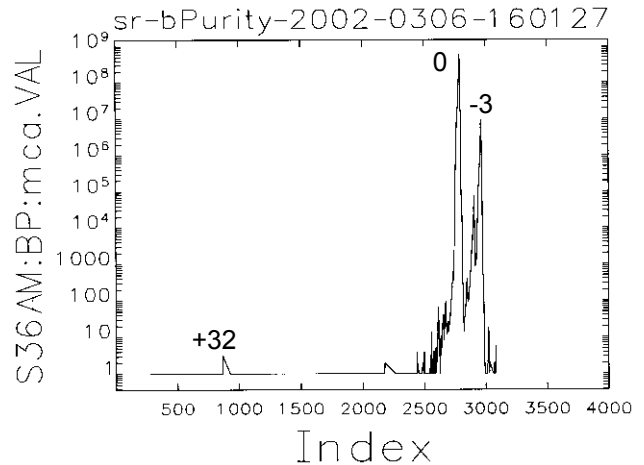

Figure 7: An example of the bunch purity from the MCA with statistics to the  $10^9$  range. There are a few counts at the +32 bucket position.

### SUMMARY

In summary, we have used the bunch purity system to identify a degradation of the bunch purity during top-up operations. Controlled experiments were used to verify their source, and an improved tuning of the PAR's 12<sup>th</sup> harmonic phase has reduced the effect. We also demonstrated the ability to measure satellite impurity to the  $10^{-9}$  level.

### REFERENCES

- [1] J.N. Galayda, "The Advanced Photon Source," Proc. of the 1995 Particle Accelerator Conference, IEEE, Vol. 1, pp. 4-8 (1996).
- [2] J. Revol (ESRF), private communication (May 1998).
- [3] E. Alp and T. Toellner (Argonne National Laboratory), private communication (September 1999).
- [4] W. Sturhahn (Argonne National Laboratory), private communication (March 2002).