

NUMERICAL SIMULATION OF THE ALBA SYNCHROTRON LIGHT SOURCE COOLING SYSTEM RESPONSE FOR FAILURE PREVENTION

X. Escaler^{*}, Universitat Politècnica de Catalunya, Barcelona, Spain
J.J. Casas[†], C. Colldelram[‡], M. Quispe[§], M. Prieto[#], ALBA Synchrotron Light Source, Cerdanyola del Vallés, Spain

Abstract

The ALBA Synchrotron Light Source cooling system is designed with a common return pipe that interconnects the four consumption rings. Such configuration is believed to compromise its optimal operation. To understand its thermo-fluid dynamic behaviour, a detailed 1D model has been built comprising all the components such as the pipes, fittings, bends, valves, pumping stations, heat exchangers and so on, and the various regulation mechanisms. Preliminarily, the model results in steady state operating conditions have been compared with experimental measurements and the maximum deviations have been found below 13%. Then, a series of transient numerical simulations have been carried out to determine the system response. Specifically, effects of the blockage and leakage of a consumption line as well as the increase and decrease of heat duty for the tunnel rings have been investigated. As a result, the stability of the system has been evaluated and the operational limits have been estimated in front of hydraulic and thermal load variations. Moreover, particular behaviours have been identified which can be used to design monitoring and control strategies to prevent unexpected failures.

INTRODUCTION

The ALBA Synchrotron Light Source cooling system presents a common return pipe that interconnects the four consumption rings as outlined in Fig. 1. This design configuration introduces complexity to the system behaviour because strong interdependency among them exists.

As clearly exposed by Swetin [1], it is imperative that water flow and temperature are both maintained with a high degree of reliability because most accelerator components are interlocked. In particular, it is necessary to understand the system behaviour when facing typical piping problems like blockages or leakages to prevent failures. Moreover, the capacity of the system to respond against temporary changes in the required thermal loads must be checked out.

The motivation of such knowledge is to develop and apply correct monitoring and maintenance strategies to optimise system operation and reliability. It is also necessary in order to allow upgrades that improve reliability and integrate new operating parameters.

Consequently, a numerical simulation appears as an economic and reliable procedure if a preliminary adjustment is carried out to guarantee the accuracy. For that purpose, the Flowmaster[®] software has been chosen because it has been successfully used to simulate complex fluid networks and advanced control systems as demonstrated in the work of Sprengel [2].

NUMERICAL MODEL

A complete model of the generation side of the cooling system has been built up with typical elements such as pipes, junctions, bends, transitions and valves. More particular elements are the pumps, the heat exchangers, the storage tank and the expansion tank. The consumption side, comprising the four rings, has been simplified due to its complexity to a heat exchanger component with the corresponding total heat duty. The properties of each component have been defined from information provided by the manufacturer as well as from data obtained by visual inspections and measurements in-situ. Details and images of the current model can be found in [3].

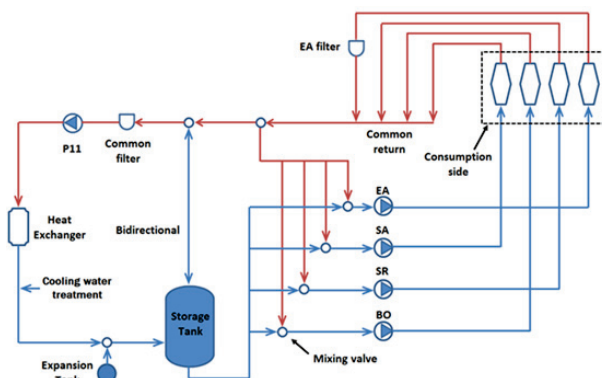

Figure 1: Outline of the ALBA cooling system.

The main regulation systems which correspond to the three-way valves (V3V's) for mixed water temperature at 23 °C, the heat exchangers (EX07) for cooling at 21 °C and the pump engine frequency converters for limiting the delivery pressures have been modelled with PID elements. The four pumping stations have been named P07, P08, P09 and P10 for the Experimental Area (EA), the Storage (SR), the Booster (BO) and the Service Area (SA) consumption rings, respectively.

In order to certify the accuracy of the model, the simulated results under steady state conditions were compared with on-site measured data indicated in Table 1. The hydraulic variables showed maximum deviations around 6 % and the thermal variables around 13%.

* escaler@mf.upc.edu

† jcasas@cells.es

‡ ccolldelram@cells.es

§ mquispe@cell.es

mprieto@cells.es

Table 1: Nominal Delivery Pressures, Flow Rates, Outlet Temperatures and Head Duties

Ring	P [bar]	Q [m ³ /h]	To [°C]	\dot{Q} [W]
BO	10.2	28.5	23.6	16559
SR	11.0	271.1	25.6	684116
SA	10.2	200.2	25.3	486354
EA	7.5	16.2	22.2	3752

SIMULATED RESPONSE

Thermal Load Shut-down

The outlet temperature of the SR has been reduced from its nominal level of 25.6 °C until 23.4 °C as if no heat duty demand existed. The evolution of the V3V's water temperatures takes 540 s to stabilize as observed in Fig. 2.

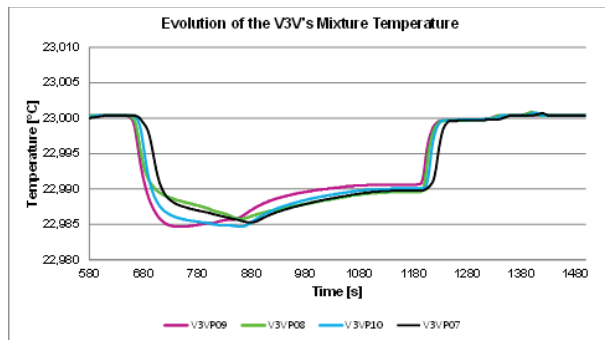

Figure 2: Temperature evolution due to the SR's thermal load shut-down.

Initially, the outlet temperature reduction takes around 80 s to affect progressively the mixed flow temperatures from the closest pumping station until the furthest one to the common return pipe. The regulation system reacts reducing the cold flow from the tank and simultaneously increasing the hotter flow from the common return. At the same time, the increased demand of water from the common return by the V3V's provokes a reduction of the suction flow rate of the pumping station P11. Such reduction is automatically compensated by an equivalent increase of flow from the storage tank to the P11 suction pipe through the bidirectional connection. As shown in Fig. 3, all the pumping stations suffer a reduction of the suction pressure.

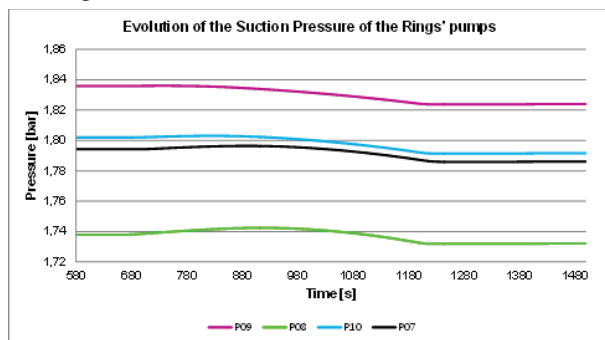

Figure 3: Pumps' suction pressures evolution during the SR's thermal load shut-down.

Thermal Load Start-up

The SR's outlet temperature has been increased progressively during 540 s from 23.4 °C at around 600 s to 25.5 °C. This transient is initially felt at around 680 s by the V3V's. As a response, the suction of cold water from the tank is increased and the one from the return flow is decreased. Consequently, the common return flow rate increases again and the flow through the bidirectional line is reduced. Regarding the suction pressures, initially they increase again but later on they show a slight decrease. At the end of the process, all of the pumping stations' suction pressures have increased significantly as shown in Fig. 4.

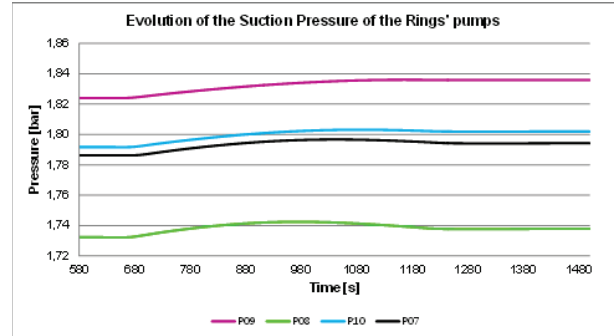

Figure 4: Pumps' suction pressures evolution during the SR's thermal load start-up.

Pipe Blockage

At constant heat duty, the SR valve has been progressively closed and thus provoking a flow rate reduction from its nominal value of 271.1 m³/h until a 20 % reduction in approximately 190 s. As shown in Fig. 5, this procedure has been forced with two different closure laws, first fast and second slow, owing to the fact that the flow rate is not significantly reduced until the valve ratio is below 0.2.

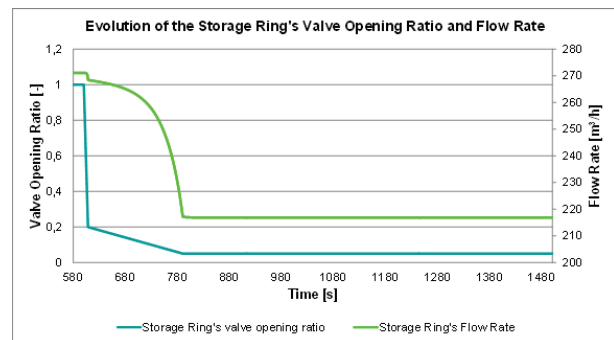

Figure 5: Evolution of the closure of the SR's outlet valve and of the resulting flow rate reduction.

The initial change of valve position provokes an immediate effect on the hydraulic parameters but the system thermal response is delayed because the consequent increase of the SR's outlet temperature takes 80 s to reach the V3V's.

Regarding the hydraulic response, a significant increase of the P08 suction pressure is provoked that is also observed in the rest of pumps but with lower amplitudes as shown in Fig. 6. Simultaneously, the temperature of the

Content from this work may be used under the terms of the CC BY 3.0 licence (© 2016). Any distribution of this work must maintain attribution to the author(s), title of the work, publisher, and DOI.

mixed flow decreases because less flow arrives from the common return. As a result, the regulation starts to close the tank flow at the V3V's. At the same time, the flow from the tank towards P11 also increases to compensate the flow rate reduction at the common return pipe.

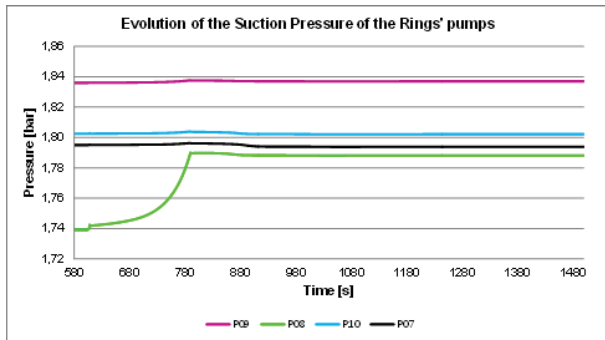

Figure 6: Pumps' suction pressures evolution during the SR's pipe blockage.

Due to the delayed thermal response, the pump suction pressures and the flow rate at the bidirectional connection decrease slightly, although they stabilize with a higher level than the initial one. Therefore, only the P08's suction pressure has increased significantly than the rest at the end.

Pipe Leakage

A leakage at the inlet of the SR that increases steadily during 400 s to reach a continuous flow rate loss of 0.8 m³/h has been forced. Previous simulations have been carried out to determine the minimum leakage that decreases the return pressure until 1.6 bar which is the minimum admissible return pressure.

In general terms, the suction pressures at the pumping stations also decrease provoking an increase of the pumps' rotational speed as well as the rings' flowrate as shown in Fig. 7. It is observed that the P08 supplies the leaked flow which is almost entirely provided by the expansion tank. The remainder as well as the increase of the ring's flowrate is supplied by the storage tank through the mixing valves.

In addition, the ascending flow rate through the bidirectional connection decreases to compensate the increase of the ring's flow rate, which does not provoke any significant thermal transient.

Finally, when the return's pressure reaches the value of 1.6 bar the expansion tank is unable to supply the leakage flow. At this point, an external pump (P21) would start injecting water stored in an emergency reservoir.

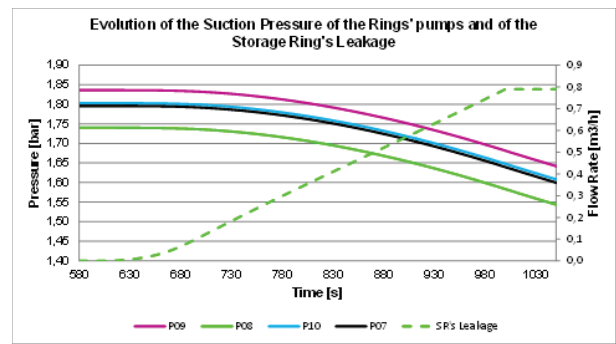

Figure 7: Pumps' suction pressures evolution during the SR's pipe leakage.

CONCLUSION

An accurate 1D model of the ALBA Synchrotron Light Source cooling system has been built that permits to evaluate the response to hydraulic or thermal transients.

The system response to a thermal load shut-down and start-up, to a ring blockage and to a ring leakage have been simulated and investigated in the SR. It has been predicted that the hydraulic transients propagate immediately through the entire network. Meanwhile, the thermal transients travel with the flow and they require a certain time to reach other zones. The common return design enhances the interaction between rings so that the transients affecting large flow rates propagate their effects to the rest of rings.

The current results indicate that thermal stability is guaranteed during thermal start-up and shut down. For hydraulic stability, it is required that the expansion tank copes with the pressure fluctuations provoked by the transients. The existence of a flow blockage or leakage at any ring can be identified from the behaviour of the pumps' suction pressure. Therefore, their monitoring and control should be used for detection and prevention of unexpected operating changes or failures in the pipes.

ACKNOWLEDGEMENT

The authors would like to acknowledge the support of the ALBA Cooling System Upgrade Team.

REFERENCES

- [1] E. Swetin, M. Kirshenbaum, and C. Putnam, "Cooling Water Systems for Accelerator Components at the Advanced Photon Source", in *Proc. 2nd International Workshop on Mechanical Engineering Design of Synchrotron Radiation Equipment and Instrumentation (MEDSI02)*, Argonne, Illinois, USA, 2002.
- [2] J. Sprengel, "Flowmaster for Dynamic Water Network Simulations Down Under", *Engineering Edge*, vol. 3, no. 2, pp. 36-39, 2014, <http://s3.mentor.com/mechanical/engineering-edge/vol3-issue2/volume3-issue2.pdf>
- [3] M. Quispe *et al.*, "ALBA cooling system upgrade: thermal hydraulic numerical simulations", in *Proc. MEDSI 2014 Conference*, Melbourne, Australia, October 2014, pp. 1-14.