

## REALISTIC DESIGN OF DETUNED STRUCTURE FOR JLC

M. Yamamoto\*<sup>1</sup>, T. Taniuchi\*<sup>2</sup>, K. Kubo, T. Higo and K. Takata

\*<sup>1</sup>The Graduate University for Advanced Studies

\*<sup>2</sup>Laboratory of Nuclear Science, Tohoku University  
KEK, National Laboratory for High Energy Physics  
1-1 Oho, Tsukuba-shi, Ibaraki-ken, 305, Japan

### Abstract

The long range transverse wake field must be damped by two order of magnitude at the next bunch in a multi bunch operation for Japan Linear Collider(JLC). The wake field in a detuned structure was investigated by an equivalent circuit model. It was found from this calculation that the wake field can be damped by two order of magnitude in a structure over a train of 20 bunches. If several structures with slightly different frequencies are taken into account, the wake field can be damped by two order of magnitude in a train of even a hundred bunches.

### Introduction

To achieve a luminosity of a few times  $10^{34}$  cm<sup>-2</sup>sec<sup>-1</sup> in TeV region, a multi bunch operation of a few tens bunches with a bunch spacing of 1.4 nsec is planning in the JLC[1]. In this operation, the emittance growth due to the long range transverse wake field in an X-band main linac becomes a serious problem. To suppress this growth, the long range transverse wake field must be damped by two order of magnitude at the next bunch compared with the amount excited by the preceding bunch. There are two kinds of possible structures for suppressing the wake field. One of them is called damped structure[2], where the wake field is extracted from the structure before the next bunch arrival by connecting wave guides to outer wall of a cell. Another is called detuned structure[3], where the wake field can be cancelled by spreading the frequency of the relevant mode of each cell in a structure. The later structure is the theme of this paper.

The detuned structure consists of a hundred of accelerating cells. The dimension of a cell differs slightly from those of the adjacent cell. It is difficult to calculate the wake field of this type of structure by such a code as TBCI[4], due to the limitation of the mesh and the CPU time. On the other hand, the coupling from cell to cell is not so large and a coupled resonator model can be a good approximation to this system. For example such models have been used to date as a single chain circuit without coupling[3,5], a single chain of coupled circuit[6,7,8] and a double chain of coupled circuit[7].

The mode that causes the largest long rang transverse wake field is the lowest dipole mode [10]. An analysis based on a single chain of coupled circuit gives us a fairly good estimation[6,7,8]. However, the detailed analysis should be performed including the coupling or mixing of second dipole mode[9]. In this paper, the lowest two dipole modes were described by a double chain of coupled circuit. Based on this

model, some design considerations were studied and discussed in this paper.

### Equivalent circuit model

As mentioned in the introduction, the severest transverse wake field is the lowest dipole mode in which TM110-like field and TE111-like are mixed. It is a good approximation to express this characteristics of the mode as the mixing of the two kinds of modes and to describe by the double chain of coupled circuit model[7]. This circuit model and its equation are shown in Fig.1 and the following equation[7], respectively.

$$([M]\omega^2 + [C]\omega + [K])\{x\} = \{0\}$$

In this equation, the matrices  $[M]$ ,  $[C]$ ,  $[K]$  are evaluated from the coupling between cells, the Q value and the resonant frequency without coupling, where these parameters were calculated by using URMEL[10]. On the other hand, the eigen value  $\omega$  and the eigen vector  $\{x\}$  that express the current in the circuit correspond to the resonant frequency and the intensity of the field of a mode, respectively.

The wake field was calculated from the eigen vector and the eigen value as follows. First, the loss parameter of the mode was calculated by integrating the field in a cell calculated by URMEL and being multiplied by the corresponding component of the eigen vector. Then the wake field can be calculated by superposing the loss parameter multiplied by a factor  $\sin(\omega t)$ . This formalization will be described in detail[11].

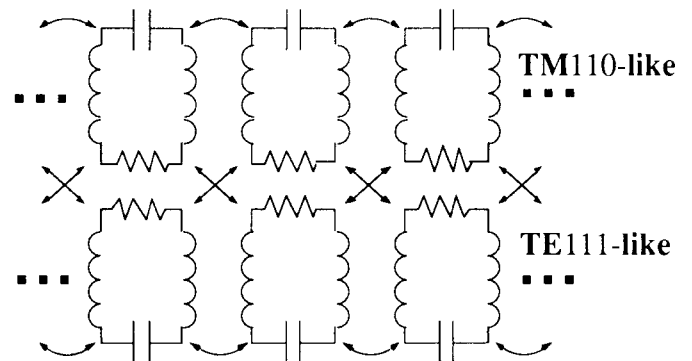

Fig.1 Double chain of coupled circuit .

### Results

In the following, the results for various detuned structures were described. The Q value is fixed to that of the

$\pi$ -mode which makes the analysis almost lossless. The frequency distribution was made by changing only the beam hole radius and the disk thickness was fixed.

Frequency distribution

The damping pattern of the wake field can be roughly estimated from Fourier transform of the frequency distribution in the structure[12]. In order to damp the wake field below 1% at the next bunch, the standard deviation  $\sigma$  of the Gaussian distribution should be larger than 0.35 GHz.

The distribution of a real structure will be truncated Gaussian instead of the Gaussian due to a finite number of the cells. To optimize the parameter of truncated Gaussian distribution with 150 cells, the wake field was calculated as a function of the full width  $\Delta f$  and standard deviation  $\sigma$ . An effective beam hole radius for short range wake field ( in proportion to  $a^{-3.5}$  ) is set  $0.16\lambda$ , where the center frequency becomes 15.6 GHz.

Maximum wake field from next bunch to 20th bunch was calculated and shown in Fig.2. If the full width is larger than 1.5 GHz, the wake field can be damped below 1%. In this case, the  $\sigma$  does not contribute much. Smaller  $\sigma$  makes the distribution closer to Gaussian. However  $\sigma$  should be larger than 0.35 GHz as stated above. From these consideration,  $\sigma$  of 0.35 GHz and  $\Delta f$  of 1.7 GHz were chosen as a proper parameter in this paper. The wake field in this parameter is shown in Fig.3.

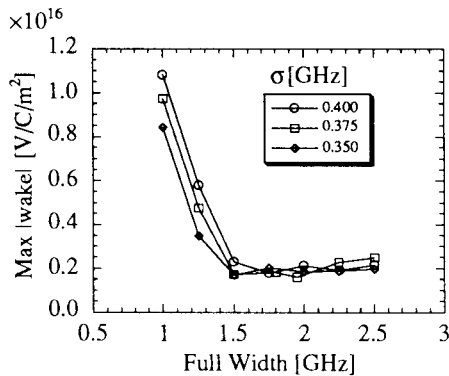

Fig. 2 Maximum wake field between second and 20th bunch versus the parameters of frequency distribution.

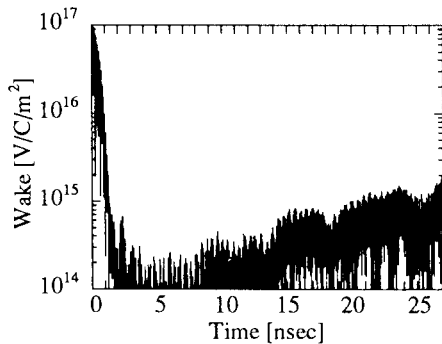

Fig.3 Wake field with  $\sigma=3.5$  GHz and  $\Delta f=1.7$  GHz.

Coupler cells

Since the coupler cells has a RF feed ports, its higher order mode frequency and Q value are different from those of the normal cell. If we assume a double feed coupler cell, the

lowest dipole mode frequency which does not couple to those feeds will be about 5 percent higher than normal cell. Fig. 4 shows the poor cancellation of the wake field during several nano second, though still keeping less than 1% level, meaning no severe effect but only about 2/number of cells. On the other hand, the frequency of the mode which couples to RF feed port might be very close to that of the normal cell. However, in this case the extracted field can be reflected back at some reflection coefficient. This effect on wake field was found small since little change of the wake field was observed when the boundary condition of the end cell was changed from electric short to magnetic short.

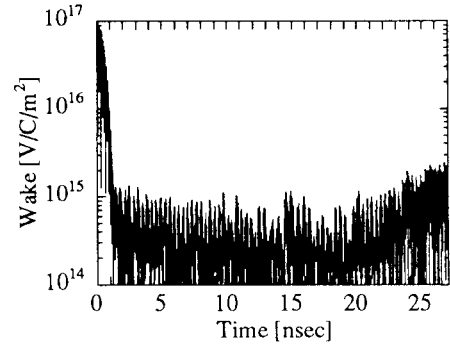

Fig. 4 Wake field in a structure with coupler cell's frequency 5% higher.

Fabrication error

The deterioration of the damping due to the fabrication error of each cell frequency was evaluated assuming the error distribution to be Gaussian with its standard deviation  $\sigma$  and truncated at  $\pm 3\sigma$ . The damping below 1% can be achieved if  $\sigma$  is less than  $1 \times 10^{-4}$ . Since the present target precision of frequency for manufacturing an X-band structure for JLC is  $\pm$  a few times  $10^{-5}$ , the requirement of damping below 1% is satisfied as shown in Fig.5.

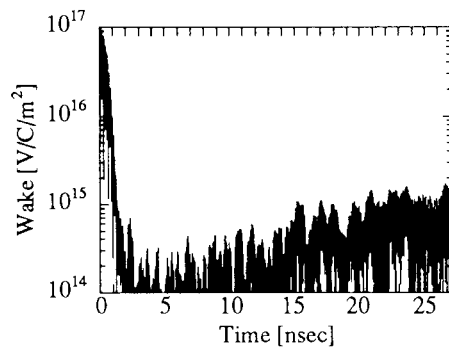

Fig. 5. Wake field in the structure with fabrication error with its standard deviation  $\sigma$  and truncated at  $\pm 3\sigma$ .

Combination of structure

A multi bunch operation of a hundred bunches in a train became recently one of possible parameter of JLC[1]. It is difficult to damp the wake field below 1% over such a bunch train by a single detuned structure as shown in Fig. 6 which shows the later part of Fig. 3. It is because the wake field is recovered at the time which is roughly inverse of the frequency spacing with large loss factors. If the same

frequency distribution can be made with larger number of cells, the recurrence time will be longer. It seems possible to make the effective number of cells in a structure constant by simply incorporating several independent structures with the same frequency distribution but slightly different mean frequencies. Actually, the wake field can be damped over the long train by four structures as shown in Fig. 7.

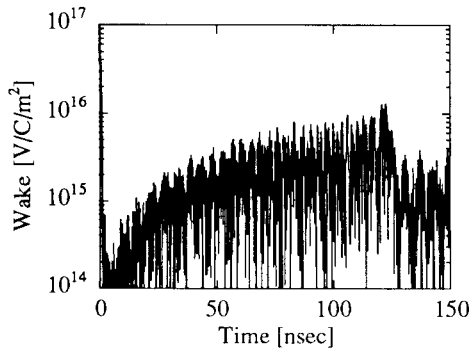

Fig. 6 Wake field by one detuned structure.

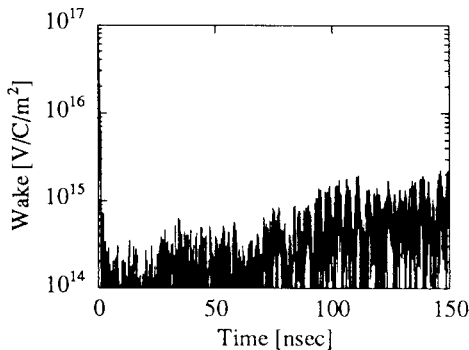

Fig. 7 Wake field by four structures.

### Accelerating field

The accelerating field was calculated in the detuned structure treated in previous section. To make a Gaussian distribution of standard deviation of 0.35 GHz and full width of 1.7 GHz in a structure, the beam hole radius is changed from 5.1 mm at the input cell to 3.2 mm at the output cell. In this situation, the accelerating field was shown in Fig. 8. The accelerating field changes rapidly near input and output region.

The filling time and the attenuation parameter are 125 nsec and 0.69, respectively. Then the required power for accelerating gradient of 100 MV/m without beam loading is 213 MW.

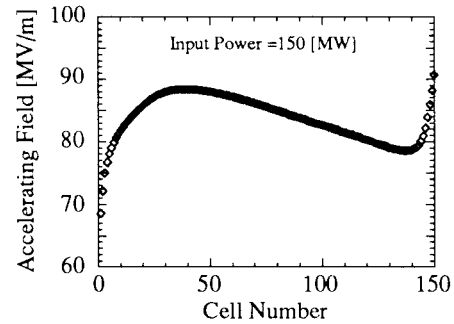

Fig. 8 Accelerating field of a detuned structure

### Conclusion

The wake field can be damped by two order of magnitude over 20 bunches in a detuned structure with a proper frequency distribution. The wake field can be damped by two order of magnitude over a hundred bunches by incorporating several such structures.

### Reference

- [1] K. Takata, KEK preprint 92-70, July 1992.
- [2] R. B. Palmer, SLAC-PUB-4542, 1989.
- [3] H. Deruyter et al., Proc. of the 1990 Linear Accelerator Conference, Albuquerque, 1990.
- [4] T. Weiland, Nucl. Instrum. Methods 212(1983), 13.
- [5] T. Higo et al., X-band Accelerating Structure for Japan Linear Collider, KEK Preprint 91-32, 1991.
- [6] K. L. F. Bane et al., THE COUPLED DIPOLE MODES OF THE NLC ACCELERATOR STRUCTURE, SLAC-PUB-5766 March 1992.
- [7] Karl L.F. Bane, THE TRANSVERSE WAKE FIELD OF A DETUNED X-BAND ACCELERATOR STRUCTURE, SLAC-PUB-5783 MARCH 1992.
- [8] M. Yamamoto et al., KEK preprint 91-153, Nov. 1991.
- [9] T. Higo et al., Proc. of the 1990 Linear Accelerator Conference, Albuquerque, 1990.
- [10] T. Weiland, Nucl. Instrum. Methods 216(1983), 329.
- [11] To be published.
- [12] K. A. Thompson et al, Proc of the 1990 Linear Accelerator Conference. San Francisco, 1991 P.431.