

THE RF-SYSTEM FOR A HIGH CURRENT RFQ AT IHEP

Zhang Zonghua, Qiao Jimin, Li Jian, Xu Xinan,
IHEP, Institute of High Energy Physics, Beijing100039, China

Abstract

The R&D of a high current proton RFQ is one of the most important research tasks of the Accelerator Driven Sub-critical system (ADS) basic research project. In preliminary research phase, the 352.2MHz RF system will be operated in pulse mode. CERN kindly provided IHEP with some RF equipment. Because the given RF system was used for CW operation at CERN before, to apply them to our pulse mode operation, some modifications and improvements are necessary. We have made some indispensable assemblies, and also did some tests and commissioning of every sub-system. At present, the initial high power conditioning of the klystron is carried out. A description of RF power system is given, in particularly, the performance of HV power supply, thyatron crowbar and capacitors, hard tube modulator and its control electronics, and klystron power conditioning are presented.

INTRODUCTION

The programme of building our RF power system, in brief, includes two phases--the 1st phase is to modify CERN LEP / RF equipment and to install a RF power test stand of our own for pulse mode operation. That is, klystron amplifier is directly connected to dummy load and meanwhile, R&D of long pulse hard tube modulator for klystron TH2089 is carried out. The 2nd Phase is fabrication of RF power transmission and distribution system from the klystron amplifier to the RFQ cavity; at last, we will perform RFQ power delivering and conditioning. Design features and parameters of RF system are shown in Table 1. The picture of RF power test stand can be seen in Fig. 1.

Table 1: Design features and parameters

Frequency	352.209MHz
Pulsed output RF power	1 MW max.
Waveguide system	WR2300
Klystron cathode voltage	95 kV max.
Klystron modulation anode voltage	62 kV to 0



Figure 1: Panorama picture of our RF power test stand.

HV POWER SUPPLY

General Layout

The power supply of a klystron is a 100kV, 20A power converter. It consists of four basic units: step-down transformers TR1 and TR2 (10 / 1 kV), a thyristor AC line controller and its electronics, high voltage transformers TR3 and TR4 (1 / 52 kV), diode rectifier and the filter chokes unit.

Step-down Transformers

Original HV power supply at CERN was fed from the 18 kV, 50 Hz, three-phase mains, but in China the mains feeding voltage is 10kV, therefore we specially redesigned and manufactured the step-down transformer unit in China to match CERN LEP power supply equipment. The primaries of the two step-down transformers TR1 and TR2 are fed from the 10kV, 50Hz, three-phase mains. The secondary output voltage of each transformer is 1kV line-to-line. The two transformer units are housed in one tank and are immersed in mineral oil. They are air natural / oil natural cooled. The winding configuration of the two step-down transformers is extended delta / star, so their secondaries can form phase-shift of 30 degrees between TR1 and TR2. A twelve-phase system at the HV DC output terminals is obtained. This can help to reduce the DC output ripple. The ripple of the whole power supply is no more than 1%.

Vector group of TR1 is dyn 11.5, and TR2's is dyn 0.5. That means, the phase-shift of the TR1 secondary voltage with respect to the feeding mains is +15 degrees, and the TR2's is -15 degrees. Thus, the required phase-shift of 30 degrees between TR1 and TR2 is obtained. The two transformers are designed symmetrically. It can limit the difference between the two halves of the converter and minimize sub-harmonic generation. Under the acceptance test, the phase-shift between TR1 and TR2 is 30.03 degrees. The design allowable tolerance of phase shift is 30 ± 0.1 degrees. So the result of the acceptance test is satisfying.

Thyristor AC Line Controller

The power converter can provide 0 to 100kV continuously variable output voltage. This is realized by controlling firing angle of the thyristors of the thyristor AC line controller. The different firing angle corresponds to the different current in each branch of the thyristors. The input voltage of the thyristor AC line controller is fixed at 1kV, and the output voltage can be adjusted from

0 to 1kV, then, it is fed into the diode rectifier. Input and output voltage waveforms of one module of thyristor AC line controller are given in Fig. 2.

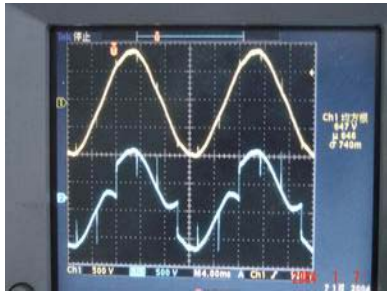

Figure 2: Input and output voltage of thyristor AC line controller.

THYRATRON CROWBAR AND CAPACITORS

In pulse mode operation, capacitor bank is necessary for energy storage. The thyatron crowbar is a klystron protection device. Since the above mentioned components are immersed in oil, they must be housed in a fireproof bunker. In the case of an arc occurring inside the klystron, the thyatron crowbar can remove the high voltage energy from the klystron within a few microseconds in order to avoid the damage of the klystron. At the same time, the thyristor AC line controller is phased back safely to bring the DC output voltage of the rectifier to zero. So the fault is cleared immediately.

The thyatron crowbar comprises the eight-gap double-ended thyatron CX2098B, made by EEV, and its electronic trigger circuit. Since the operating voltage of klystron is no more than 100 kV, the maximum voltage across each gap is thus 12.5 kV which is half specified value and, therefore, voltage breakdowns should not occur or if so very rarely [1]. We used four capacitors (2uF) for energy storage. A wideband current transformer is inserted in the low voltage line of each capacitor. The output signals of the four current transformers are connected in parallel into interlock interface electronics, then, passing on a summary fault signal to the thyristor AC line controller for turn off the HV power converter in case of internal flashover in klystron. In a simulation fault protection test, we fed a 2us-pulse trigger signal as substitute of overcurrent signal into interlock interface electronics, an output control signal can go to thyristor AC line controller within 4 us (see Fig. 3).

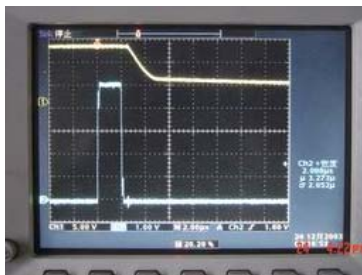

Figure 3: Simulated overcurrent input signal and output control signal of the interlock interface electronics.

HARD TUBE MODULATOR AND ITS CONTROL ELECTRONICS

The schematic diagram of the modulator is shown in Fig. 4. The klystron TH2089 is equipped with a modulation anode (MA). The MA voltage with respect to the cathode determines the intensity of the electron beam current departing from the cathode. By varying the MA voltage, the klystron beam current can be controlled, and hence klystron output power can be controlled while keeping RF drive level and operating voltage constant. Because ADS RFQ operates in pulse mode, emphasis of ADS RF system research is laid on the long pulse modulator, which can change duty factor and amplitude of the klystron output power. The modulator's parameters are:

- Output pulse width: up to 3ms.
- Duty factor: 1% ~ 10%, continuously adjustable.
- Output peak voltage with respect to the cathode: $\leq 62KV$.

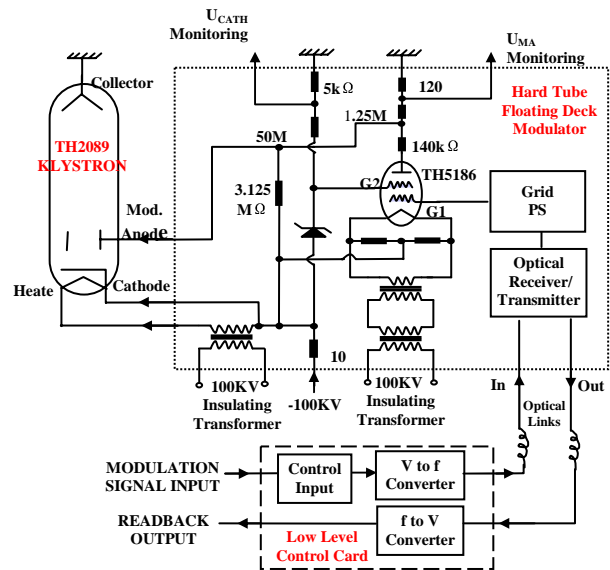

Figure 4: Schematic diagram of hard tube modulator.

The modulator is the type of the hard tube floating deck modulator. It mainly comprises the HV resistors, the HV tetrode TH5186 and its control electronics. The tetrode is suited for 100kV operation voltage, made by Thomson Company. The function of the tube is that of a variable high voltage resistor. The tube together with the HV resistors 1.25 M Ohms and 3.125 M Ohms form an adjustable resistive voltage divider, which determines the maximum and minimum MA voltage.

Because the tetrode is at cathode potential, all control signals must be insulated. For this reason, the optical fibers, the low level control card and the control electronics of the tetrode grid are employed. The low level control card is developed for converting a voltage signal to a frequency signal that passes on via optical fiber, and vice versa. A signal derived from the low level control card, the frequency of which is proportional to the voltage value of a modulation control signal, is sent via

the optical fiber to the control electronics of the tetrode grid. Through conversion by the control electronics, the tetrode grid obtains variable biasing supply (V_{G1}) (see Fig. 5). Thus, the tube represents either infinite or a very small resistance value compared to those of the HV resistors (1.25 M Ohms and 3.125 M Ohms). By means of the variable grid supply, the internal impedance of the tube can be varied between the above mentioned two extremes. The test voltage waveforms of a modulation control signal and the tetrode grid voltage (V_{G1}) are given in Fig. 6.

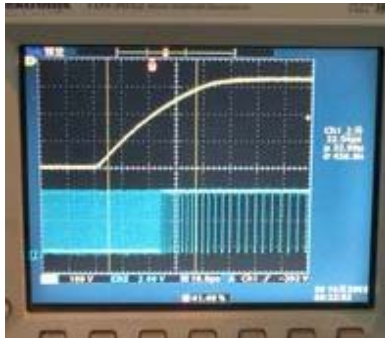

Figure 5: V_{G1} and frequency signal from the voltage to frequency converter.

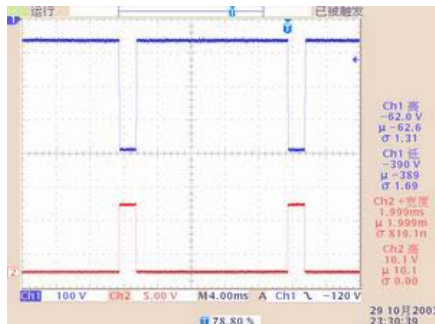

Figure 6: V_{G1} and the modulation control signal of low level control card.

Besides the HV resistors, the HV tetrode TH5186 and its control electronics, two 100kV insulating transformers and a 10-Ohms carbon-ceramic resistor are also housed in the modulator oil tank. One of the insulating transformers provides the operating voltage for the cathode heater of the klystron; the other one supplies the voltage for the heater and the grid control electronics of the tetrode. The 10-Ohms carbon-ceramic resistor is inserted in the high voltage line in series to the klystron and serves as an energy limiter in the case of an arc in the klystron.

KLYSTRON POWER CONDITIONING

Because the klystron given by CERN was a used and ever repaired tube, which stopped and stored up for four years, we must recondition it again. However, due to high

storage energy of capacitor bank, only one capacitor instead of four is connected in parallel into HV power supply for the first step of power conditioning in order to protect klystron. At present, the initial high power conditioning of the klystron is carried out, and output power can reach up to 334 kW at 62 kV in CW mode and 402 kW at 66.5 kV in pulse mode. Waveforms of RF power, klystron beam current and cathode voltage are shown in Fig. 7 and Fig. 8. Next step, it will take us long time to raise conditioning power to reach nominal value. And at last, all of four capacitors will be used, and high RF power will be applied to RFQ cavity.

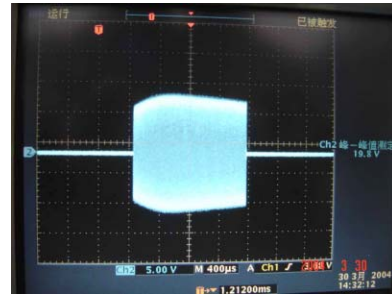

Figure 7: RF power waveform.

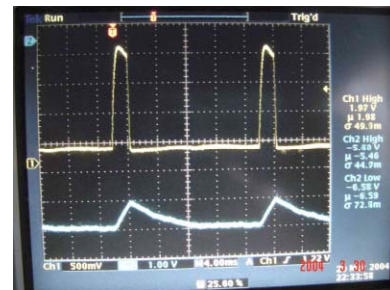

Figure 8: klystron beam current and cathode voltage.

ACKNOWLEDGEMENTS

The authors would like to thank Prof. Kurt Hubner and Dr. John Poole for their great support about CERN-IHEP collaboration and LEP / RF equipment that was presented to IHEP and also Dr. Tom Wegelius who was charge of LEP / RF equipment transportation from CERN side. Especially, we are also grateful to Dr. Hans Frischholz for his kind help and doing a lot of jobs for us. Thanks are also due to Prof. Fu Shinian and Prof. Guan Xialing for their great support and contribution on RF system.

REFERENCES

- [1] H. Frischholz, G. Pecheur, "The High-voltage Interface for the LEP II RF Power Generation System", 4th European Particle Accelerator Conference, London, UK, 27 Jun - 1 Jul 1994, p. 1939-1941.