

SIMULATION OF QUENCH DETECTION ALGORITHMS FOR HELMHOLTZ ZENTRUM BERLIN SRF CAVITIES*

P. Echevarria[†], A. Neumann, A. Ushakov, Helmholtz Zentrum Berlin, Berlin, Germany
B. Garcia Arruabarrena, J. Jugo, University of the Basque Country (UPV/EHU), Leioa, Spain

Abstract

The Helmholtz Zentrum Berlin is carrying out two accelerator projects which make use of high gradient Continuous Wave (CW) SRF cavities: bERLinPro and BESSY-VSR. In both projects, a prompt detection of a quench is crucial to avoid damages in the cryomodules and cavities themselves. In this paper, the response of real time estimation of the cavity parameters using the transmitted and forward RF signals is simulated, in order to perform the quench detection. The time response of the estimated half bandwidth is compared with the dissipated energy in the cavity walls for the different type of SRF cavities used in both projects, i.e., bERLinPro's photoinjector, booster and linac, and BESSY-VSR 1.5 GHz and 1.75 GHz cavities. As an intermediate step prior to the implementation in an mTCA.4 system together with the LLRF control and test with a real cavity, the algorithm has been implemented using a National Instruments FPGA board to check its proper behavior.

INTRODUCTION

Continuous Wave (CW) high gradient operation of SRF cavities is a shared characteristic of the two projects currently in implementation phase at Helmholtz Zentrum Berlin (HZB): BESSY-VSR [1] and bERLinPro [2]. The former project consists of introducing SRF cavities at 1.5 and 1.75 GHz in the storage ring of the BESSY-II synchrotron light source to allow short and long pulses at the same time. The latter is a demonstration facility for the science and technology of ERLs for future light source applications.

During a quench the quality factor of the cavity Q_0 will decay from the superconducting value (in the order of 10^{10}) to the normal conducting one (10^4) causing a change in the loaded quality factor, $Q_L = \left(\frac{1}{Q_0} + \frac{1}{Q_e}\right)^{-1}$, where Q_e is the external quality factor whose values depend on the application. Two types of quenches can be considered: hard and soft quenches [3]. In the former the full cavity becomes normal conducting while in the latter only portions of the cavity turn normal conducting. As the heat load increases, this portion expands until the full cavity quenches. In CW operation, unlike in pulsed operation, Q_L cannot be calculated using the pulse decay for hard quenches detection and there is no time without RF where a soft quench can be partially recovered. Thus, when a quench occurs the dissipated power in the walls dramatically increases reaching

the limit of heat transport capacity of the helium system. In this situation, it is of paramount importance to have a CW quench detection procedure integrated in the Machine Protection System (MPS) [4]. It is important to remark that $\omega_{1/2}$ only changes significantly when Q_0 gets comparable with Q_e inducing thus a change in Q_L and that the lower the Q_e , the later the quench will be observable.

The real time cavity parameters' estimation using the transmitted and forward signals can be implemented in the Low Level RF (LLRF) control hardware [5]. In this paper the simulation of such real time estimation algorithm is presented for the SRF cavities of both HZB's projects, whose main parameters are shown in Table 1 (a $Q_0=5 \cdot 10^9$ was assumed for all cavities), and the results are compared with the dissipated energy in the cavity walls.

Table 1: HZB's SRF Cavities' Parameters: Loaded Quality Factor, Half-Bandwidth, Normalized Shunt Impedance, Frequency And Accelerating Field

Cavity	Q_L	$\omega_{1/2}$ (rad/s)	r/Q (Ω)	f_0 (GHz)	E_{acc} (MV/m)
Gun	$3 \cdot 10^6$	$1.36 \cdot 10^3$	150	1.3	12
Booster	$1.74 \cdot 10^6$	$2.35 \cdot 10^3$	220	1.3	10
Linac	$5 \cdot 10^7$	81.7	770	1.3	20
VSR1.5	$5 \cdot 10^7$	94.2	490	1.5	20
VSR1.75	$5 \cdot 10^7$	110	490	1.75	20

ALGORITHM AND IMPLEMENTATION

As shown in [6] the detuning ($\Delta\omega$) and half-bandwidth ($\omega_{1/2}$) parameters of the SRF cavities in the absence of beam, can be obtained using the following equations:

$$\omega_{1/2} = \frac{I_c(2KI_f - \frac{dI_c}{dt})}{I_c^2 + Q_c^2} + \frac{Q_c(2KQ_f - \frac{dQ_c}{dt})}{I_c^2 + Q_c^2} \quad (1)$$

$$\Delta\omega = \frac{I_c(\frac{dQ_c}{dt} - 2KQ_f)}{I_c^2 + Q_c^2} + \frac{Q_c(2KI_f - \frac{dI_c}{dt})}{I_c^2 + Q_c^2} \quad (2)$$

where I_c , Q_c , I_f and Q_f are respectively the in-phase and in-quadrature components of the cavity voltage measured with a pick-up antenna and the forward voltage coming from the RF amplifier (Solid State Amplifier or Klystron). K is a constant given by cavity parameters and the factors of attenuation produced by sensors, coaxial cables, and ADC conversion which relate the physical RF wave magnitudes and the numerical values used inside the FPGA and is quantified by $K = \frac{\omega_0 r}{2} \frac{att_f}{att_c}$, where att_f and att_c are the relation between the physical magnitudes of the measured RF signals and the numeric fixed point values used to represent them.

* Work supported by German Bundesministerium für Bildung und Forschung, Land Berlin, grants of Helmholtz Association and partially supported by Basque Country PPG17/25 project.

[†] pablo.echevarria@helmholtz-berlin.de

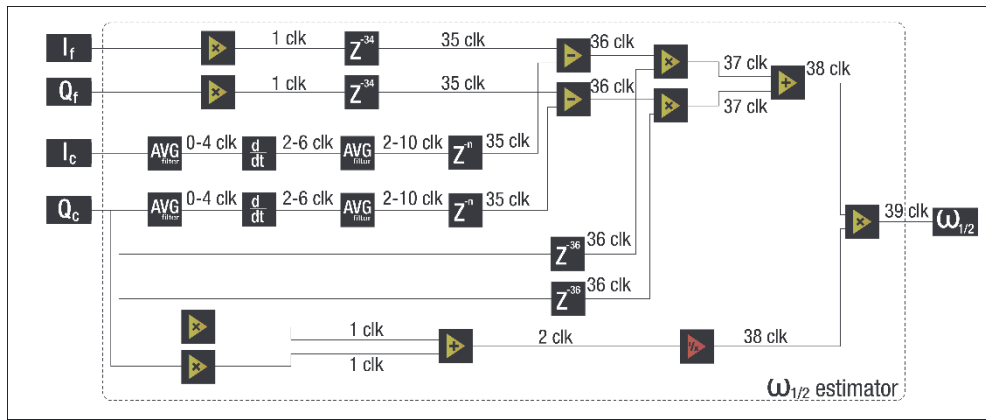

Figure 1: $\omega_{1/2}$ estimator block diagram with the clock delays of each block.

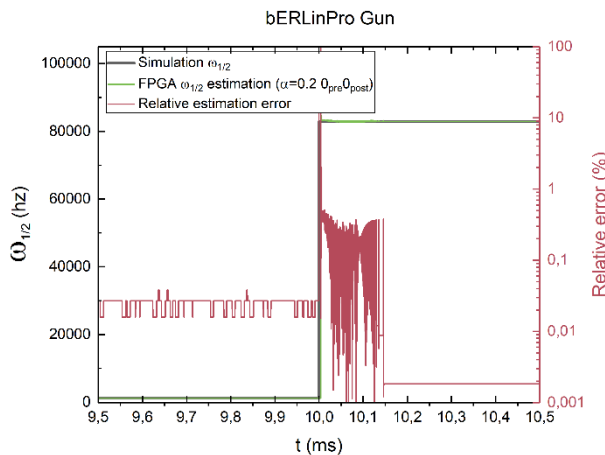

Figure 2: $\omega_{1/2}$ estimation of the bERLinPro's gun cavity compared with the simulation for a hard quench at 10 ms.

The schematic of the $\omega_{1/2}$ estimator implementation is illustrated in Fig. 1. Also, the latency that each arithmetic block introduces into the parameter estimation is shown. The $\Delta\omega$ estimator is implemented using a similar structure onto the same FPGA in parallel, although its results are not shown in this paper.

Due to design constraints, the input I_c , Q_c , I_f and Q_f signals are quantized using signed 18 bit representations. As a consequence of quantization noise, derivatives become substantial noise sources. Therefore, filters are used before, during, and after the derivatives. Programmable average filters are used before and after the derivative. These can calculate the average value of the last 0 (pass-by mode), 4, 8 or 16 values depending on how much filtering the signals need. Since we expect that it will be necessary in some extreme cases, we do not use a strict derivative. Instead of it, we use an approximation of a derivative, which is obtained adding a pole to the strict one. This way, approximated derivative can be tuned depending of certain needs using the value of α , which fixes how far the added pole is from the origin, and so, how aggressive the filter is. With $\alpha = 0$ the approximation will be a perfect derivative, while approximations with $\alpha \rightarrow 1$ will give smoother solutions. The designed implementation is pipelined and it calculates every output with a delay of 39 clocks.

As a first step, before integrating this calculation into the current LLRF system, the algorithm has been implemented in a Kintex-7 FPGA of a National Instruments controller, [7] taking into account all the constrains of the LLRF system, i.e., 18-bit inputs every 9 MHz and a 81 MHz clock, which means that the calculation has a 3.9 μ s latency.

RESULTS

In order to provide proper inputs to the FPGA code, the different cavities behavior controlled by the LLRF system has been simulated using Simulink. A gain scan of the Proportional-Integral controller was performed for the different cavities to optimize the control. At a certain time, quench is simulated as a Q_0 drop from its superconducting value. All the signals are then sent to the FPGA where the calculation takes place.

Figure 2 shows the $\omega_{1/2}$ FPGA estimation of the bERLinPro's gun cavity compared with the simulation with a hard quench at 10 ms. In this case the Q_0 drop follows a step function. In can be seen that the error is below 1%.

A zoom of the $\omega_{1/2}$ estimation compared to the dissipated energy in the cavity walls is depicted in Figs. 3-7 for the different parameters as in Table 1 and for soft quenches starting at 2 ms where Q_0 is following an exponential decay. It is clear that when the change is above the noise level, the dissipated power still is in the order of tens of mJ. It can be seen that the FPGA estimation follows well the actual value of the detuning.

CONCLUSIONS AND FUTURE WORK

These first results show that the $\omega_{1/2}$ estimator using the typical LLRF signals is fast enough to detect a soft quench for all the SRF cavities of the current HZB's projects. Moreover, as this estimator is going to be implemented in the LLRF system, it can be used to quickly switch the RF off.

The next step is implementing this estimator using VHDL code and integrating it in the LLRF firmware developed by DESY for the mTCA architecture. Following this year a TESLA cavity equipped with Oscillating Superleak Transducers (OST) [8] will be installed in the HoBiCaT testing cryomodule which will be used to test, among other things, the quench detection.

Content from this work may be used under the terms of the CC BY 3.0 licence (© 2019). Any distribution of this work must maintain attribution to the author(s), title of the work, publisher, and DOI

It is also planned to substitute the divider by a Piecewise linear interpolator as it was presented in [5], which would reduce the latency of the calculation dramatically and to introduce a low-pass filter at the output of the calculation to remove some spikes that appear at certain cases.

Although not shown in this paper, the $\Delta\omega$ was also implemented and it is foreseen to use it to try to detect the detuning caused when switching from the superconducting penetration depth to the skin effect of the normal conducting state.

Finally, in order to make this method suitable for quench detection in a machine in operation, the beam current needs to be included in equations (1-2), and introduced in the FPGA implementation with the following equation:

$$\omega_{1/2} = \frac{I_c(2KI_f + K_B I_B - \frac{dI_c}{dt})}{I_c^2 + Q_c^2} + \frac{Q_c(2KQ_f + K_B I_{Q_B} + \frac{dQ_c}{dt})}{I_c^2 + Q_c^2} \quad (3)$$

where I_B and Q_B are respectively the components of the beam current and K_B is a scaling factor.

ACKNOWLEDGEMENTS

Authors would like to thank Radoslaw Rybaniec from Paul Scherrer Institut for his valuable comments.

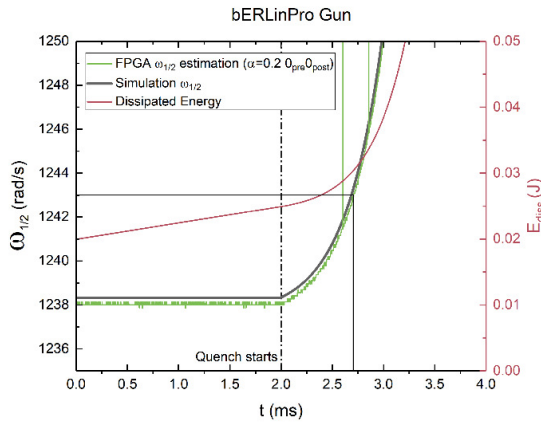

Figure 3: $\omega_{1/2}$ estimation for a soft quench compared to the dissipated energy in the cavity walls for bERLinPro's gun with $Q_0=5 \cdot 10^9$ and $E_{acc}=12$ MV/m.

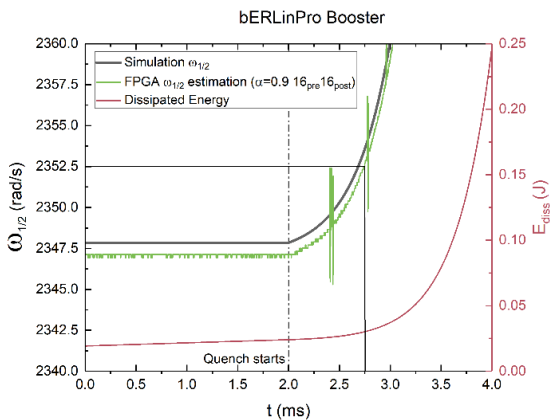

Figure 4: $\omega_{1/2}$ estimation for a soft quench compared to the dissipated energy in the cavity walls for bERLinPro's booster with $Q_0=5 \cdot 10^9$ and $E_{acc}=10$ MV/m.

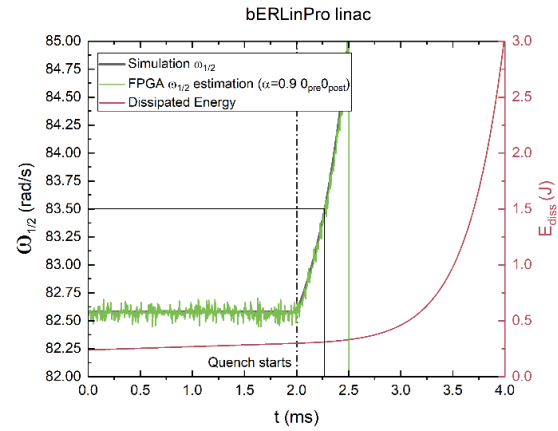

Figure 5: $\omega_{1/2}$ estimation for a soft quench compared to the dissipated energy in the cavity walls for bERLinPro's linac with $Q_0=5 \cdot 10^9$ and $E_{acc}=20$ MV/m.

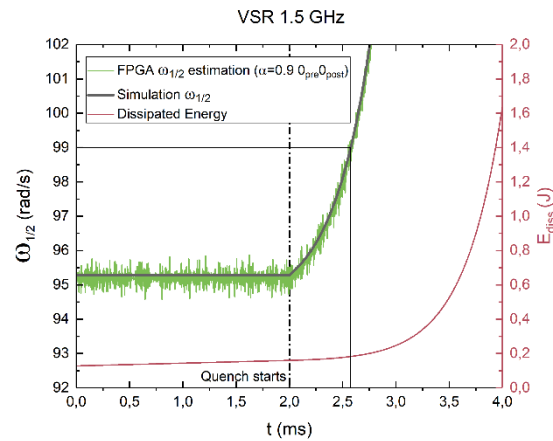

Figure 6: $\omega_{1/2}$ estimation for a soft quench compared to the dissipated energy in the cavity walls for BESSY-VSR@1.5 GHz with $Q_0=5 \cdot 10^9$ and $E_{acc}=20$ MV/m.

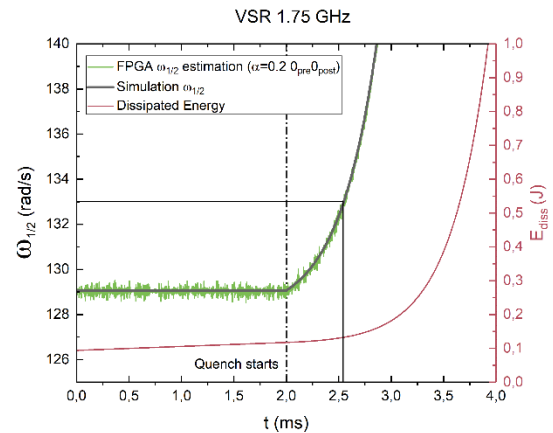

Figure 7: $\omega_{1/2}$ estimation for a soft quench compared to the dissipated energy in the cavity walls for BESSY-VSR@1.75 GHz with $Q_0=5 \cdot 10^9$ and $E_{acc}=20$ MV/m.

This is a preprint — the final version is published with IOP

REFERENCES

- [1] P. Schnizer *et al.*, “Status of the BESSY VSR Project”, in Proc. 9th Int. Particle Accelerator Conf. (IPAC’18), Vancouver, BC, Canada, Apr. 4., pp. 4138-4141, doi:10.18429/JACoW-IPAC2018-THPMF038.
- [2] A. Neumann, *et al.*, "Update on SRF Cavity Design, Production and Testing for BERLinPro", in Proc. 17th International Conference on RF Superconductivity, Whistler, BC, Canada, 13-18, 2015, paper THPB026, pp. 1127-1131, ISBN: 978-3-95450-178-6, doi:10.18429/JACoW-SRF2015-THPB026.
- [3] J. Branlard, V. Ayvazyan, O. Hensler, C. Schmidt, H. Schlarb, and W. Cichalewski, “Superconducting cavity quench detection and prevention for the European XFEL”, in *Proc. of ICALEPS2013*, San Francisco, USA, October 2013, pp. 1239-1241.
- [4] P. Schnizer *et al.*, “Machine Protection Analysis for BESSY-VSR”, presented at the 10th Int. Particle Accelerator Conf. (IPAC’19), Melbourne, Australia, May 2019, paper TUPGW027, this conference.
- [5] R. Rybaniec *et al.*, “Real time estimation of superconducting cavities parameters”, in *Proc. 5th Int. Particle Accelerator Conf. (IPAC’14)*, Dresden, Germany, June 2014, pp. 2456-2458. doi: 10.18429/JACoW-IPAC2014-WEPME075
- [6] K. Przygoda "Development of Control System for Fast Frequency Tuners of Superconducting Resonant Cavities for FLASH and XFEL Experiments", PhD thesis, Technical University of Lodz, Poland, 2010.
- [7] NI 7935R, <http://www.ni.com>
- [8] Y. Tamashevich, “Advanced OST System for the Second-sound Test of Fully Dressed Cavities”, in Proc. 18th Int. Conf. on RF Superconductivity (SRF’17), Lanzhou, China, July 2017, paper THXA06, pp. 703-707, ISBN: 978-3-95450-191-5, <https://doi.org/10.18429/JACoW-SRF2017-THXA06>, 2018.