

Content from this work may be used under the terms of the CC BY 3.0 licence (© 2019). Any distribution of this work must maintain attribution to the author(s), title of the work, publisher, and DOI

DESIGN OF A COMPACT POWER DISTRIBUTION SYSTEM FOR THE ILC

B.T. Du[†], T. Matsumoto¹, S. Michizono¹, T. Miura¹, F. Qiu¹, N. Liu,
 The Graduate University for Advanced Studies (SOKENDAI), 240-0193, Hayama, Japan
¹also High Energy Accelerator Research Organization (KEK), 305-0801, Tsukuba, Japan

Abstract

The Local power distribution system (LPDS) of the International Linear Collider (ILC) is constructed to transmit RF power from the 10 MW klystron to 39 cavities. Each eight or nine 9-cell cavities is assembled in one cryomodule. The variable hybrid is used to adjust the power dividing ratio due to the different required power of each cavity and the variable phase shifter is used to compensate the phase drift caused by the variable hybrid.

More compact LPDS is expected to be integrated on the cryomodule decreasing financial cost. We re-design the shorter variable hybrid with a margin of power ratio of $\pm 25\%$ and phase shifter of total phase range being 35° for compensating hybrid and on-crest searching. Fixed phase shifters are designed to adjust the phase difference between adjacent cavities for beam acceleration. Simulated results of total compact LPDS can meet the requirements of ILC.

INTRODUCTION

The International Linear Collider (ILC) is a 250 GeV linear electron-positron collider, based on the 1.3 GHz superconducting radio-frequency technology. Figure 1 shows the power distribution system (PDS) for the LC as described in the ILC technical design report (TDR) [1]. A 10MW multi-beam klystron is used as a power source to drive 39 Tesla type 9-cell super conducting cavities. Each cryomodule has 8 or 9 cavities. Figure 2 shows the local PDS (LPDS) for ILC as described in the ILC TDR. Each PDS contains three LPDS. Each LPDS is fed 3.33 MW from main variable hybrid to distribute power to 13 cavities by three power dividers and 10 secondary variable hybrids. Under the condition of equal power driving cavities, the average accelerating gradient is expected to be 31.5 MV/m. The TDR indicate that this gradient would have a variation of $\pm 20\%$, owing to the manufactured differences.

LPDS contains variable hybrids, variable phase shifters and fixed phase shifters [2]. The variable hybrids are used to adjust the power ratio to each cavities. The phase relationship between cavities drifts when the power ratio changes. The variable phase shifters are used to compensate this phase drift and on-crest search. The geometrical length between adjacent cavities is 1326 mm, which is $5.75 \lambda_0$ (λ_0 is wavelength in free space at 1.3 GHz). The fixed phase shifters can adjust the phase relationship between cavities before using the variable phase shifters for beam acceleration.

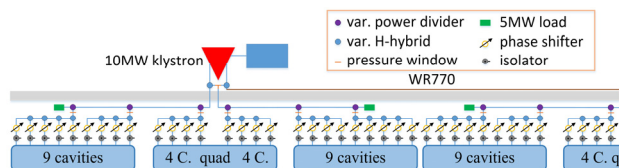

Figure 1: PDS for ILC in ILC TDR [1].

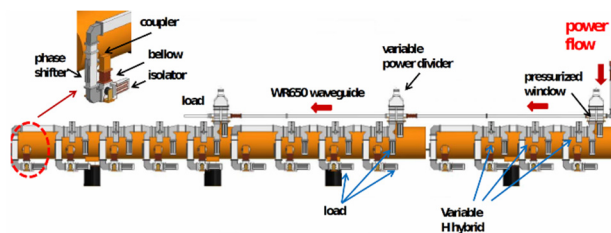

Figure 2: LPDS for ILC in ILC TDR [1].

Considering the LPDS from the ILC TDR, each variable phase shifter can only adjust the phase of a single cavity. The phase drift of each hybrid is accumulated for all subsequent cavities. This increases the maximal required phase range of the variable phase shifter which, resulting in its long geometrical length. Thus, the vertical length of the LPDS is more than the diameter of the cryomodule. Under this condition, the cryomodule can only be assembled in the tunnel first. Then, the LPDS is connected to the cryomodule. Assembly difficulty is generated and more tunnel space is required. The LPDS is expected to be totally integrated on the cryomodule before the cryomodule is assembled in the tunnel. Additionally, the number and lengths of the waveguides is expected to decrease because the total number of RF units and cavities of ILC being 236 and approximately 8,000 for 250 GeV respectively [3].

Figure 3 shows the LPDS in the Super-Conducting RF Test Facility (STF) at the High Energy Accelerator Research Organization (KEK), which applies superconducting technology for the ILC. During operations from January through March 2019, beam acceleration was demonstrated with nine cavities. The feasibility of LPDS was verified in the STF.

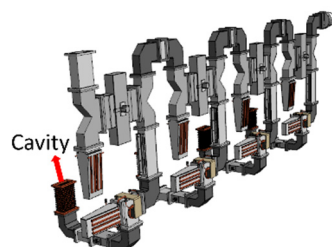

Figure 3: LPDS in the STF.

[†] baiting@post.kek.jp

To design the compact LPDS for the ILC, we first consider the possible model in which the hybrids and variable phase shifters are on the main line of LPDS. This design reduces the height of the LPDS. Then, we design a shorter hybrid and shorter variable phase shifter based on geometrical, power distribution, and phase adjusting requirements. Then, the total compact LPDS is simulated.

MODEL OF COMPACT LPDS

Figure 4 shows the model of the compact LPDS for left (upper) and right (below) directions. For the chain of five cavities, four variable hybrids, five variable phase shifters, four fixed phase shifters and 14 H-corners are used. Variable hybrids, variable phase shifters and fixed phase shifters are arranged on the main line to reduce the vertical length of LPDS and to decrease the number of waveguides. The distance between each cavity is 1,326 mm, which is $5.75 \lambda_0$.

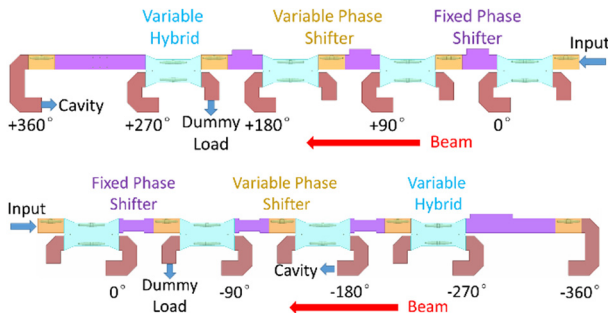

Figure 4: Model of compact LPDS.

DESIGN OF RF COMPONENTS FOR COMPACT LPDS

For super-conducting cavities with very low power loss, optimal tuning the reflected power from cavity is critical, the minimal generated power $((P_g)_{\min})$ is shown by Eq. 1 [4]. V_{cav} is cavity voltage, proportional to accelerating gradient. I_{b0} is the DC component of beam current. ϕ_b is the beam phase defined between the beam current and the cavity voltage. Thus, $(P_g)_{\min}$ is approximately proportional to the accelerating gradient. From the ILC TDR, the average accelerating gradient of a 9-cell cavity is 31.5 MV/m with a variation of $\pm 20\%$ caused by the manufactured differences. The input power of cavities should have a power margin of $\pm 25\%$.

$$(P_g)_{\min} \approx V_{cav} \cdot I_{b0} \cdot \cos \phi_b \quad (1)$$

Figure 5 shows the model of the compact variable hybrid. The length is 630 mm. Two metallic fins are moved symmetrically to adjust the power distribution. Two fixed metallic posts are set at symmetrical positions to reduce the reflection of the four ports [2]. Based on the power margin of $\pm 25\%$, the variable hybrid should have the coupling power ratio (S31) from -8.24 to -2.04 dB.

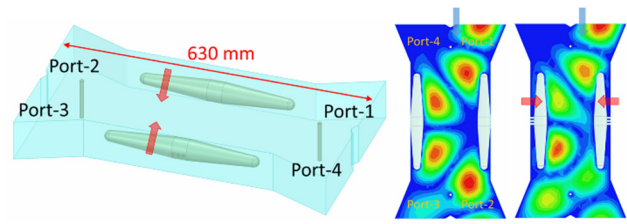

Figure 5: Model of compact variable hybrid.

Figure 6 shows the simulated S parameter of the compact variable hybrid. When the fin is moved from 0 to 14.7 mm, the S31 is changed from -9.95 to -2.57 dB. This range can cover the required S31 from -6.99 to -3.01 dB for the average power distributed condition, and S11 and S41 are both less than -23 dB. For the power margin of $\pm 25\%$, which need the maximal S31 to be -2.04 dB, the fin must move 18.0 mm, and, S11 and S41 can only be < -19.3 dB. Figure 7 shows the simulated S21 and S31 phase of compact variable hybrid. When the power ratio is changed from the -25% condition to the +25% condition, the maximal phase drift of S21 or S31 is 20.4° .

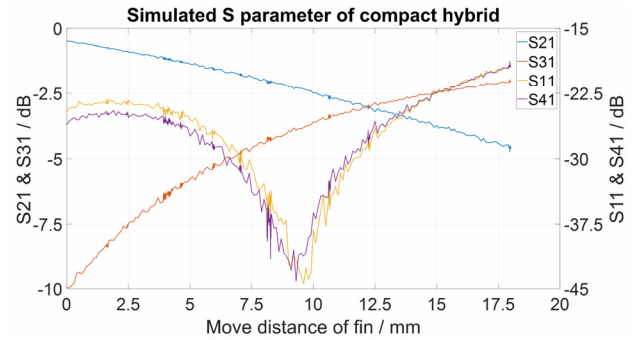

Figure 6: Simulated S parameter of compact variable hybrid.

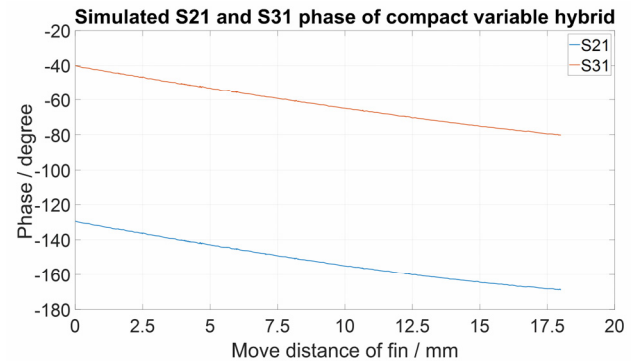

Figure 7: Simulated S21 and S31 phase of compact variable hybrid.

The variable phase shifters are set to compensate the phase drift caused by the variable hybrids. Another 15° for on-crest searching is considered so that a total phase range of 35° is necessary for the variable phase shifters. Figure 8 shows the model of the variable phase shifter. One metallic fin is moved to change the transmitted phase [2]. The length of the variable phase shifter is 300 mm. Figure 9 shows the simulated transmitted phase and reflection power of the variable phase shifter. When the fin is moved

Content from this work may be used under the terms of the CC BY 3.0 licence (© 2019). Any distribution of this work must maintain attribution to the author(s), title of the work, publisher, and DOI

from 0 to 38.5 mm, the phase is changed from 36.0° to 0.8° . The total phase range is 35.2° , and the reflection is less than -33 dB.

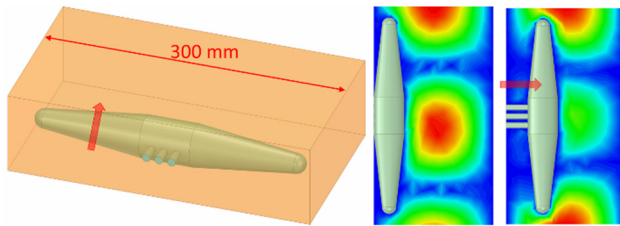

Figure 8: Model of variable phase shifter.

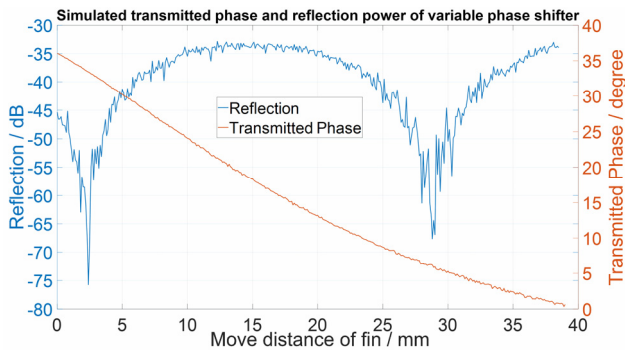

Figure 9: Simulated transmitted phase and reflection power of variable phase shifter.

Under the average power distributed condition and with phase shifter set at the center position of its phase range, the required phase of fixed phase shifter is determined to meet the requirements of beam acceleration. Figure 10 shows the three different ways of shortening wide side and lengthening the wide side, and adding metallic posts for designing fixed phase shifters. A total of eight different fixed phase shifters are designed for left and right compact LPDS.

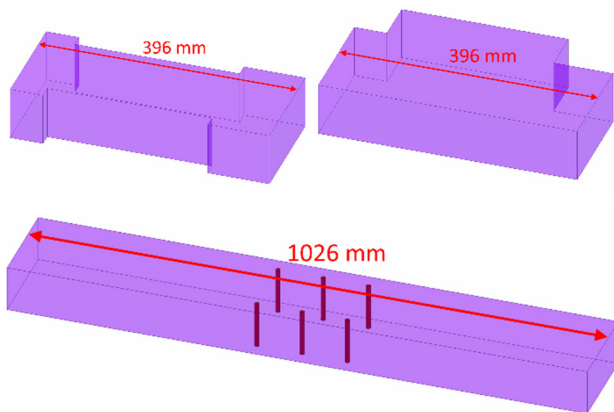

Figure 10: Fixed phase shifters (3 types).

SIMULATED RESULTS OF COMPACT LPDS

Figure 11 shows the simulation of the compact LPDS for left (upper) and right (below) directions. Hybrids are set for average power distribution, and variable phase shifters are set at the center position of its phase range. The maximal

phase difference between simulated and ideal values is 4.3° and 4.8° for the left and right directions, respectively. This can be compensated by the variable phase shifter. The maximal power deviation from the average power distributed case, -6.99 dB for each cavity, is 2.7% and 3.2% for left and right directions, respectively. Superposition of reflection in the LPDS will influence the power transmitted to the cavities. With the input power of 1.3 MW, the maximal electric field is 4.40 and 6.17 kV/cm for left and right directions, respectively. This is lower than 21% of the breakdown field in dry air of 30 kV/cm.

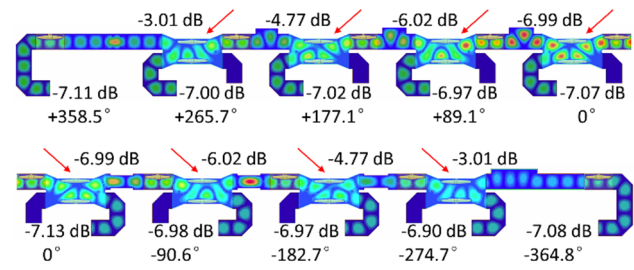

Figure 11: Simulation of compact LPDS.

Each component will be manufactured and tested under high power by the resonant ring [5]. After the high power test of the RF component, the compact LPDS will be constructed to test the variation of power and phase and the stability of the long period. This system is expected to be tested with beam in the STF.

CONCLUSION

The compact variable hybrid, variable phase shifter and fixed phase shifter were designed to meet the requirements of compact LPDS. Simulated results of complete compact LPDS meets the ILC requirements. The compact LPDS will be constructed after the high power test of each component using the resonant ring. The adjustable margin of power and phase will be tested with klystron. The feasibility of compact LPDS is expected to be tested with beam operation in the STF.

REFERENCES

- [1] ILC, <http://www.linearcollider.org/ILC/?pid=1000895>
- [2] S. Kazakov *et al.*, "L-Band Waveguide Elements for SRF Application", in *Proc. 6th Particle Accelerator Society Meeting (PASJ'09)*, Tokai, Japan, Aug. 2009, pp.980-982.
- [3] L. Evans and S. Michizono, "The International Linear Collider Machine Staging Report 2017", Rep. KEK 2017-3, Oct. 2017.
- [4] T. Schilcher, "Vector Sum Control of Pulsed Accelerating Fields in Lorentz Force Detuned Superconducting Cavities", Ph.D. thesis, Phys. Dept., University Hamburg, Hamburg, Germany, 1998.
- [5] B.T. Du *et al.*, "L-Band Resonant Ring for Testing RF Windows for ILC", in *Proc. 29th Linear Accelerator Conf. (LINAC'18)*, Beijing, China, Sep. 2018, pp.679-681. doi: 10.18429/JACoW-LINAC2018-THP0003