

# ACCELERATOR VACUUM TECHNOLOGY CHALLENGES FOR NEXT-GENERATION SYNCHROTRON-LIGHT SOURCES

P.He<sup>†</sup>, Institute of High Energy Physics, CAS, Beijing, P.R.China

## Abstract

A global wave today to construct (or re-construct) ring-based LSs having low horizontal emittance  $\epsilon_h$  (in the range of a few tens of pm.rad) to gain the high brilliance photon beam. Optimal ring structure from DBA, TBA lattice to MBA (Multiple Bend Achromat) has been developed, which is compact lattice combined with small magnet apertures. Such requirements present a challenge for the design and performance of the vacuum system. The main issues of low emittance ring vacuum system are providing the effective pumping and handling the higher SR power. Due to the smaller magnet bore radius and tight longitudinal space limitation, the conventional lumped pumping method may not provide the required vacuum pressure for machine operation; also the lumped crotch absorber may no space to be installed. The development trend of vacuum system for future next-generation synchrotron light source storage rings will use the distributed pumping (NEG coating), distributed absorber (good thermal conducting material vacuum chamber wall). In situ baking for NEG activation and some specific hardware development will also be covered in this paper.

ent quadrupole will be applied for all of these ring-based future Light Source (LS). In order to accomplish a low-emittance electron beam, the storage ring should be designed to accommodate a large number of magnets and try to reduce the size of the magnet units. The small magnet radius and space limitation, it has an impact on the vacuum system design, as the conductance of the vacuum chamber becomes smaller (the conductance of a long circular tube is directly proportional to the third power of the tube diameter) making it difficult to provide the effective pumping speed. On the other hand, the small apertures in the magnets make it more challenging for the vacuum system to handle the synchrotron radiation (SR) power deposited on the chamber wall, so the detailed evaluation of vacuum profiles along the ring will be needed. In such cases, the novel distributed pumping and distributed photon absorber technique has been developed to meet the vacuum requirements for next-generation synchrotron-light sources. In the following sections, we will illustrate the different vacuum system design in the different machine around the world, the pros/cons of the different approach will be mentioned.

## INTRODUCTION

High quality photon beams often characterized in terms of brilliance[1]:

$$\text{Brilliance} = \frac{\text{Photons}}{\text{Second} \cdot \text{mrad}^2 \cdot \text{mm}^2 \cdot 0.1\% \text{BW}} \propto \frac{I}{\epsilon_x \epsilon_y}$$

$I$ : Beam current,  $\epsilon_x, \epsilon_y$ : Transverse emittance

For increasing the brilliance of photon beam, one main approach is lowering the electron beam transverse emittance. The new generation of synchrotron light sources is designed to have an electron beam that has a very small emittance, which allows the photon beam to approach the diffraction limit[2]. Projects of ultra-small emittance storage rings have been launched around the world, the some new facilities design parameters are summarized in Table 1. Multiple Bend Achromat (MBA) lattice and high gradi-

## VACUUM CHAMBER

The next-generation light source storage ring vacuum system has to be designed in such way which is compatible with a multi-bend achromat (MBA) compact lattice. Three different approaches have been developed:

- 1) Conventional chambers with antechambers: [EBS(France) and SPRING8\_II(Japan)] This mature technique has lower risk and more reliability for the machine operation and less maintenance time. But it has more interrupt with magnet design and has more impedance effect for the beam stability.

Table 1: New Ring-Based LS's Parameters

Facility	C(m).	E(GeV)/I(A) $\epsilon_x(\text{pm.rad})$	Mag. Bore(mm)	Chamber Material	Baking Method
MAX-IV (Sweden)	528 (20cell-7BA)	3/0.5 330	25	OFS Cu (100% NEG Coating)	Ex-situ
SIRIUS (Brazil)	518.4 (20cell-5BA)	3/0.5 250	28	OFS Cu (100% NEG Coating)	In-situ
EBS (France)	844 (32cell-7BA)	6/0.2 135	26	SST/Al (Partial NEG Coating)	In-situ
SPring-8_U (Japan)	1436 (48cell-5BA)	6/0.1 140	26	SST (No NEG Coating)	Ex-situ
APS_U (USA)	1100 (40cell-7BA)	6/0.2 60	26	OFS Cu/Al (Partial NEG Coating)	Ex-situ

<sup>†</sup>heping@ihep.ac.cn

- 2) All NEG-coated copper tubes: [MAX\_IV(Sweden) and SIRIUS(Brazil)] This novel technique by using distributing pumping can provide the required vacuum pressure for machine operation inside the very narrow vacuum tube and also will minimum compromises to magnet design. But it has more risk and may have higher cost.
- 3) Hybrid design which combines conventional chambers incorporating “antechambers” with a variety of simpler tubular chambers made variously of copper-plated stainless steel, and NEG-coated copper tube in the FODO section: [APS\_U(USA)] This option has good vacuum performance and lower impedance effects compare with conventional chambers with antechambers. And also has advantages over an all NEG-coated copper system with regard to overall project risk, required installation time, and maintainability. It has moderate cost.

The general requirements for vacuum chamber have to be considered for the cost, performance, and required maintenance, these factors will led to a design by which the details of the chamber construction varies according to local spatial constraints and SR loading. The magnets of the compact MBA lattice storage ring have a small aperture of diameter 25~28mm[3,4,5]. As a result, the vacuum chambers within the magnets have a 22~24 mm inside diameter with 1 mm wall thickness. Distributed cooling channels are welded to the chambers allowing the power deposited by SR to be safely removed. The clearance between the chambers and the magnets poles is 0.5~1 mm; the chambers are produced with tight mechanical tolerances to avoid any interference with the magnet poles and coils (for example, all tolerances of the chambers should be less than 0.3 mm).

Type I: EBS design: Three main families of chambers

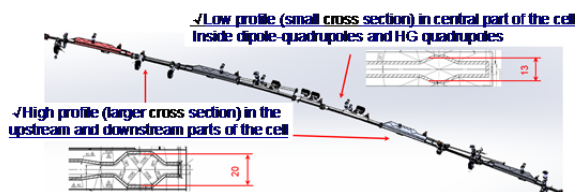

Figure 1: EBS one standard cell.

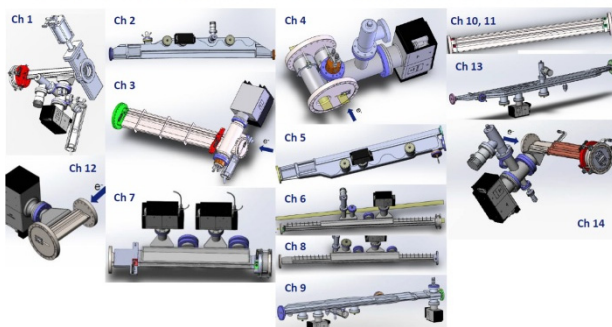

Figure 2: All kinds of EBS vacuum chambers.

along the ring(Fig.1): a) High profile aluminium chambers (dipole magnets + other). b) High profile stainless steel chambers (quadrupoles, sextupoles, octupoles). c) Low profile stainless steel chambers (inside combined dipole-quadrupoles + HF quadrupoles). Typically 1.5mm chamber wall, 1mm min. gap chamber ext. wall to magnets poles. Totally, ~450 Aluminium & stainless steel(14 types) chambers for the storage ring(Fig.2). The pumping will mainly use lumped(discrete) UHV pumps rather than functional coatings. Total 15 SIP(55l/s ~150l/s) and 8 NEG cartridge pumps(200l/s) are installed at one standard cell. Only Ch01 and CH14 which near the ID straight section will be NEG coated to provide the additional pumping for the ID chamber.

Type II: SIRIUS design: The storage ring pumping will be based mainly on NEG (non evaporable getter) film, where the proposal is to have more than 90% of the OFS copper chambers NEG coated with the exception of the pulsed magnets, a few diagnostic components and the RF cavities. Only 5 pumping stations per superperiod: 20 l/s SIP (post dipoles)(Fig.3,4,5,6).

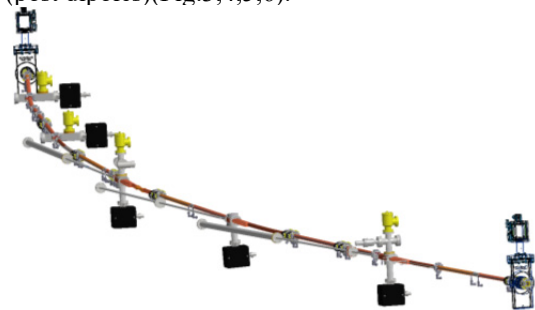

Figure 3: SIRIUS one cell layout.

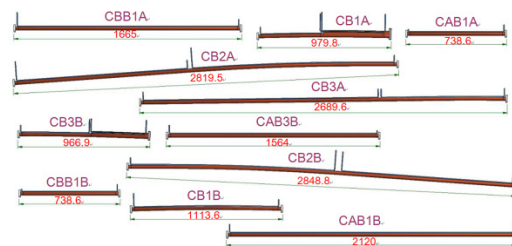

Figure 4: SIRIUS OFS copper chambers.

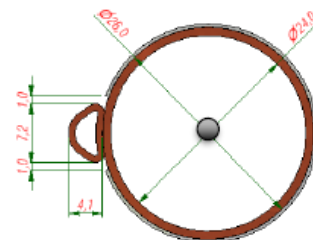

Figure 5: Cross-section of SIRIUS multipole chambers.



Figure 6: Dipole chamber with key-hole photon exit.

Type III: APS\_U design: One standard cell has about 28 chambers(Al + copper tube). Nine sections will be installed with magnet as integrated modules. L-bend Sections: Extruded aluminium chambers with water channels and antechambers that house NEG strips and photon absorbers. Quad Doublet/Straight Multiplet Sections: Simple tubular chambers with water-cooling channels made of extruded aluminium. FODO Section: NEG-coated copper vacuum chambers with water channels address high thermal and gas loading from bending magnet radiation. Vacuum pumps: seven discrete active pumps, NEG strips in L-Bend ante-chambers, NEG coating in FODO section between gate valves(Fig.7,8,9).



Figure 7: APS\_U standard half cell.

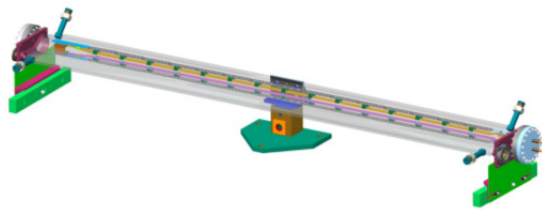

Figure 8: APS\_U dipole chamber.

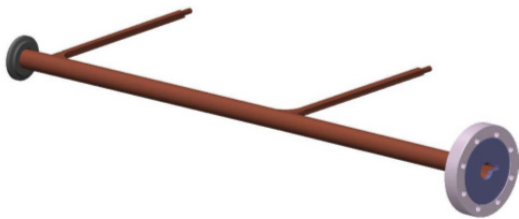

Figure 9: APS\_U FODO section chamber.

To limit the impact of eddy current shielding of fast steering correction fields, vacuum chambers in that area will be made of stainless steel alloy or Inconel, which has an exceptionally low electrical conductivity. The interior surface, however, will be plated with copper to minimize impedance.

**HANDLE HIGH SR POWER**

The total power from SR is proportional to the beam current and the fourth power of the beam energy, and inversely proportional to the bending radius of the dipole magnet[6], while the power density is proportional to the fifth power of the beam energy.

$$P_{SR} = \frac{88.5E^4 I}{\rho}$$

For MAX IV, beam energy is 3GeV, when the beam current=500 mA[7], the maximum power density on the vacuum chambers is 9.4 W/mm<sup>2</sup>; accordingly MAX IV was able to use the chamber body as an absorber of the SR power. This was possible as the maximum stresses and temperatures due to this power were within the design criteria for OFS copper(Fig.10).

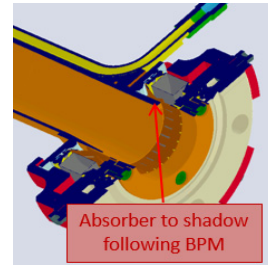

Figure 10: MAX IV chamber absorber.

For APS\_U, E=6GeV, I=200mA, the maximum power density on the FODO section vacuum chamber wall is about 11W/mm<sup>2</sup>, they change the in-line absorber stub material used at this area from OFS copper to Glid-cop(AL-15, alumina dispersion strengthened copper) which has high thermal conductivity comparable to that of OFHC copper and can withstand higher stress, also make special cooling design(Fig.11) for the in-line absorber.

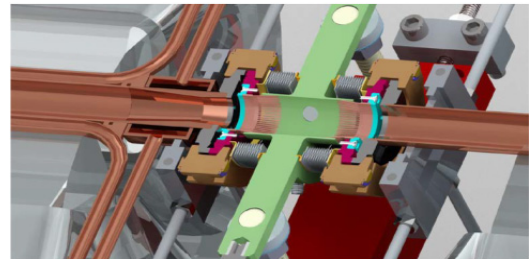

Figure 11: APS-U in-line absorber GlidCop stub.

For other machines, if the SR power and the power densities go even higher, it may take other design philosophies; For example, EBS project it design the vacuum chamber with an antechamber where the power is absorbed using lumped absorbers could be adapted. Clearly, this needs to be considered in the design of the lattice and magnets. The chamber design is more complicated, adding difficulties for their production.

The EBS have 12 lumped removable photon absorbers (on flanges) per cell(Fig.12). The design has been done such that the absorbers take scattered photons as well, thus avoiding to have to water-cool the vacuum chambers.

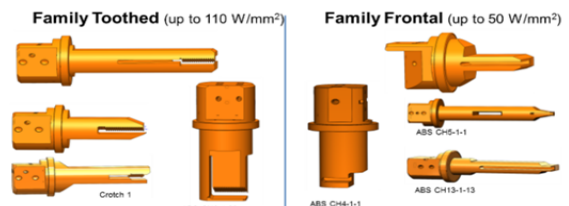

Figure 12: EBS CuCrZr photon absorbers.

These absorbers will be machined from a block Cu-CrZr, including the CF knife edge. This eliminates the

expensive and time consuming process of brazing the main body of the absorbers to SS Conflat flanges. The material CuCrZr(C18150) compare with GlidCop(AL-15), they have similar physical and mechanical properties: thermal conductivity, coefficient of thermal expansion, elastic modulus, etc. The CuCrZr cost much less than GlidCop(AL-15), also it readily available in different forms and sizes from many suppliers. But CuCrZr will lose its strength rapidly if exposed to sustained temperature over 500° C. So CuCrZr can be used as high heat load components material when the brazing is not needed. The GlidCop is the choice if brazing is required.

### NEG COATING FOR DISTRIBUTING PUMPING

Non Evaporable Getter (NEG) films, sputter deposited onto the internal surfaces of vacuum chambers reduce thermal out-gassing and provide conductance-free distributed pumping ability, allowing the achievement of very low pressure inside narrow and conductance limited vacuum chambers. NEG films do show additional interesting features, like low secondary electron yield and low gas desorption rates under ions, electrons and photons bombardment. They seem therefore ideal to provide pump-port free distributed pumping and reduce dynamic gas desorption induced beam instabilities in the ultra-low emittance compact lattice storage ring.

NEG are materials capable of chemically absorbing gas molecules after heating to a temperature high enough to dissolve the native oxide layer into the bulk. After the activation, NEG materials can pump most of gas species except rare gases and methane.

To ensure the NEG coating in the good quality, the chamber surface treatment need very carefully preparation, normally include three steps: degreasing, followed by etching, and finally passivation. And then, sputtering procedure parameters have to be optimized for the different aperture vacuum chamber. Coating on the very small aperture even <10mm chamber and photon extraction key hole (~6mm gap) is more challenging. Finally, the coating characterization has to be performed to assure the film composition and thickness, also morphology.

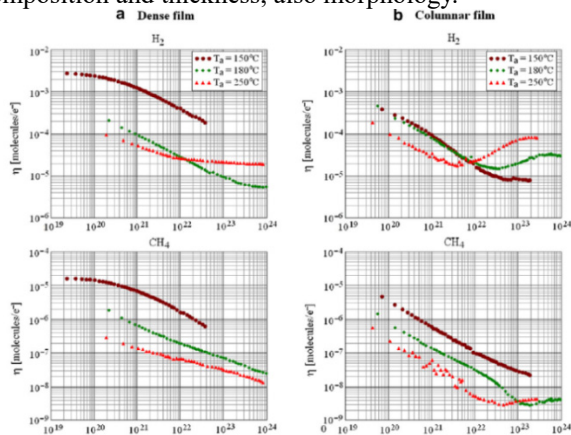

Figure 13: ESD yields, h, as a function of electron dose for samples activated at 150° C, 180° C and 250° C.

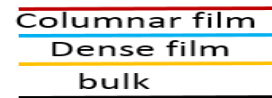

Figure 14: Double layer coating.

Experiential data[7] show that the NEG coating with a columnar structure demonstrates, as expected, a higher pumping speed and capacity for H<sub>2</sub>, CO and CO<sub>2</sub> after activation at 150° C, 180° C and 250° C than the one with a dense film. Also ESD yields as a function of specific electron dose are shown in Fig. 13, after activation at higher temperatures the ESD yield for H<sub>2</sub> at large doses for the columnar NEG coating could be increase. So the better solution of NEG coating benefit from the low desorption yields and the high pumping speed and capacity is that use double-layer NEG coating, a protective layer (dense NEG coating) firstly coated on the vacuum chamber material and a columnar NEG add on it(Fig.14).

### SPECIFIC HARDWARE DEVELOPMENT

Innovative designs of new vacuum components with reduced coupling impedance are being made: more gentle taper transition, no gap between vacuum connection flanges, RF shielded bellows, round chambers improve geometric impedance, smaller cross section and so on.

The ‘zero impedance’ flange(circular and non-circular) with no slit and no step between the two flanges developed at Sirius[8], on the basis of the model developed at KEK[9]. An additional effort is made so that an electron only sees copper in traversing a flange(Fig.15).

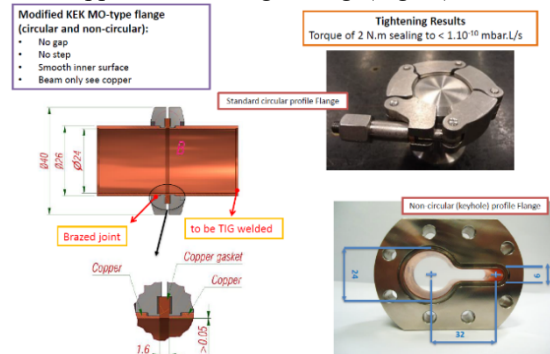

Figure 15: zero impedance flange.

The other effort to reduce the impedance is design different type of RF shielded bellows. The conventional RF shielded bellows have inside finger and outside finger design. The Super KEKB project has developed the comb-type RF shielded bellow[10], it has a structure of nested comb teeth(Fig.16), and has higher thermal strength and lower impedance than the conventional finger-type one. The advantages of this kind of RF-shield are: there is now transverse step at inside surface in principle, and the shield has low impedance, the TE-mode like HOM, hardly goes through due to the large radial thickness of teeth, there is no sliding point on the inner surface of beam duct, which otherwise could be a source of acting. The potential disadvantages compared to the finger-type RF shield, on the other hand, are the limited stroke of expansion/contraction.

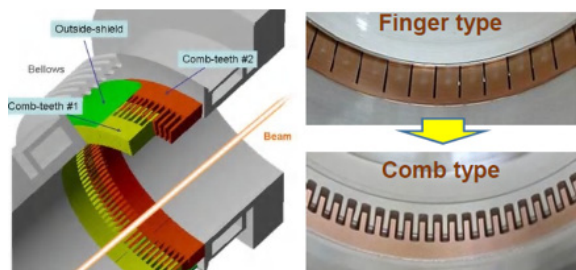

Figure 16: Comb type RF shield.

The omega stripe RF shield was developed at DAΦNE[11]. The RF omega shield is composed of many Be-Cu strips which gold-coated with a thickness of 10 $\mu$ m held by an external floating ring. Thermal power loss on strips can be easily extracted and dissipated allowing high beam current operation. Leakage of beam induced electromagnetic fields through the RF shield is almost suppressed. For handle the higher heat load, the bellow can be modified to the cooled strips shield as shown in Fig. 17. SIRIUS and EBS are using similar design to make their own in-house omega-shaped bellows. Fig.18 shows this type of bellow loss factor curve which compare with standard finger type bellow.

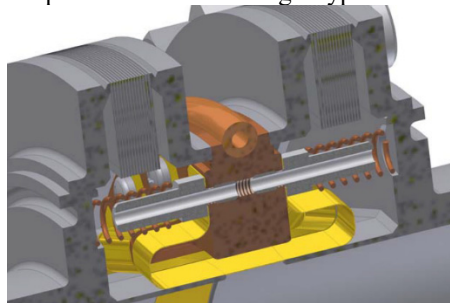
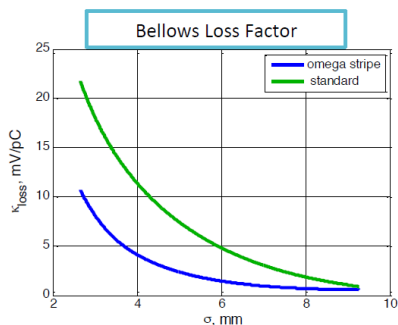

Figure 17: Cooled Omega stripe RF shield.

Figure 18:  $K_{loss}$  curve of two kinds of RF shield.

## IN-SITU BAKING

The NEG-coated chambers should be heated up to activate the NEG. In-situ bakeout where the chamber is covered with heaters and baked while inside the magnets is the best solution. However, there should be sufficient space to place the heaters and insulation between the magnets and the chambers; in addition, and as the chamber will expand, bellows with sufficient stroke should be placed within the vacuum chambers to absorber this deformation without adding stresses to the chambers.

Different configurations of heating element arrangement have been developed. In EBS, sheathed heaters selected as primary source, and covered by aluminum coated PI for the insulation. The tests of shaping insulation coats by means of foam chamber and magnet mockups are shown in Fig.19.

The vacuum system for SIRIUS is being designed to be baked in-situ for NEG coating activation. Polyimide foil heater was adopted and covered by a top aluminium layer reduces radiation heat loss and diminishes the required input power for the bake-out(Fig.20).



Figure 19: EBS in-situ baking test.

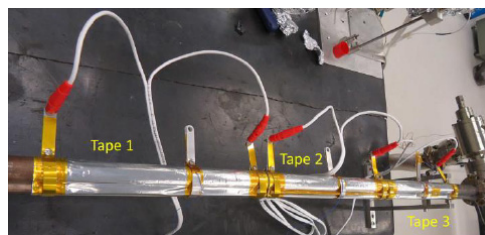

Figure 20: SIRIUS polyimide foil heater.

## CONCLUSION

The vacuum system for the next-generation ring-based LSs has to cope with high synchrotron radiation, high photon flux, intense HOM excitation, strong collective effect, and so on. The low emittance lattice is making the vacuum chambers and components more and more miniature, both transversely and longitudinally, making their designs and vacuum pumping difficult with classical pumps. As the chamber's cross section is reduced, dimensional tolerances become tighter to minimize their contribution to beam instability. For that reason, chamber's design and fabrication are highly dependent of the inputs from impedance calculations, some specific hardware components (flanges, RF shield bellows) design have to be considered.

Vacuum pumping with NEG coating on the other hand is becoming more and more used for the future machines. The use of NEG coated chambers must be considered right on the beginning of the design phase since it has a huge impact on infrastructure, fabrication strategy, cleaning procedures, baking strategy, etc.

## ACKNOWLEDGEMENT

The authors would like to thank the vacuum group of the APS-U, EBS, SIRIUS, SPRING\_8\_U, MAX-IV, KEK\_B, CERN for their input to the paper.

**REFERENCES**

- [1] K.-J. Kim, “Characteristics of synchrotron radiation”, AIP Conference Proceedings no. 184, p.565 (1989).
- [2] Hettel, *J. Synchrotron Rad.* vol.21, pp. 843-855, 2014.
- [3] M. Hahn *et al.*, “Layout of the Vacuum System for anew ESRF Storage Ring”, WEPME026, IPAC’14,Dresden, Germany (2014).
- [4] SIRIUS Design report.
- [5] B.Stillwelle *et al.*, “Conceptual design of a storage ring vacuum system compatible with implementation of a seven bend achromat lattice at the APS”, in *Proc. IPAC’14*, Dresden, Germany, Jun. 2014, paper WEPME059, pp. 2409-2411.
- [6] O. Grobner, *et al.*, *Vacuum*, vol.33, pp 397–406, 1983.
- [7] O. B. Malyshev, *et al.*, *Vacuum*, vol.86, pp 2035–2039, 2012.
- [8] R.M. Seraphim *et al.*, “Vacuum system design for the SIRIUS storage ring”, in *Proc. IPAC’15*, Richmond, USA, May 2015, paper WEPMA003, pp. 2744-2746
- [9] H.Matsumoto *et al.*, “Experience with a Zero Impedance Vacuum Flange at He Super-Leak Temperature for the ILC”, Proceedings of EPAC 2006, Edinburgh, Scotland, p. 753. (2006).
- [10] Y. Suetsugu *et al.*, “Application of Comb-Type RF-Shield to Bellows Chambers and Gate Valves”, Proceedings of PAC 2005, Knoxville, Tennessee, USA, p.3203. (2005).
- [11] S. Tomassini *et al.*, “A New RF Shielded Bellows for the DAΦNE Upgrade”, Proceedings of EPAC08, Genoa, Italy, p.1706. (2008).