

# CAVITY PERFORMANCE OF THE PROTOTYPE KEK SUPERCONDUCTING RF GUN

T. Konomi<sup>#</sup>, E. Kako, Y. Kobayashi, K. Umemori, S. Yamaguchi, KEK, Tsukuba, Ibaraki, Japan  
R. Matsuda, T. Yanagisawa, MHI-MS, Hyogo, Japan

## Abstract

A superconducting RF (SRF) gun can generate high current and low emittance beam. KEK has been developing SRF gun for the KEK ERL project. A feature of the gun is that, the excitation laser inject from backside of the photocathode. The feature can make two merits. One is there is no laser injection mirror and view port on the beam path and in the RF structure. The other is laser focus length can be shortened therefor the laser can be shaped uniform easily. A purpose of the prototype cavity is to test the RF structure of the photocathode and cathode plug structure. The test has been done step by step. 4 times of vertical test has been done. At the 4th vertical test, choke structure was added.

## CONCEPTUAL DESIGN

The target of the SRF gun is the KEK 3 GeV ERL project. Target beam and cavity parameters are listed in Table 1. These parameters based on KEK 3 GeV ERL project. Beam power is determined from the input coupler. Surface peak electric field is designed less than 50 MV/m.

Table 1: Target Parameters of the SRF Gun

Parameter	Value
Beam energy	2 MeV
RF frequency	1.3 GHz
Beam current	100 mA
Pulse length ( $1\sigma$ )	3 ps
Projected emittance	$< 1 \pi$ mm mrad
Projected energy spread	$< 0.1\%$
Number of cells	1.5

## PROTOTYPE CAVITY

The prototype cavity was designed by SUPERFISH and GPT [1]. The space charge effect was compensated by the cathode cell taper. Beam performance is affected by initial slope of the electric field and cell length. Diameter of the end iris also slightly affects to the beam performance. When beam energy set to 2 MeV, it is possible to suppress the surface peak electric field in less than 50 MV/m. Table 2 shows the plan of the prototype cavity vertical test. 7 times vertical tests are planned. 1<sup>st</sup> to 4<sup>th</sup> vertical test was done. At 4<sup>th</sup> vertical test, choke structure was added to the cavity. End of the cathode plug has U-tight seal flange. The cathode plug is unibody structure from 1<sup>st</sup> to 5<sup>th</sup> vertical test. After 6<sup>th</sup> vertical test, the

cathode plug structure will be changed to divided structure to exchange the photocathode substrate [2].

Table 2: Vertical Test Plan

# of VT	Acc. cell	Cathode plug	Choke	Photocathode substrate
1 <sup>st</sup>	○	×	×	×
2 <sup>nd</sup>	○	○	×	×
3 <sup>rd</sup>	○	○	×	×
4 <sup>th</sup>	○	○	○	×
5 <sup>th</sup>	○	○	○	×
6 <sup>th</sup>	○	○	○	○
7 <sup>th</sup>	○	○	○	○

## 1<sup>ST</sup> VERTICAL TEST

RF parameters of the prototype cavity are shown in Table 3. RF field distribution in prototype cavity is shown in Fig.1. Surface peak electric field ( $E_{sp}$ ) located at the cathode cell iris.  $E_{sp}$  target is 42.5MV/m and  $Q_0$  is  $4.5 \times 10^9$ . Target  $Q_0$  is approximately half of the TESLA shape cavity, because the geometrical factor is approximately half.

Table 3: RF Parameters

Parameter	1 <sup>st</sup> VT	2 <sup>nd</sup> & 3 <sup>rd</sup> VT	4 <sup>th</sup> VT
Frequency (GHz)	1.3	1.3	1.3
Geometrical Factor (Ohm)	135.4	135.6	135.3
$H_p/E_p$ (mT/(MV/m))	2.27	2.27	2.24

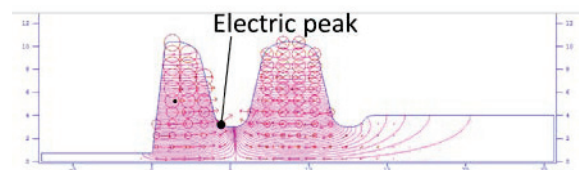

Figure 1: RF distribution of 1<sup>st</sup> Vertical test.

At 1<sup>st</sup> vertical test, the cavity has only accelerating cell without choke, cathode rod and photocathode as mentioned earlier. Figure 2 shows 1<sup>st</sup> vertical test result. Surface peak field reached to 66 MV/m and  $Q_0$  is  $4.3 \times 10^9$ . At the target field 41.9 MV/m, result of  $Q_0$  is  $7.15 \times 10^9$

and meets the target value  $4.5 \times 10^9$ . Although field emission on set is 50 MV/m, it is higher than target field.

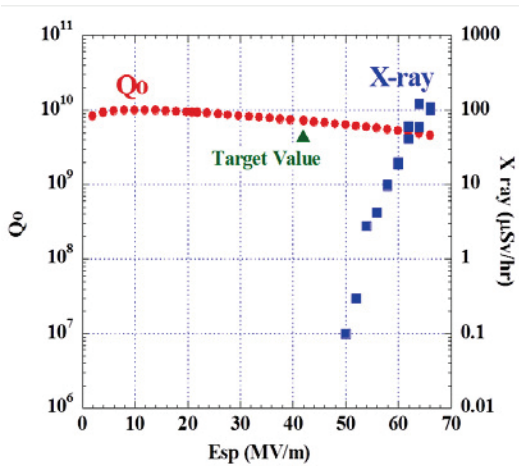

Figure 2: 1<sup>st</sup> vertical test result.

### 2<sup>ND</sup> AND 3<sup>RD</sup> VERTICAL TEST

When cathode plug is inserted to the cavity, accelerating field strongly couples with cathode plug. If there is no choke structure, accelerating field pass through the coaxial line and damped at the end of the cathode plug, because flange material is weak superconductor or normal conductor. The coupling and additional Q load was calculated by the CST and SUPERFISH. 2<sup>nd</sup> and 3<sup>rd</sup> vertical test was done for the verification.

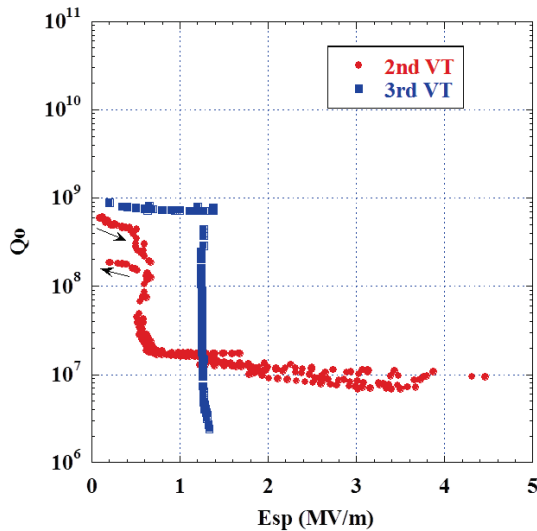

Figure 3: 2<sup>nd</sup> and 3<sup>rd</sup> vertical test.

Figure 3. shows the 2<sup>nd</sup> and 3<sup>rd</sup> vertical test result. Qo was dropped about 1MV/m Esp for both two test. Qo drop point of 3<sup>rd</sup> vertical test is slightly higher than 2<sup>nd</sup> vertical test. The reason is that the shape and material of the cathode plug flange was changed by measurement of 2<sup>nd</sup>

and 3<sup>rd</sup>. At 2<sup>nd</sup> VT, flange was made of NbTi (Fig.4b). Though NbTi is a superconductor, critical RF field is much lower than pure Nb. At 3<sup>rd</sup> VT, flange was made of hard Nb. And it has knife edge to prevent RF power loss at the gasket and flange (Fig.4c). 2<sup>nd</sup> VT Q value at low field (<0.5MV/m) split two lines. This means NbTi flange was quenched by heating. From these measurement, choke filter is required -30dB attenuation to achieve additional loss more than  $10^{11}$

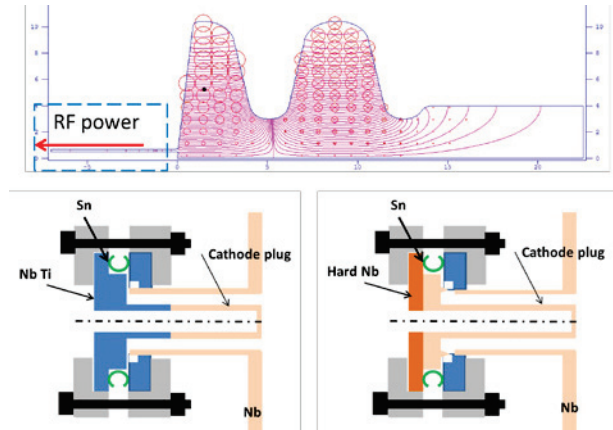

Figure 4: a) RF distribution of 2<sup>nd</sup> and 3<sup>rd</sup> vertical test, b) flange structure of 2<sup>nd</sup> vertical test, c) 3<sup>rd</sup> vertical test (bottom right).

### CHOKE DESIGN

The choke is a simple parallel shape (Fig.5, Table 4). The parallel two face slightly taper to clean easily. Responses of each size were simulated for fabrication error and tuning. Choke is tuned by pushing and pulling the root of the choke. During the tuning, L1 is valuable and L2 is fixed. Choke was machined from large grain Nb, and has high stiffness. Figure 6a shows the response of tuning by CST. The tuning range is wide enough to accept the target attenuation

Fabricated choke frequency was checked and tuned without accelerating cell. Fabrication error of the choke filter could be adjusted by tuning (Fig.6a).

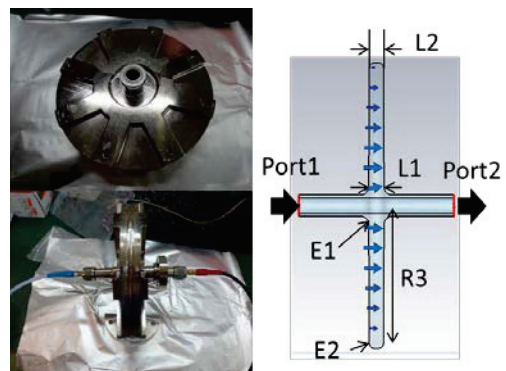

Figure 5: Choke picture and shape and design parameters.

Table 4: Choke Design Parameter

Parameter	Symbol	Value (unit:mm)
Coaxial line outer radius	R1	7
Coaxial line inner radius	R2	5
Choke outer radius	R3	92.178
Choke root thickness	L1	11
Choke tip thickness	L2	10
L1-L2	L1-L2	1
Root radius	E1	4
Tip radius	E2	2

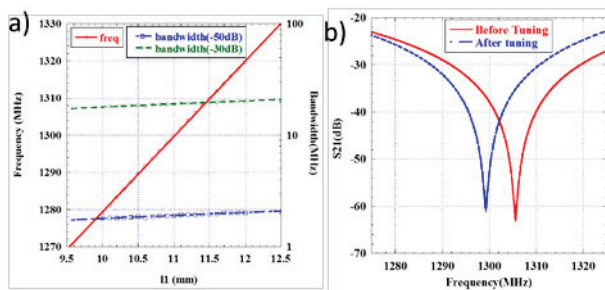

Figure 6: a) Choke tuning simulation, b) Choke bandwidth measurement and tuning.

After welding with accelerating cell, field flatness and choke filter attenuation was measured. Field flattens was not changed. Attenuation was calculated by comparing leak field from cathode plug with and without choke filter. The attenuation was -42dB.

### 4<sup>TH</sup> VERTICAL TEST

Figure 7 shows the picture of the 4<sup>th</sup> vertical test setup. Choke is welded to accelerating cell. 4<sup>th</sup> vertical test result is shown in Fig.8. The maximum field is restricted by the multipacting and field emission at choke.



Figure 7: Picture of the prototype cavity at 4<sup>th</sup> vertical test

Multipacting region is around 3MV/m and the area is supposed at the choke and coaxial line because of the low field. When Qo was dropped, the cathode plug flange was heated (Fig.8b). The multipacting can be skipped by

turning on the power instantaneously. Field emission started at 20MV/m Esp. and transmit power was dropped at 32 MV/m Esp. Figure 8c shows the cathode plug flange heating. It suggested that the choke filter was shorted by the electron emission. The choke surface was not well polished and washed aggressively because the surface field of the choke and coaxial line is about 8% of the surface peak field.

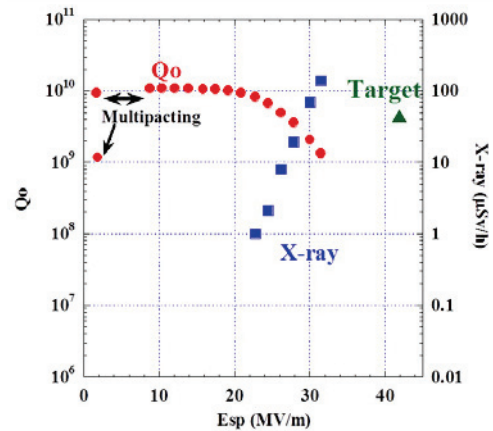

Figure 7: 4<sup>th</sup> vertical test result.

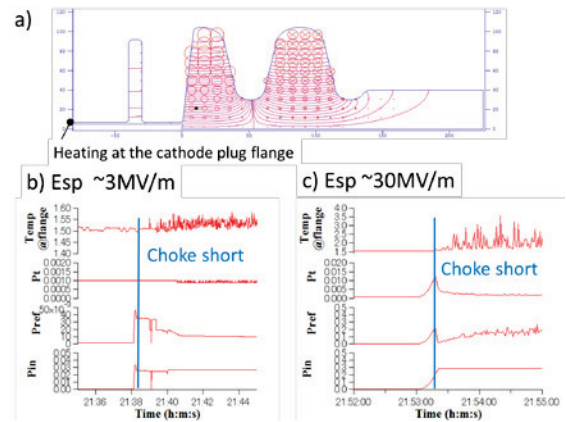

Figure 8: cathode plug flange heating. a) RF distribution and heating location, b) Esp~3MV/m, c)Esp~30MV/m.

### SUMMARY

KEK prototype SRF gun has been developed step by step. Accelerating cell performance satisfies the target Esp and Qo. After welding choke and inserting cathode plug, maximum Esp was restricted by multipacting and field emission at choke and coaxial line. It is suspected that the choke and cathode plug polishing and rinsing are not satisfactory. For 5<sup>th</sup> vertical test, electro polishing jigs and high pressure rinsing nozzle are being prepared.

### REFERENCES

[1] R.Matsuda et al., Proc. of the 11<sup>th</sup> Annual Meeting of Particle Accelerator Society of Japan, MOOL13, (2014).  
 [2] T. Konomi et al., THPB059, SRF2015, Whistler, Canada (2015)