

Progress in Transverse Feedbacks and Related Diagnostics for Hadron Machines

Wolfgang Hofle, CERN BE-RF



Progress in Transverse Feedbacks and Related Diagnostics for Hadron Machines

Wolfgang Hofle

CERN

Beams Department

Acknowledgements: [G. Kotzian](#), [D. Valuch](#), K. Li (CERN)

CERN BE department RF, OP, ABP, BI, CO Groups, TE-ABT Group

V. Zhabitsky (JINR)

[J.D. Fox](#), J. M. Cesaratto (SLAC) for [US LARP](#)

PRINCIPLE OF TRANSVERSE FEEDBACK

Principle of Transverse Feedbacks

- One or multiple pick-ups
Turn by turn, bunch by bunch position with digitization and processing
- Widely used in high intensity lepton colliders (B factories) and light sources to provide beam stability
- High intensity hadron machines need feedback for stability as well
- Use in **hadron** colliders **more challenging** and restricted in past mostly to injection damping (low noise system needed)
- **LHC collider uses TFB all the time including with stored, colliding beams, (protons and Pb ions) since 2010**

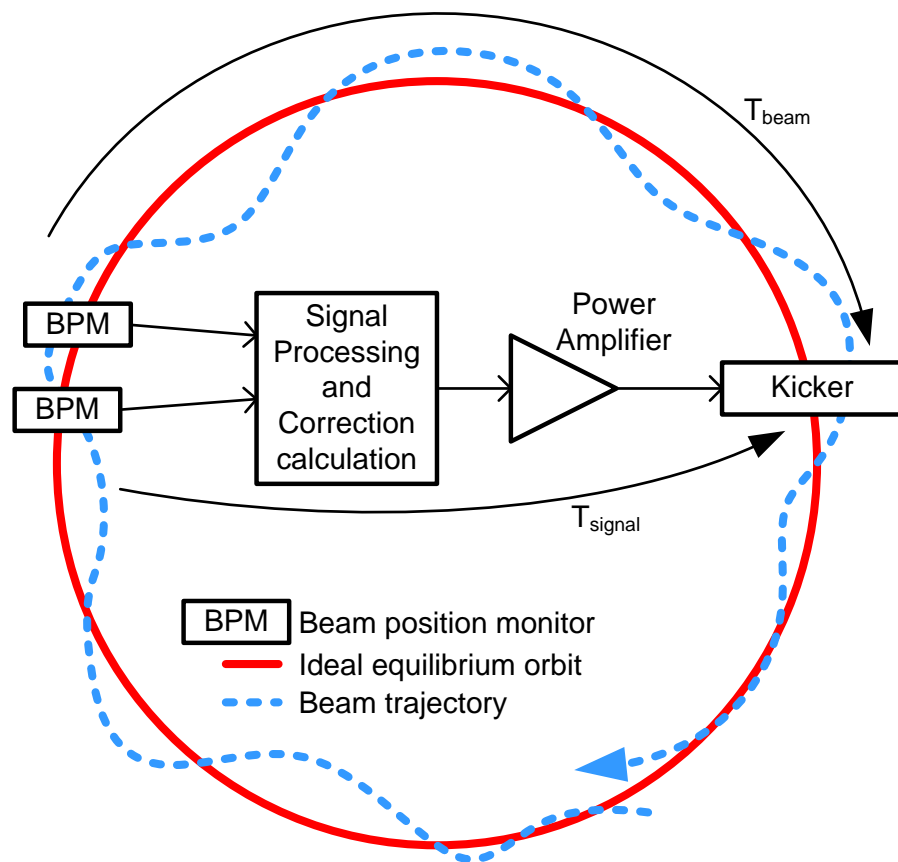

$$T_{\text{signal}} = T_{\text{beam}} + n T_{\text{rev}}$$

Projects and Future Needs for Transverse Feedbacks for Hadron Machines

- **JPARC Main Ring**: Tobiyaama et al. IPAC'10 and TUPWA009
- **GSI, FAIR facility** → planning to have transverse feedbacks
M. Almuhaiddi et al., IPAC'11
- **RHIC** → injection damping, abort gap cleaning
considering an upgrade
- **CERN LHC Injector Upgrade Project (LIU)**:
Upgrades for **PSB**, **PS** and **SPS** transverse feedbacks
→ New generation of digital feedbacks planned
- Two stream instabilities (e-p) → transverse feedbacks working at
proton accumulator rings at **Los Alamos (PSR)** and **ORNL (SNS)**
R. McCrady et al., PAC'07; R. Hardin et al., IPAC'10

Past reviews and overviews: K. Balewski et al. (EPAC'98)
D. Teytelman (PAC'03)
D. Teytelman (PAC'11)

LHC TRANSVERSE FEEDBACK AKA DAMPER / ADT

LHC Transverse Damper (ADT)

- Initially designed for
 - Injection damping
 - Feedback during ramp (coupled bunch instabilities)
- LHC Physics Run 1 (2010-2013)
 - Providing stability at all times in the cycle
(including with colliding beams !)
 - Diagnostics tool to record bunch-by-bunch oscillations
 - Abort gap and injection cleaning
 - Blow-up for loss maps and aperture studies
 - Tool to produce losses for quench tests
 - Tune measurement (under development)

LHC Transverse Damper Specs

Injection beam momentum	450	GeV/c
Static injection errors ($\beta = 183$ m)	2	mm
ripple ($\beta = 183$ m)	2	mm
resistive wall growth time	14	ms
decoherence time	68	ms
tolerable emittance growth	2.5	%
overall damping time	4.7	ms (53 turns)
standard bunch spacing	25	ns
lowest betatron frequency	> 2	kHz
highest frequency to damp	20	MHz
Electro-static kickers		base band
aperture of kickers	52	mm
number of kickers per plane and beam	4	
length of kicker plates	1.5	m
nominal voltage up to 1 MHz	± 7.5	kV
kick per turn at 450 GeV/c up to 1 MHz	2	μ rad

ADT Power and Kicker System

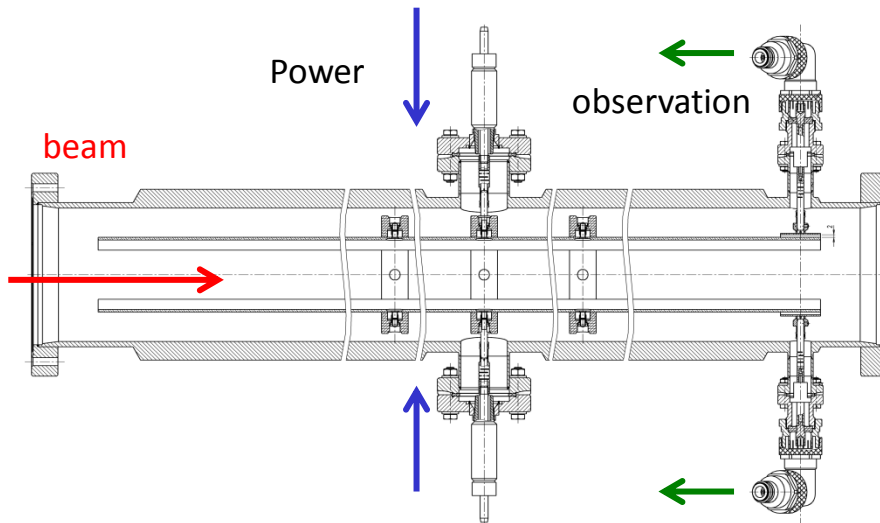

ADT kicker. The beam is kicked by electric field



LHC transverse Feedback (ADT) kickers and amplifiers in tunnel point 4 of LHC, RB44 and RB46

- Kicker length: each kicker 1.5 m
- Max voltage: 10.5 kV
- 2 μm kick to 450 GeV beam
- Gain up to beyond 20 MHz
- 16 kickers,
- 32x30 kW tetrode amplifiers
- Bandwidth up to 20 MHz

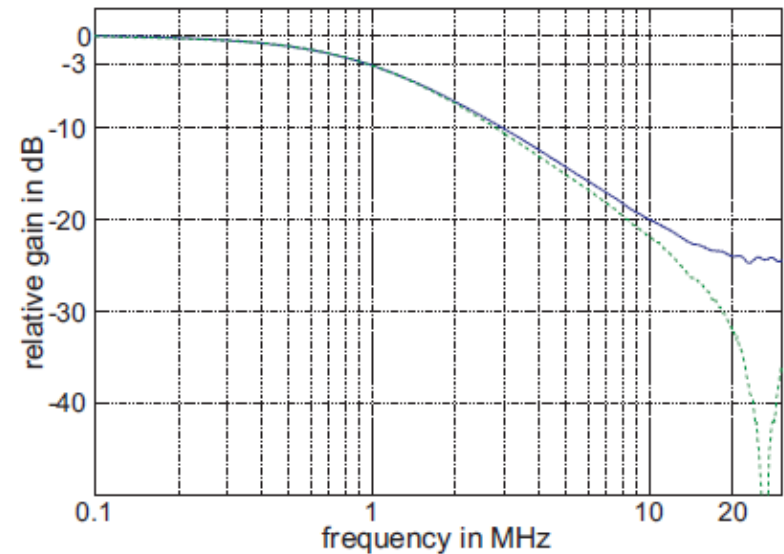

Measured ADT frequency response. Green: bare power amplifier, blue: power amp + kicker.

Built in collaboration with JINR,
Dubna, Russia; E. Gorbachev et al.
LHC Proj. Rept.-1165 CERN (2008)

Instability Growth Rates versus Damping

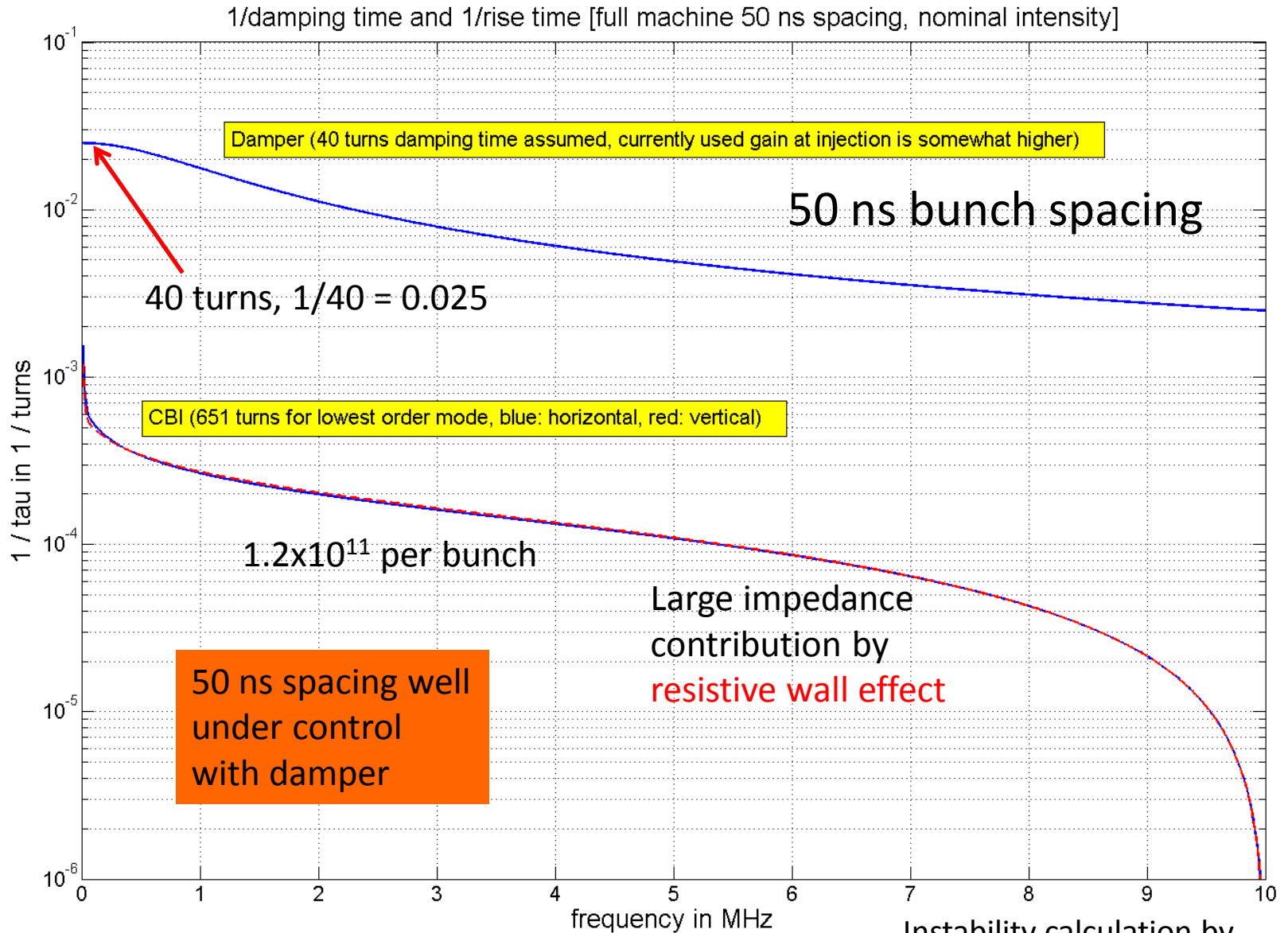

Instability calculation by
N. Mounet (CERN BE-ABP)

Drive Signal Generation



Under ground cavern

- 200 W driver amplifiers (25 MHz BW)
- tetrode amplifier control

EMC

- carefully designed to minimize perturbances by noise
- major EMC issue during commissioning: 8 kHz switching frequency of UPS

Electronics in surface building SR4 for easy access during commissioning

- A/D conversion
- all signal processing and D/A
- computer controls

Overview of ADT Signal Processing

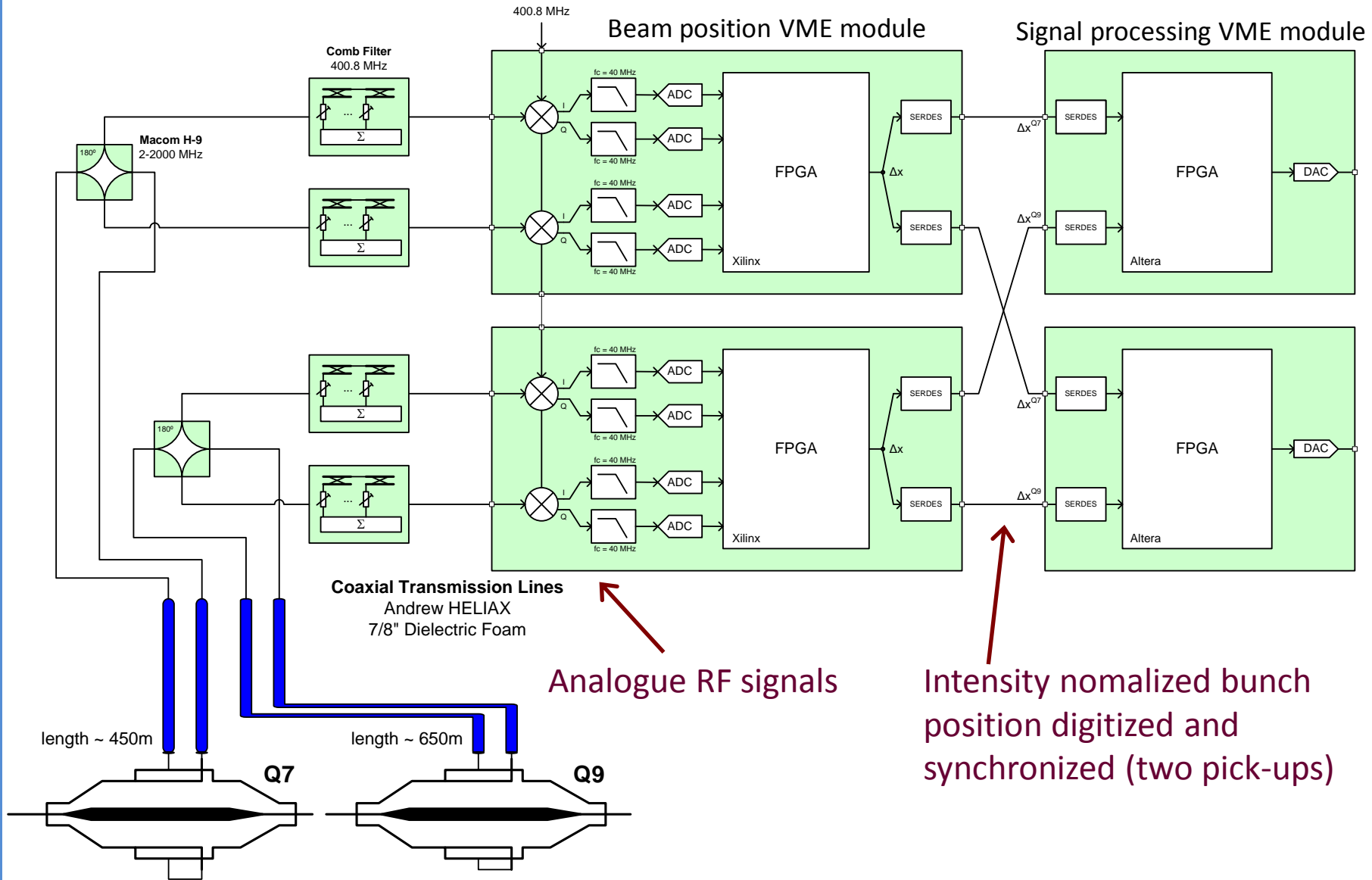

Beam Position Module

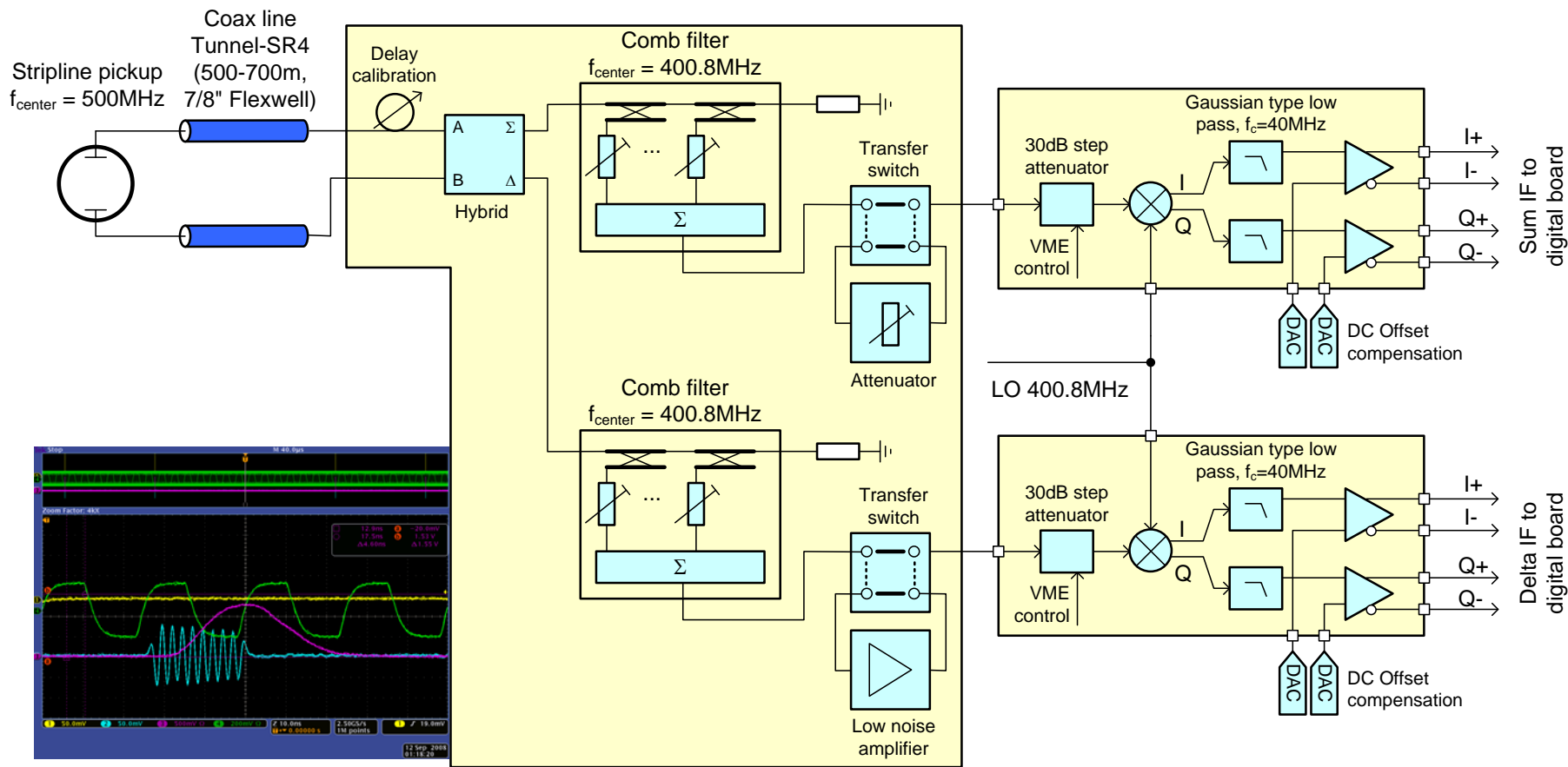

- Low noise amplifier for for good S/N ratio before
- Adaptation of signal levels to beam intensity
- Challenge for multi-bunch operation: keeping reflections under control

ADC / Signal Processing / DAC

- **Beam Position VME board**
 - bunch spacing: 25 ns, 40 MS/s
 - bunch by bunch normalised position
 - 16 bit ADCs
 - 2 μm rms resolution
 - Gbit serial link to transmit data for processing or storage
- **Processing VME board**
 - 80 MHz clock frequency
 - amplitude and phase correction by FIRs
 - adjustment of delay and feedback phase
 - generation of excitation signals
 - 14 bit DAC



LHC Transverse Feedback - Post LS1

Major upgrade in LS1 (2013-2014)

- doubling # of pick-ups
- complete re-cabling of PUs
- new digital hardware
- multiple ADCs and DACs
- reduction of noise
- flexibility for gain control
- instability diagnostics (trigger !)
- tune diagnostics (GPU)

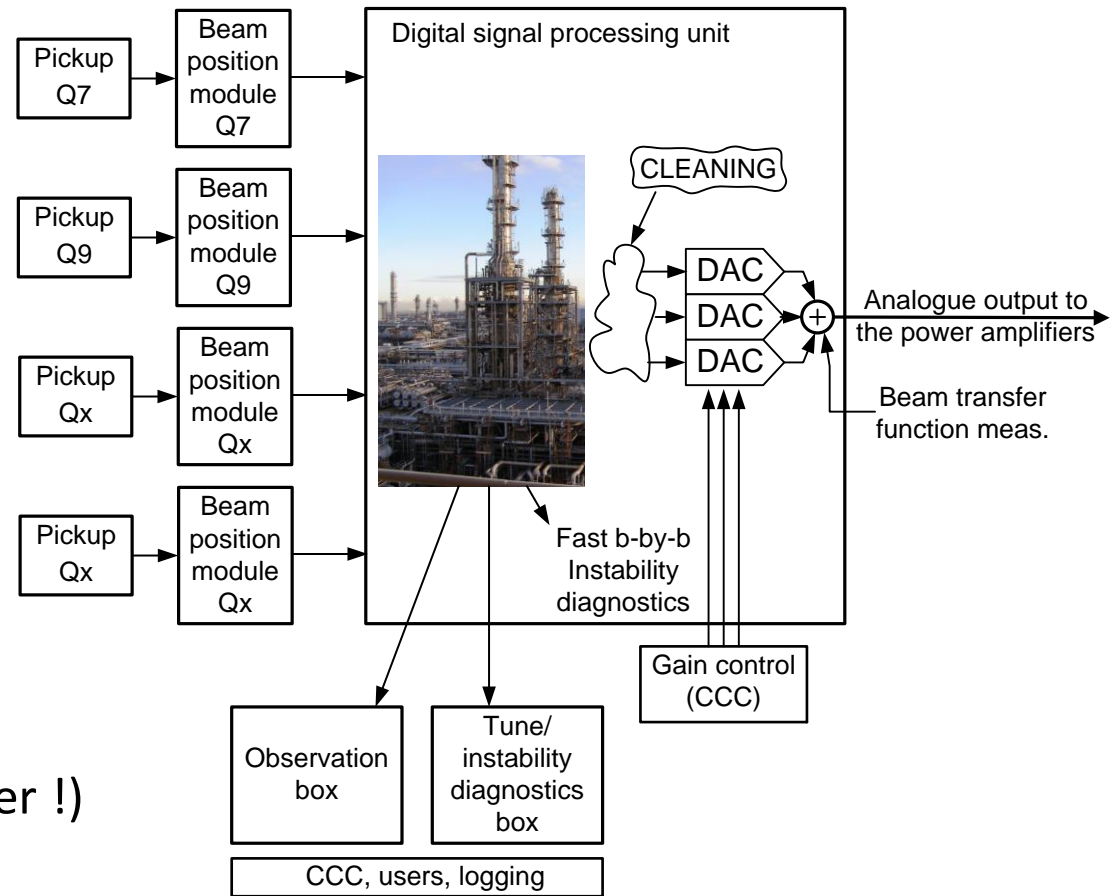

D. Valuch,
CERN BE-RF

TRANSVERSE FEEDBACK KICKER AS AN EXCITER

Abort Gap Cleaning

(Abort Gap Monitor
(Synchrotron Light))

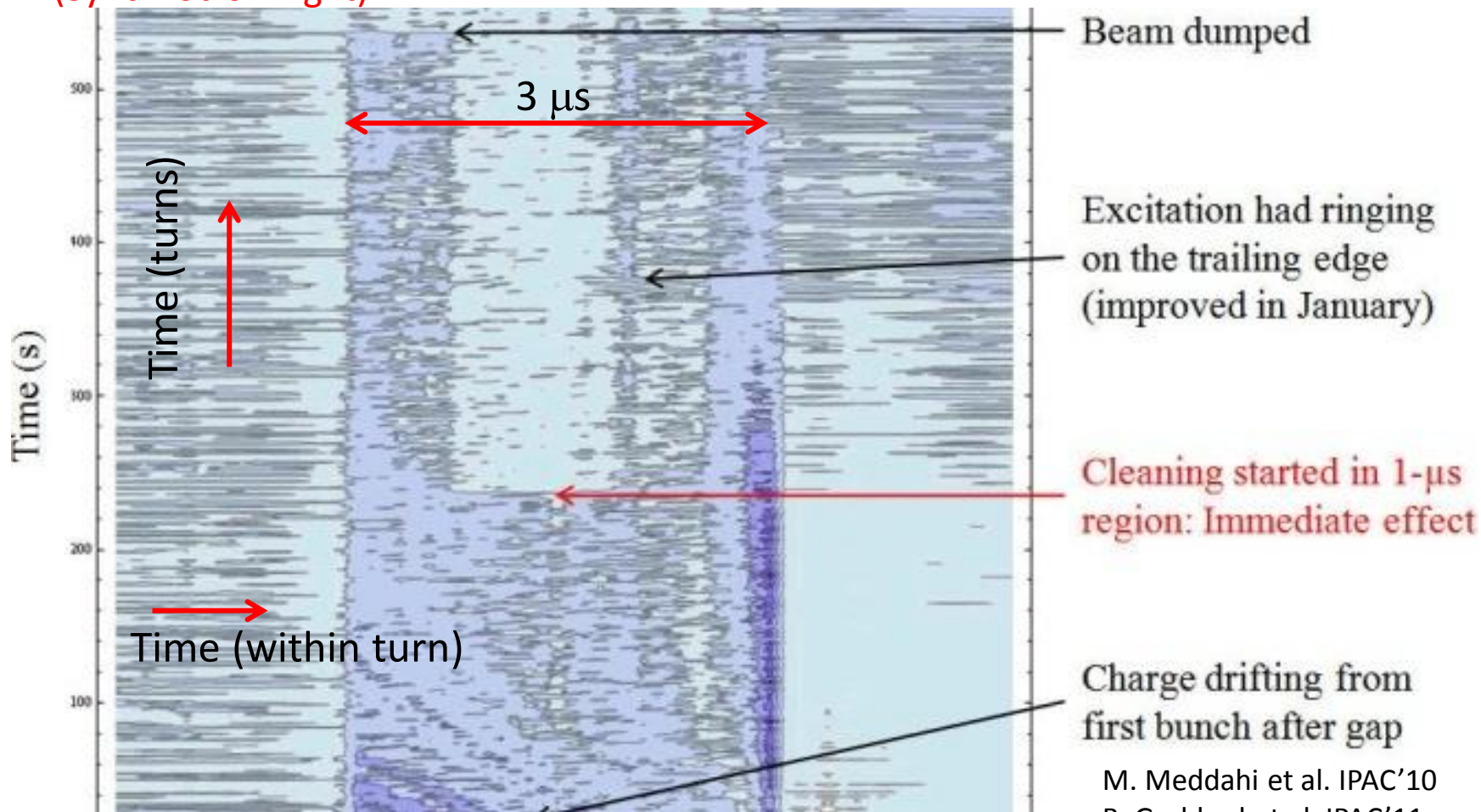

M. Meddahi et al. IPAC'10
B. Goddard et al. IPAC'11
E. Gianfelice-Wendt et al. IPAC'12

Abort gap viewed by abort gap monitor with RF switched off,
Cleaning by ADT (DDS) in V-plane stepping through a range of frequencies
Also used for injection gap cleaning prior to every injection (H-plane)

Selective Transverse Blow-up

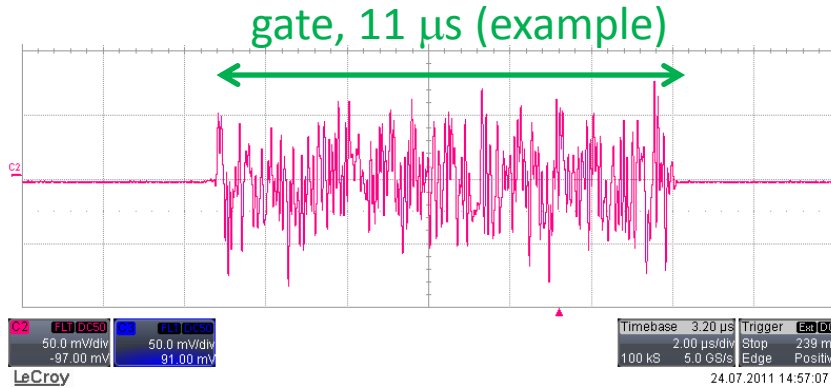

- “White noise” generated on FPGA clocked at 40 MS/s

→ aperture measurements by blow-up loss maps for collimation set-up dynamic aperture

→ any kind of excitation can be gated (also DDS produced narrow band)

Wire scanner measurements (normalized transverse emittance)

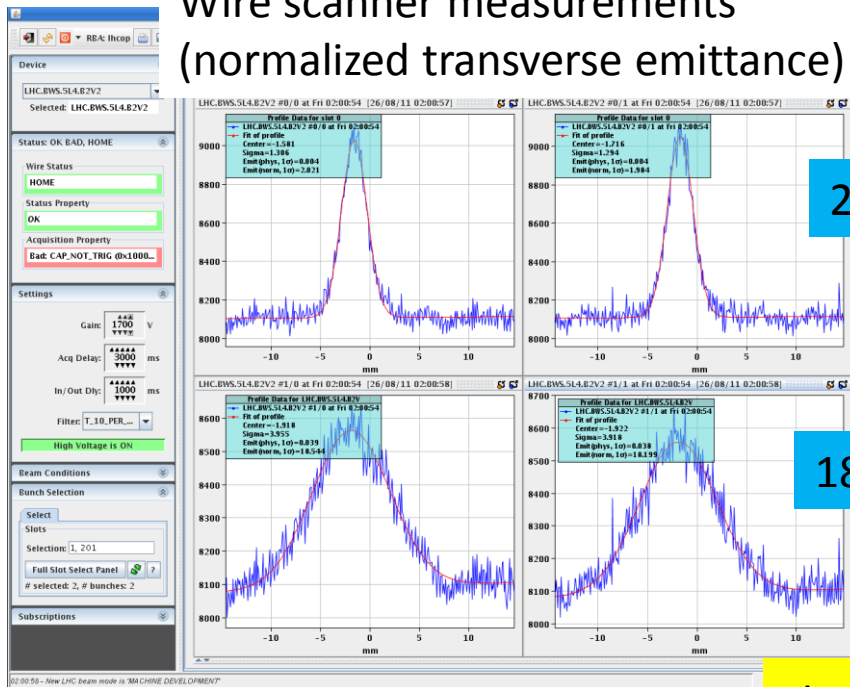

2 μm

18 μm

stops at 18 μm → aperture

- Blow-up functionality very important In a future very large HC (to balance emittance damping by synchrotron radiation damping)

aperture measurement using blow-up with transverse damper

Loss Maps:
V. J. Moens, S. Redaelli et al. MOPWO050

Fast Losses with ADT Simulating “UFO” Type Losses for Quench Test

evolution of beam oscillation amplitude

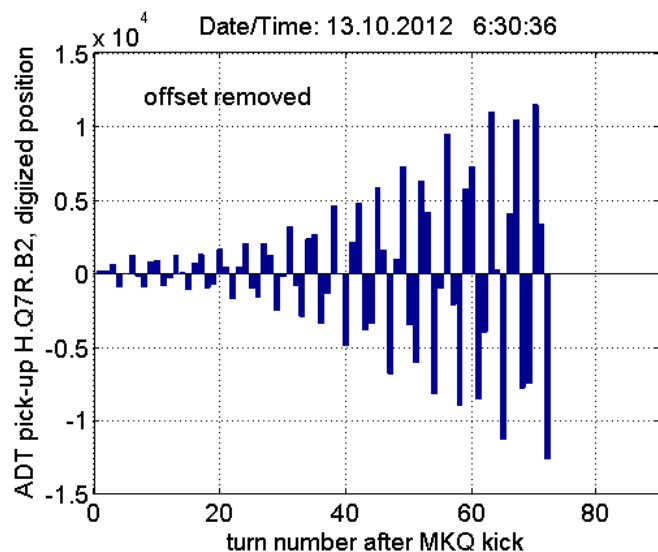

Transverse Feedback was used as exciter in three quench tests carried out in February 2013

Fast losses (BLM signal)

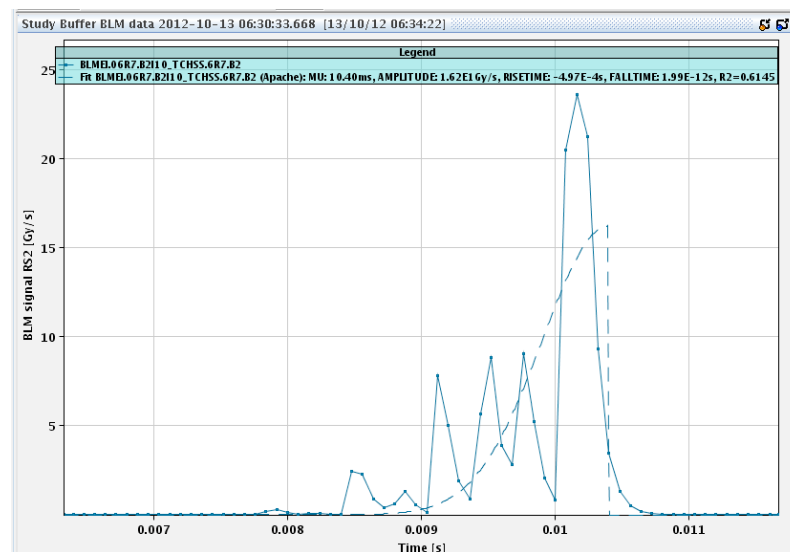

1 ms

M. Sapinski et al.
WEPME044 and THEA045
(Fast Losses and Quench Tests)

OPERATIONAL EXPERIENCE WITH TRANSVERSE DAMPER IN LHC

Injection Oscillation Logging and Analysis

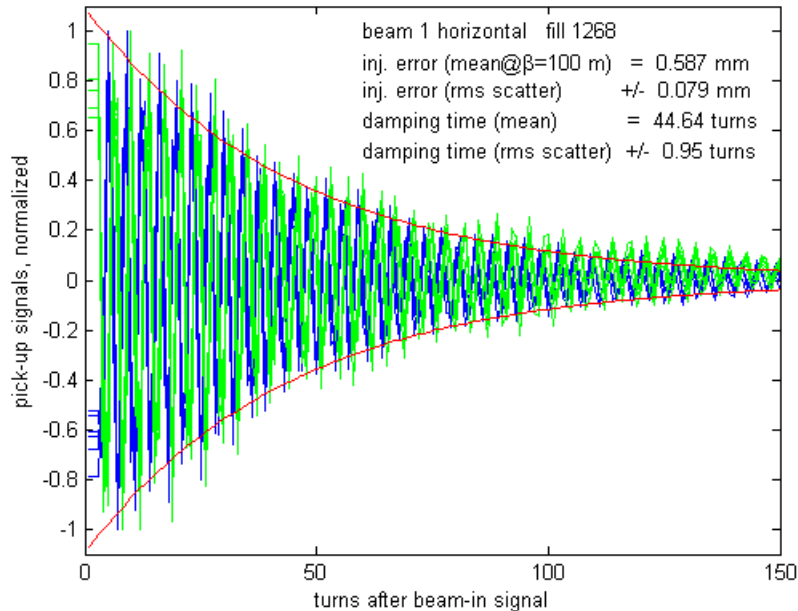

Injection damping fill 1268 (August 9, 2010)
horizontal plane beam 1

- All injection oscillation data of the first bunch of every batch logged since Summer 2010
- Can retrieve performance at injection from logging
- Data also logged for post mortem when beam is dumped
- Memory to log 73 turns x 3564 possible bunch positions (25 ns spacing) for observation

Automated Fill Analysis: Damping Time

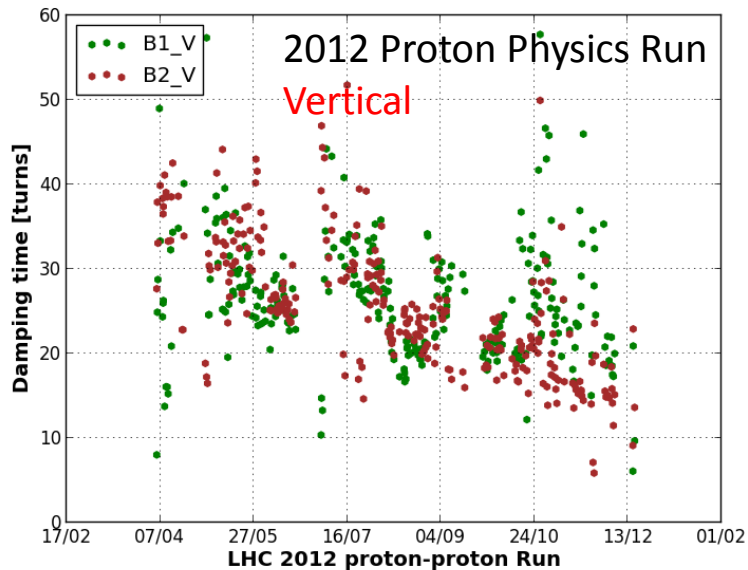
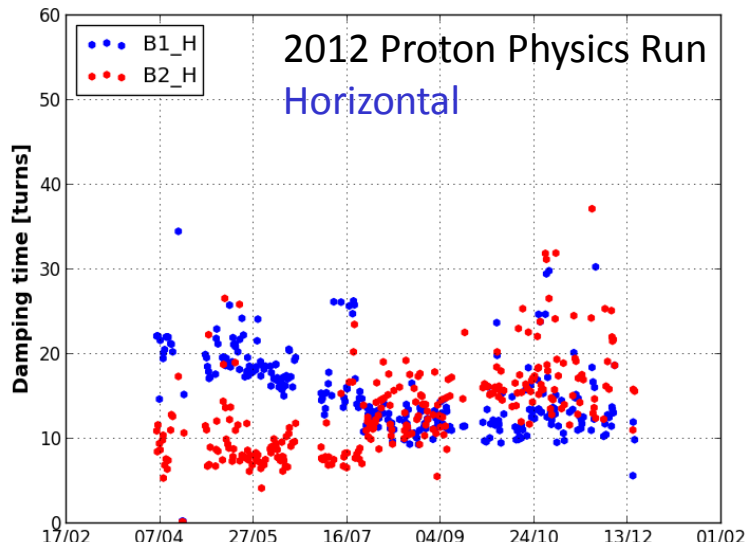

- Injection oscillations damping of **first bunch in a train systematically logged**
- **Fill analysis tool** computes damping time and tune for every injected batch and fill
- Data **quality check** challenging
- Variations over time in part due to chromaticity settings (V-plane !)
- **Difference H/V**: large V inj. error → first bunch on edge of kicker pulse

A. Macpherson
CERN BE-OP & BE-RF

Automated Fill Analysis: Damping Time

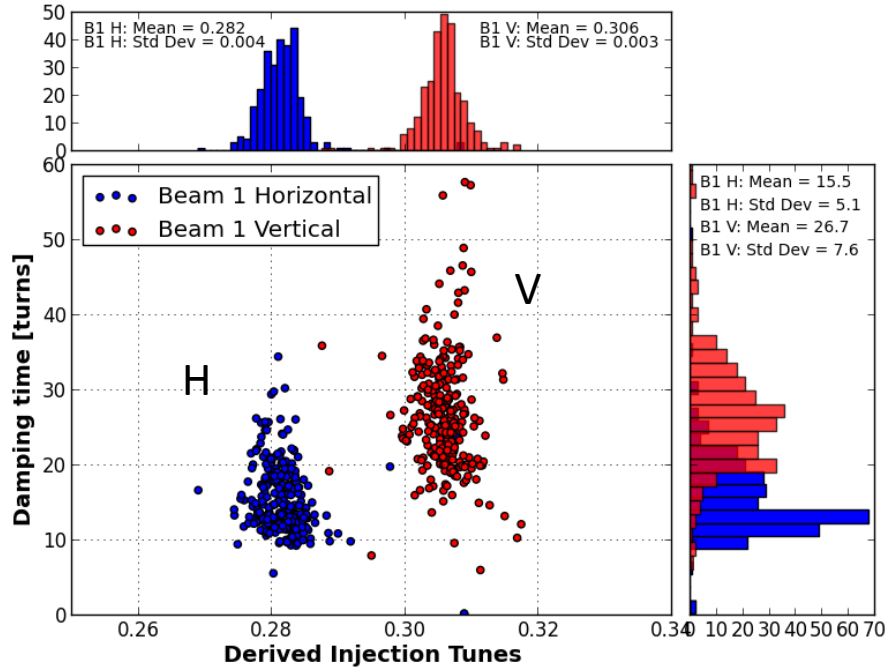

Beam 1

H: 16 turns

V: 27 turns

Beam 2

H: 13 turns

V: 26 turns

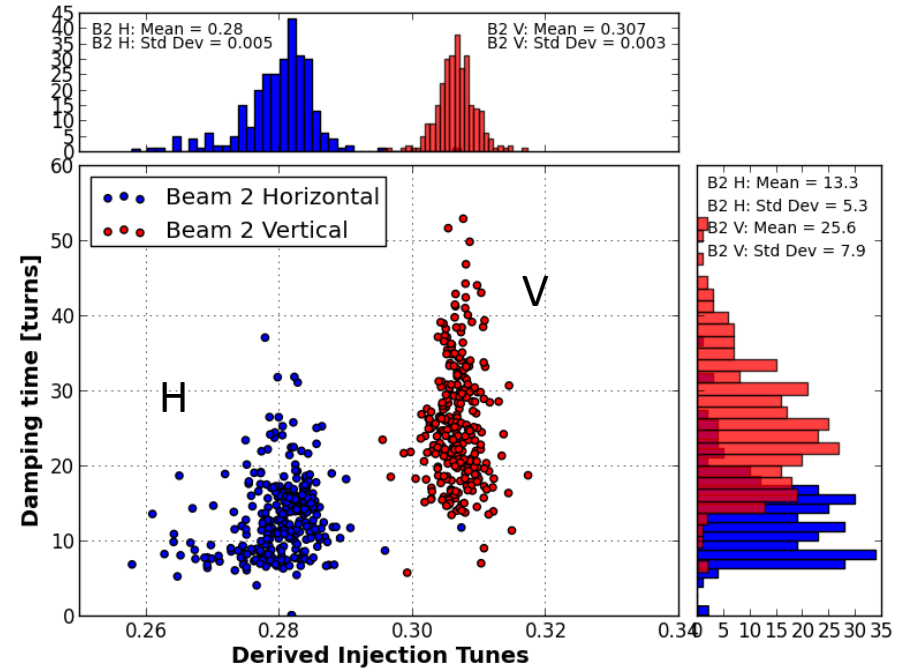

A. Macpherson

CERN BE-OP & BE-RF

Performance with Bunch Trains in LHC 2012

50 ns bunch spacing
standard + hold
144 bunches (4x36)

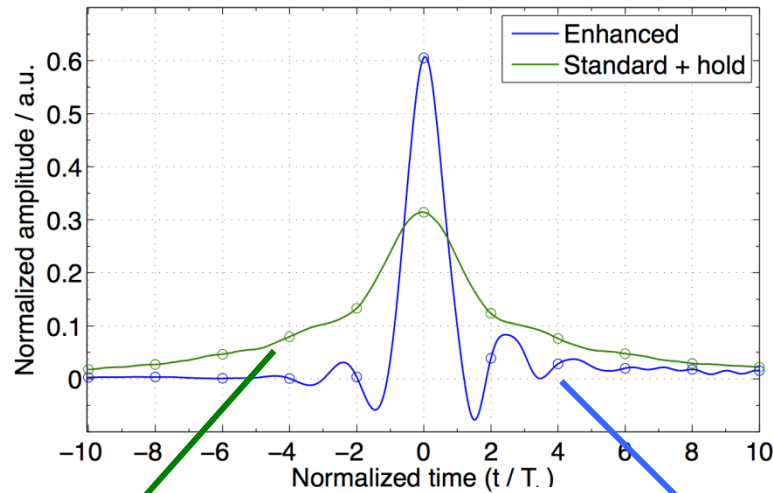

25 ns bunch spacing
enhanced bandwidth
144 bunches (2x72)

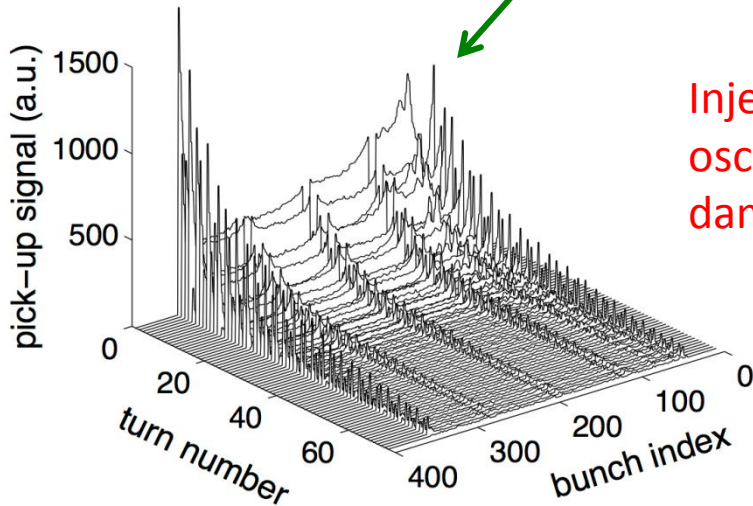

Injection
oscillation
damping

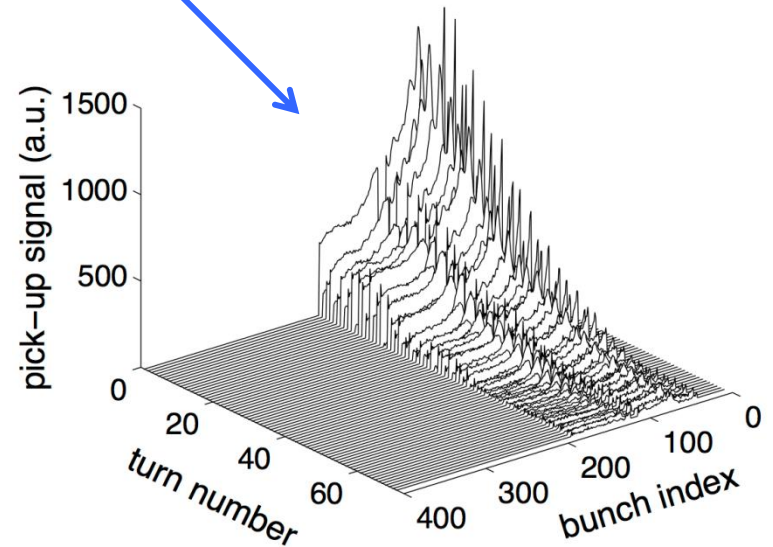

Operation Through Cycle

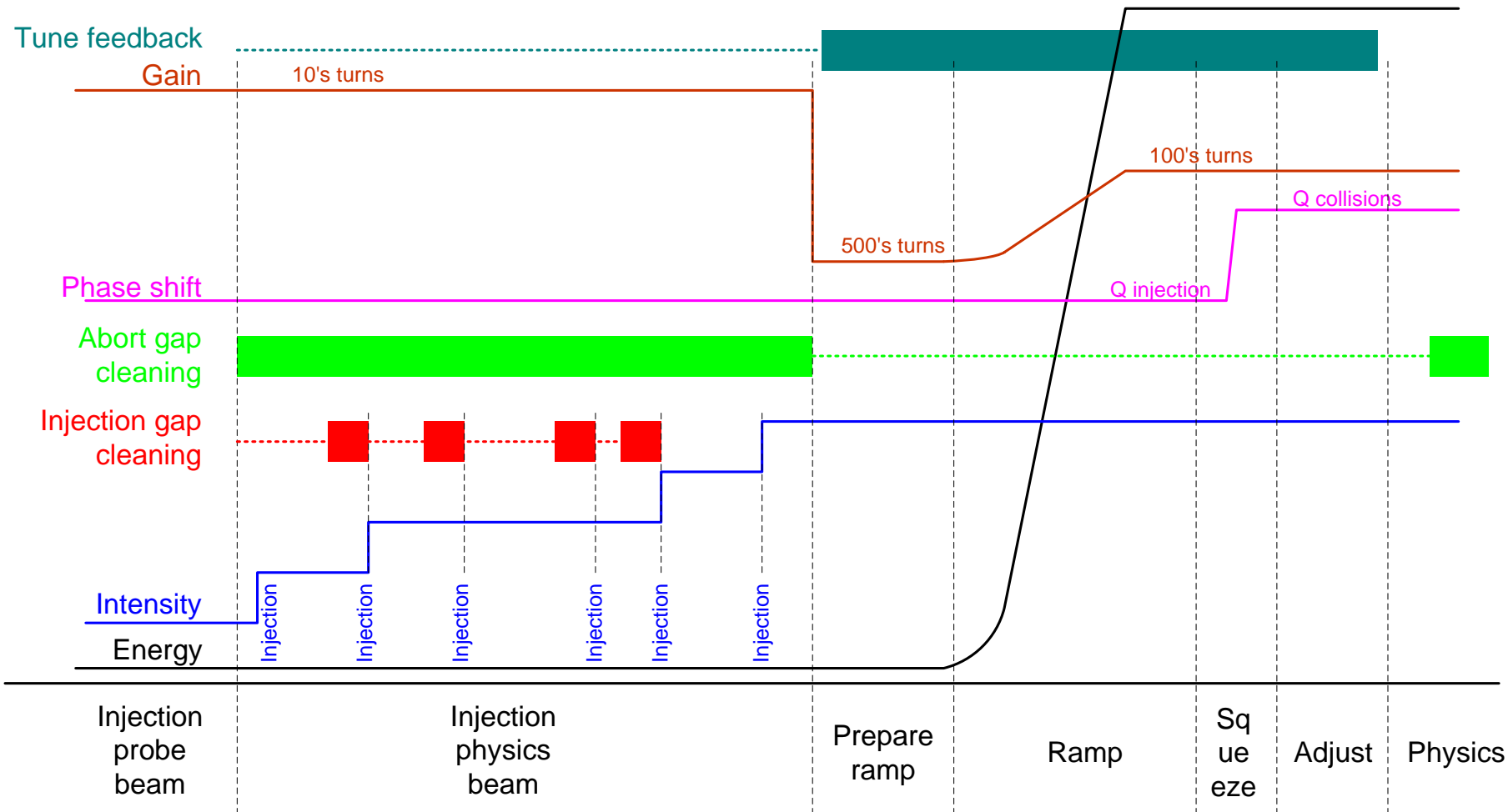

TRANSVERSE FEEDBACK AND TUNE DIAGNOSTICS

Impact on Tune Measurement System (LHC)

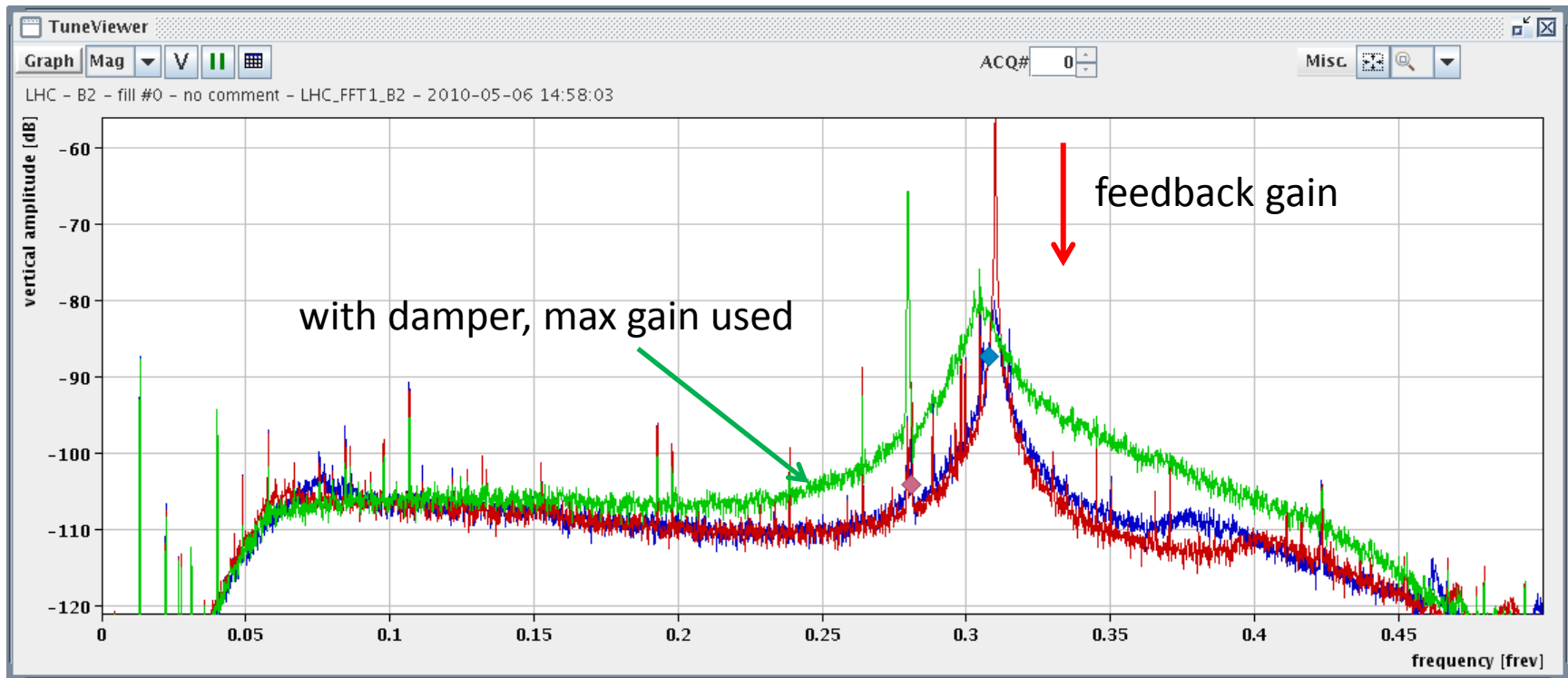

R. Steinhagen
PAC'11, N.Y.

- less broadening with lower gain
- reduction of tune peak, i.e. residual oscillations by more than 20 dB

→ solution deployed in 2012: ADT **gain modulation within turn** and **gated BBQ**
6 bunches are used for the Tune Measurement, these have low ADT gain

Closed Loop Transfer Function

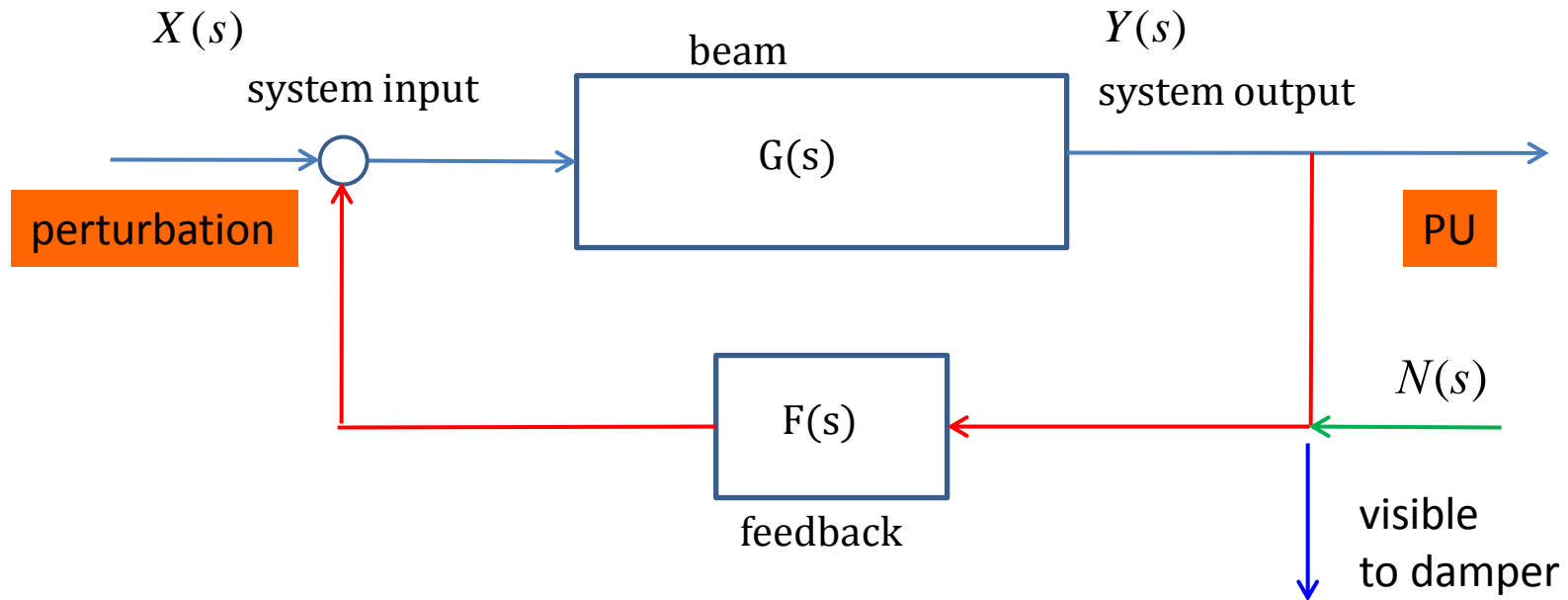

open loop

$$Y(s) = G(s)F(s)N(s)$$

output of closed loop

$$Y(s) = -G(s)F(s)N(s) - G(s)F(s)Y(s)$$

closed loop transfer function

$$G_{\text{CL},N}(s) = \frac{Y(s)}{N(s)} = \frac{-G(s)F(s)}{1 + G(s)F(s)}$$

See also formalism with z-transform treatment: [C.-Y. Yao et al. WEPME56 \(Argonne NL\)](#)

Tune measurement from in-loop signal: [C. H. Kuo, IPAC'11, pp. 514-516](#)

Spectra with feedback on (LHC)

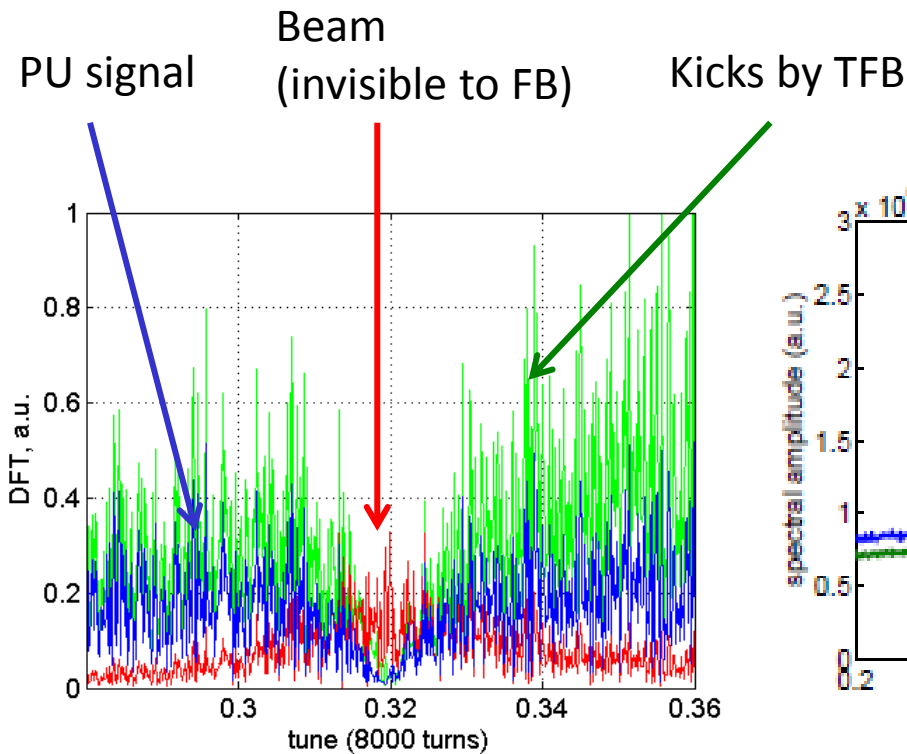

Simulation:
Single bunch 8000 turns

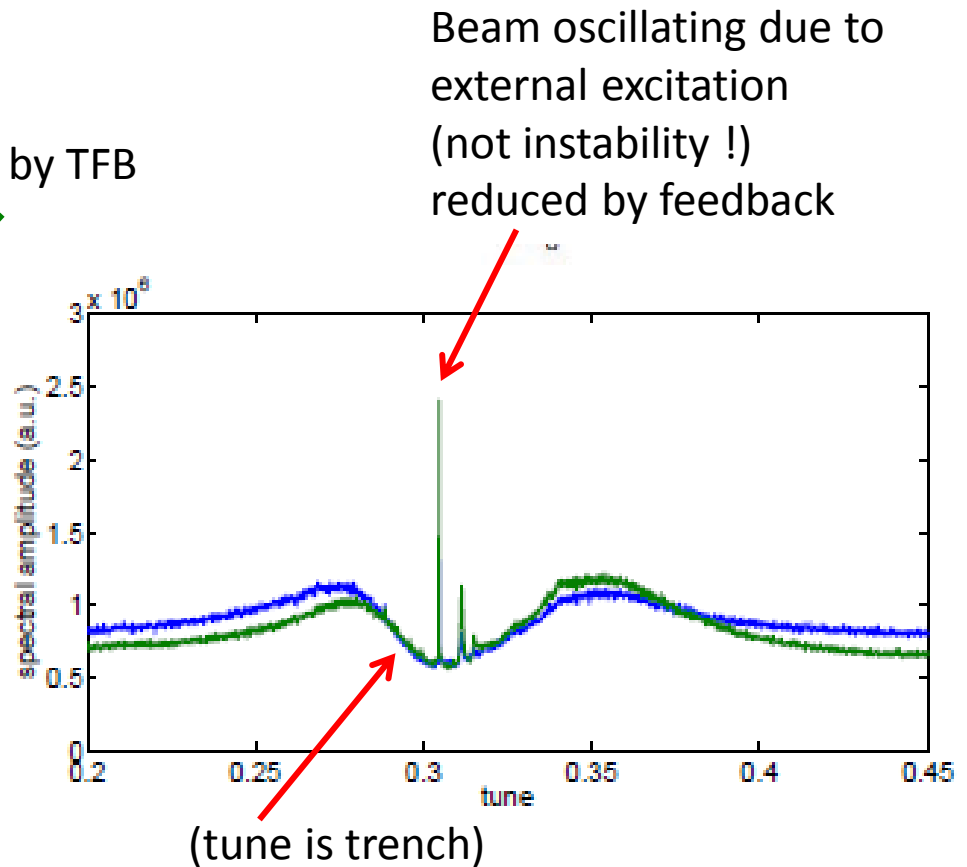

Measurement from a single bunch, two pick-ups, spectra averaged over 45 minutes (2010 data, V plane)

W. Hofle, V. Lebedev et al. IPAC'11

Tune Measurement with ADT (LHC)

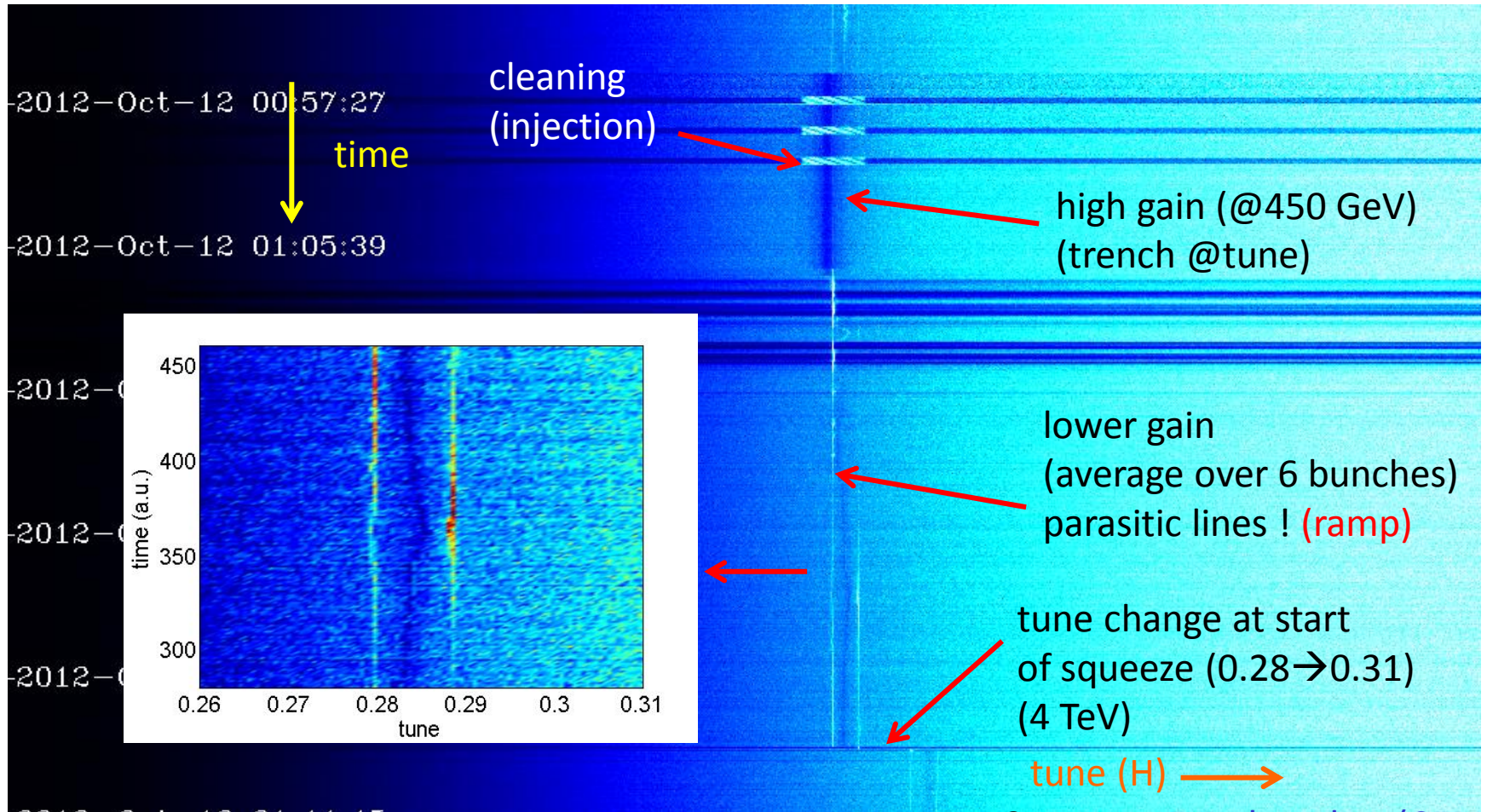

Based on recording of 6 bunches (horizontal plane)

(also considering and tested excitation by short burst gated on 6 bunches)

Courtesy: F. Dubouchet (CERN)

MITIGATION OF TRANSVERSE INTRA BUNCH MOTION BY FEEDBACK

Intra Bunch Transverse Feedback

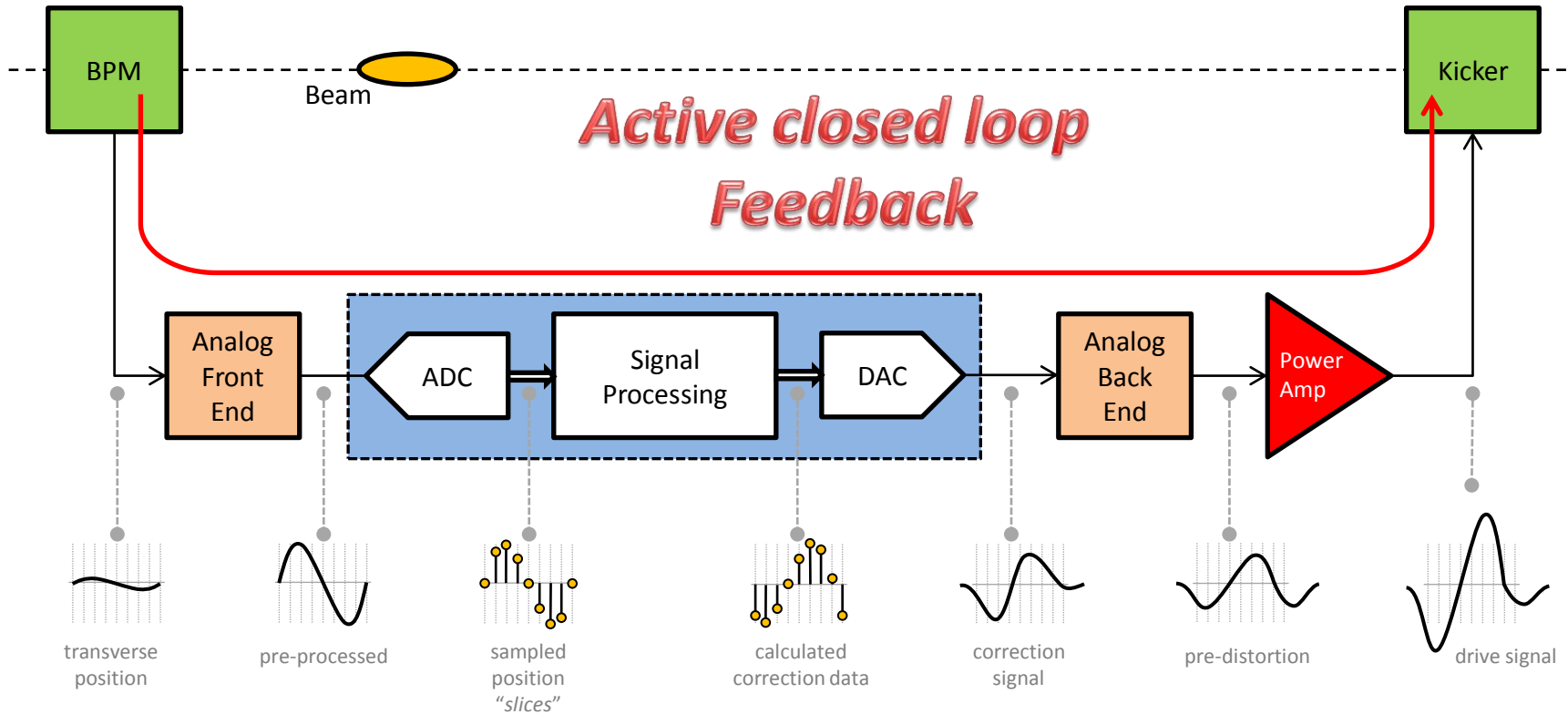

CERN PS Transverse Feedback

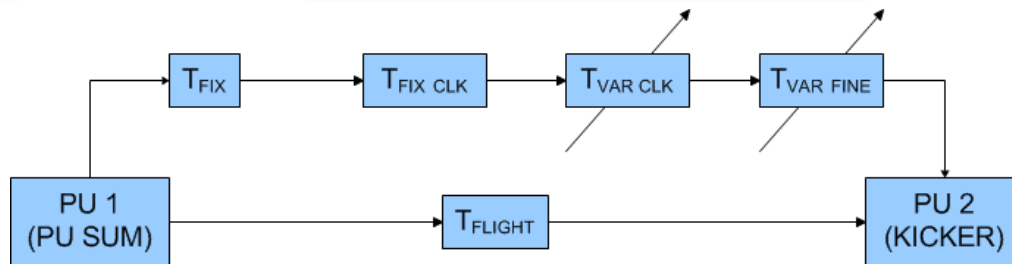
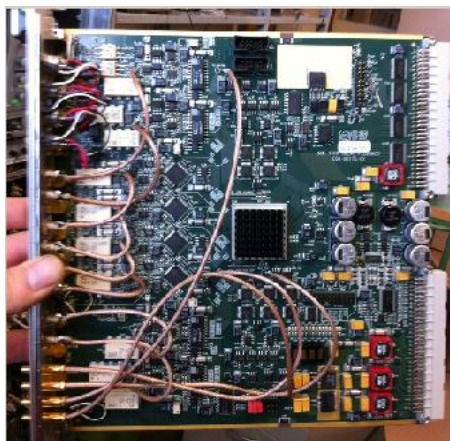
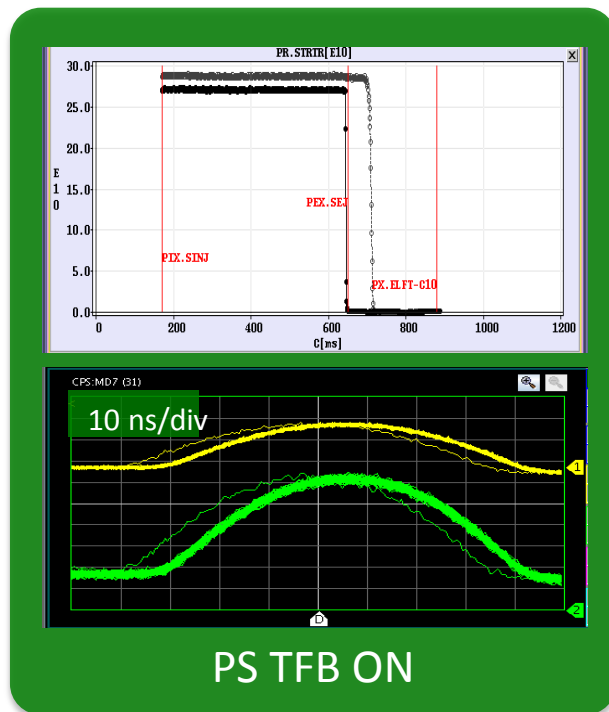
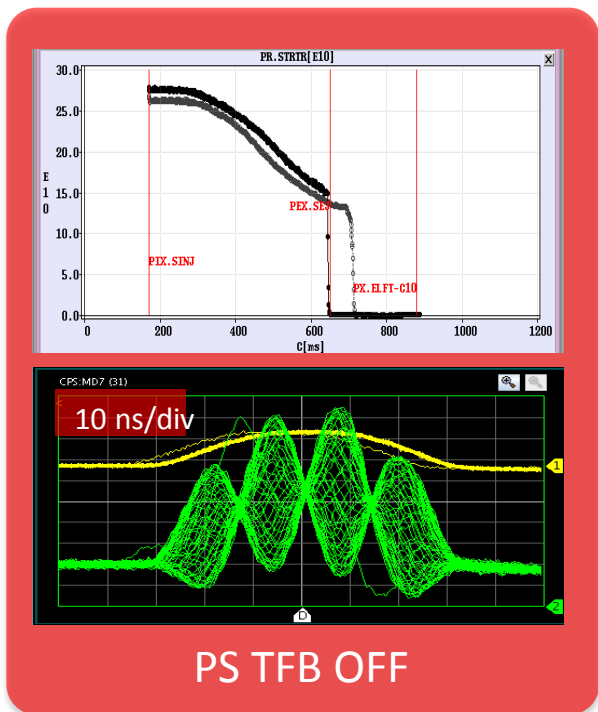

1.4 GeV → 26 GeV

Challenge:

Time of Flight Compensation
Fully digital implementation

A. Blas et al. WEPME011
D. Perrelet (CERN BE-RF)

SPS High Bandwidth Damper Project

- Feedback Project addresses limitation in the SPS in intensity due to **E-Cloud Instability (ECI)** and **Transverse Mode Coupling Instability (TMCI)**
- Recent Simulations with Head Tail Code confirm feasibility
- **SPS is test bed** for deployment of such a system in other accelerators (e.g. LHC)

Mode Spectra without feedback

ECI (limitation at 25 ns spacing)

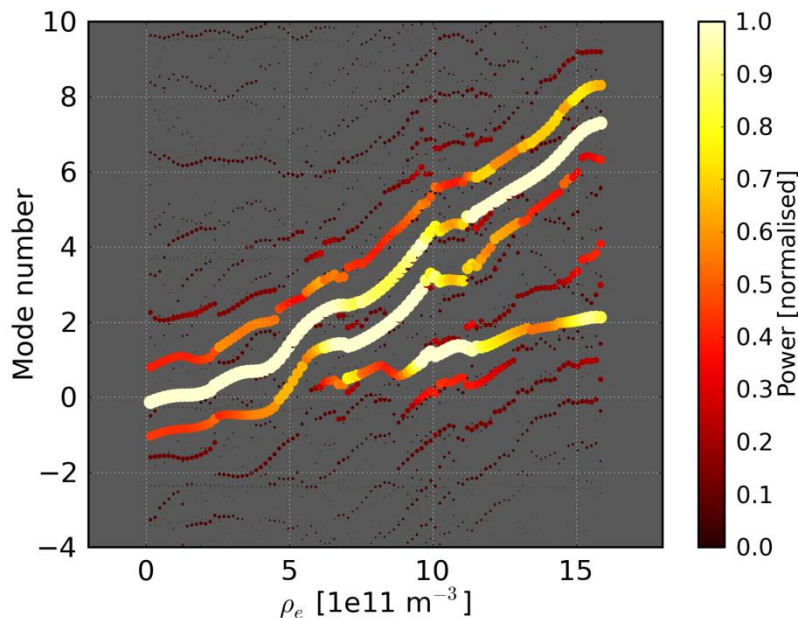

CERN SPS

TMCI (single bunch intensity limitation)

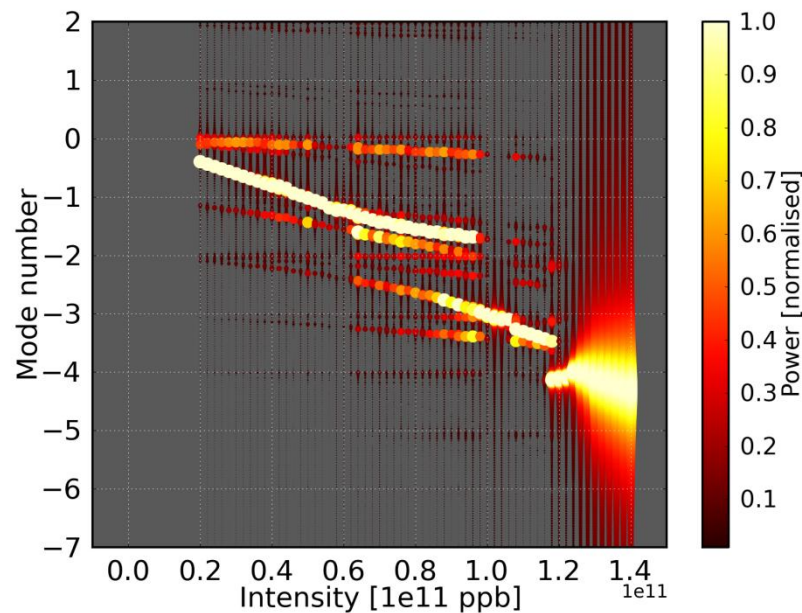

Courtesy: K. Li, CERN

Simulations with Feedback

K. Li et al., WEPME042

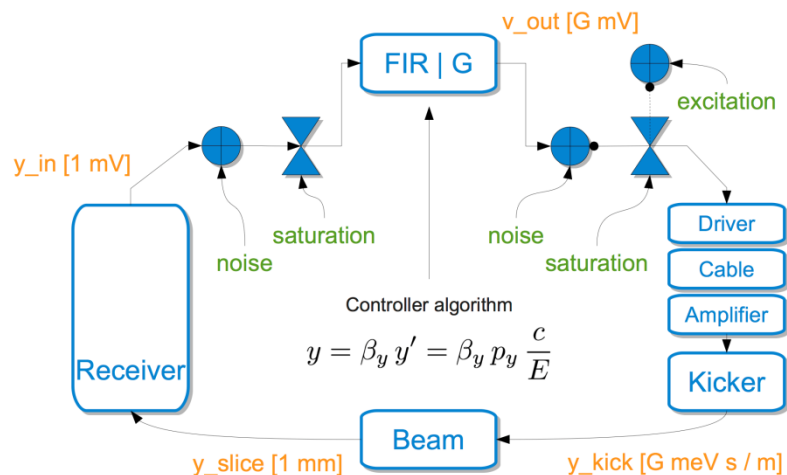

Bandwidth need at **SPS injection 450 GeV/c** from simulation (2.7 ns bunch length)

- ECI: 500 MHz
- TMCI: 200 MHz

CERN Headtail Code

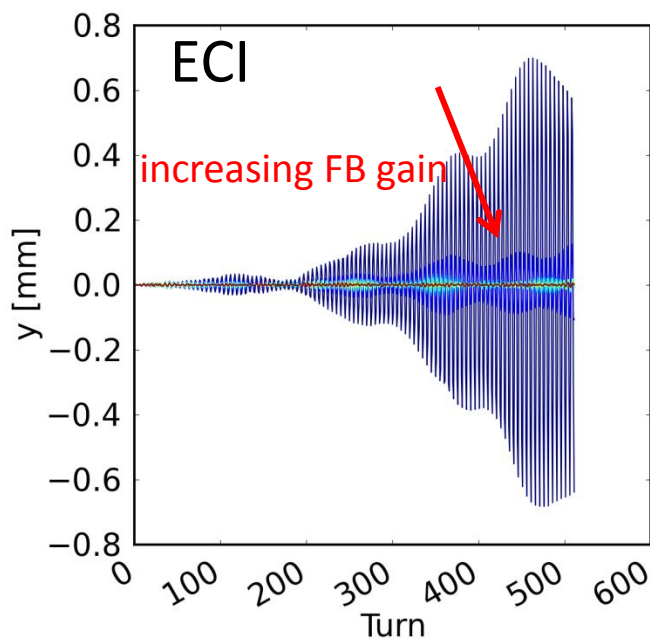

CERN SPS

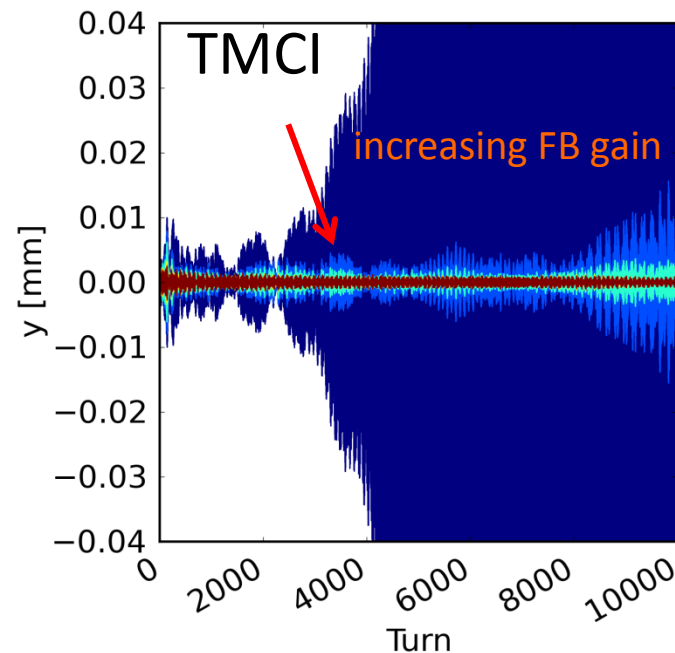

Hardware Development for the SPS feedback

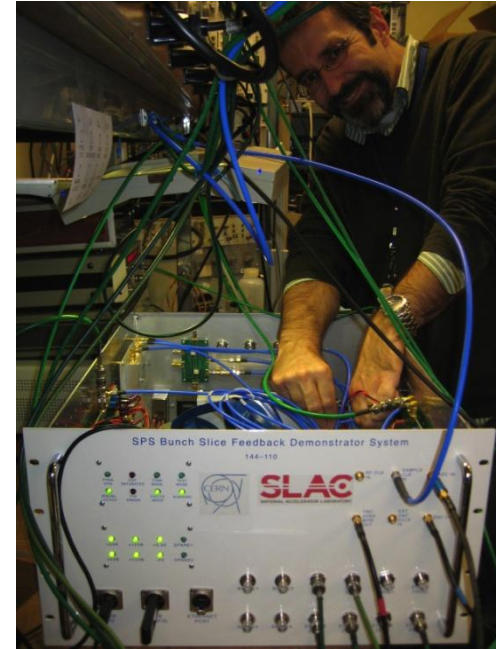
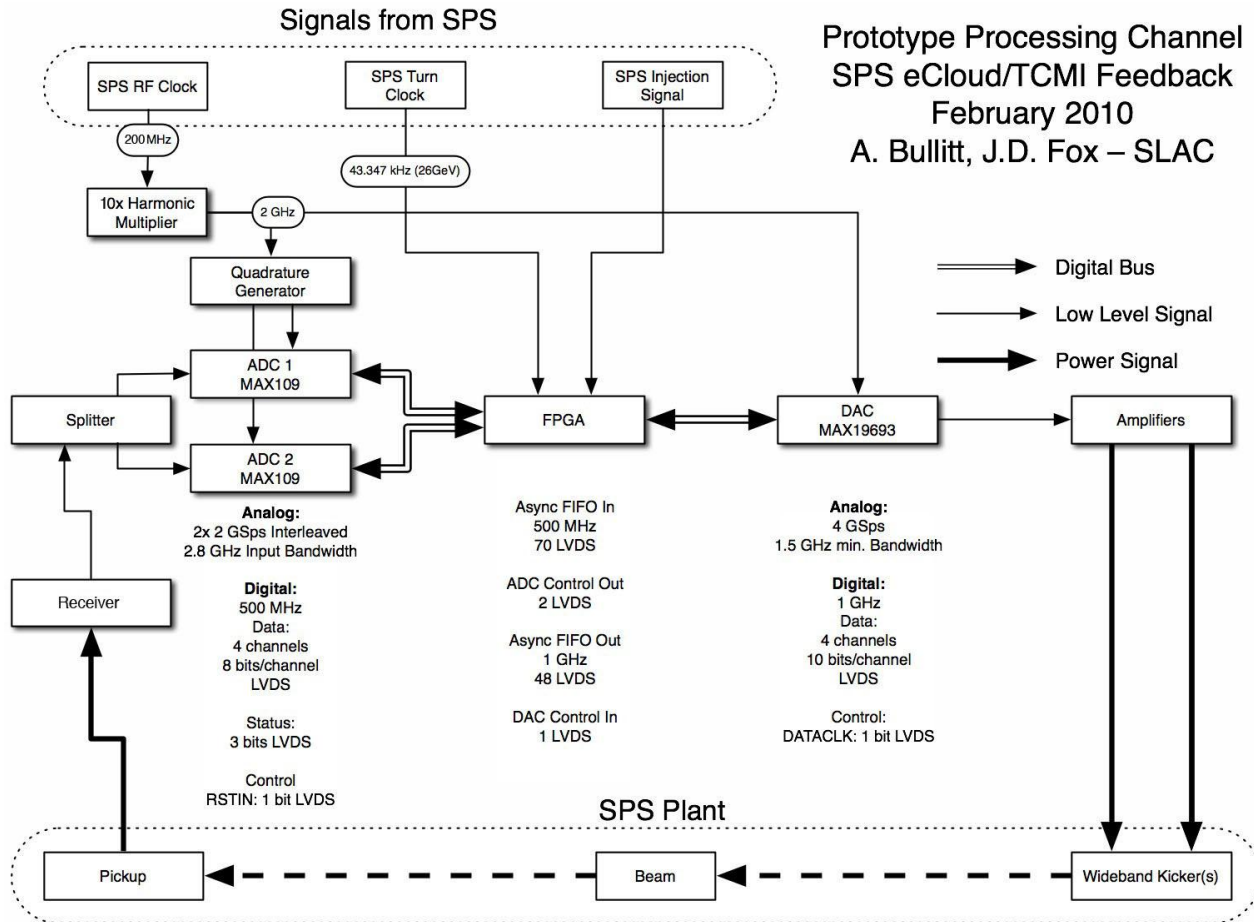

- 4 GS/s sampling rate
- 16 5-tap FIR for single bunch control

J. Dusatko et al. (SLAC)

WEPME061

CERN SPS

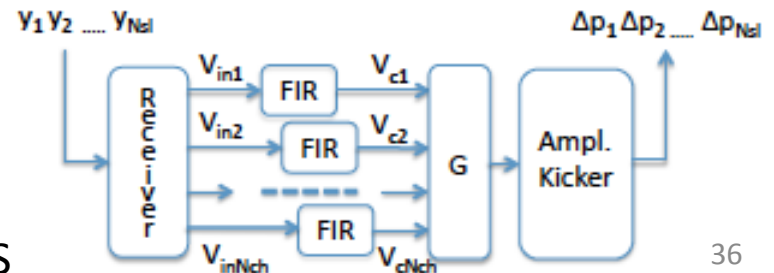

Single Bunch instability control with SPS HBTFB

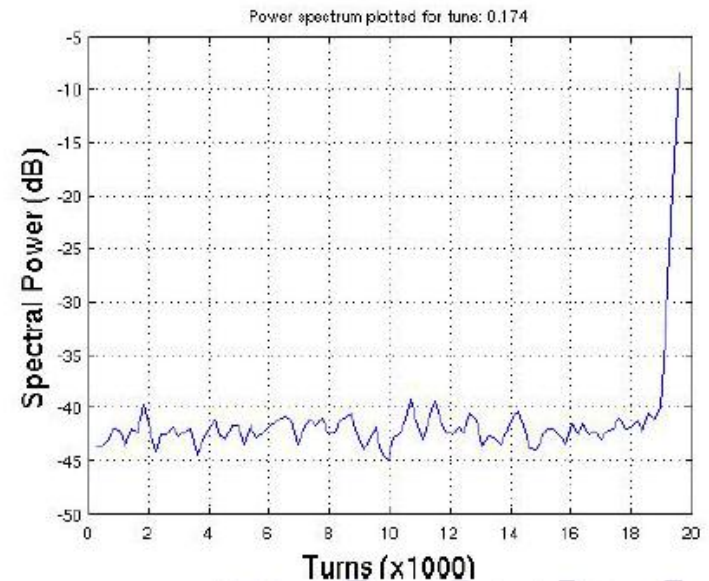
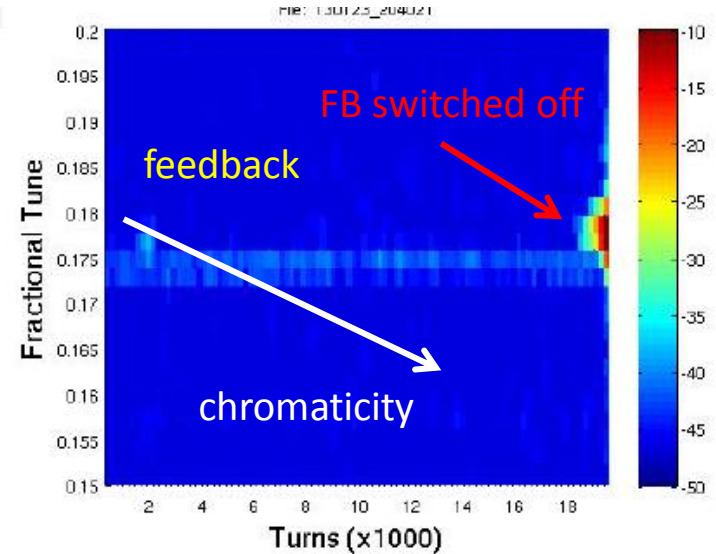
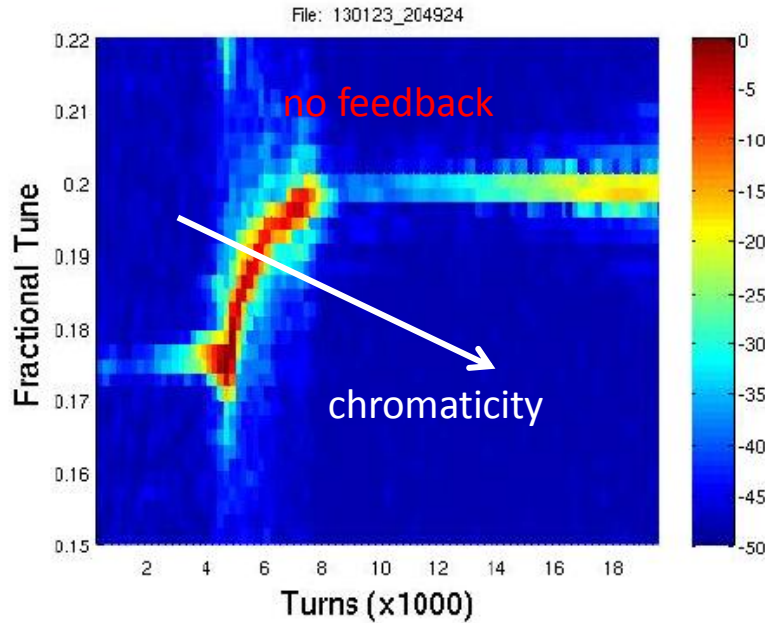

- Spectrograms of bunch motion, nominal tune 0.175
- after chromaticity ramp at turn 4k, bunch begins to lose charge and gets tune shift.
- Feedback OFF -Bunch is unstable in mode zero (barycentric).
- Feedback ON -Feedback is switched off at turn 18K, beam then is unstable

Beam Response in Closed Loop

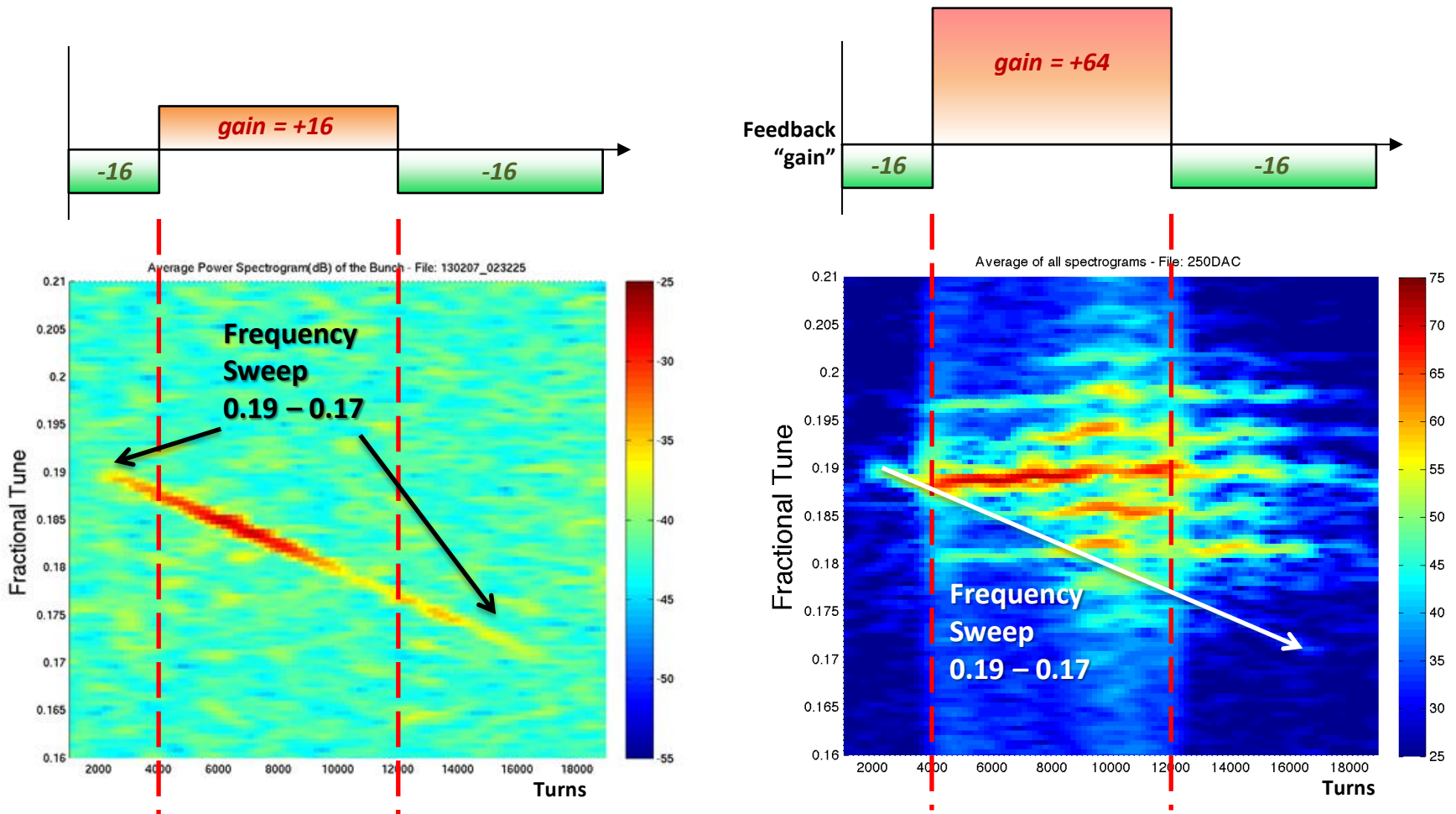

- Note the **different response** of the beam for **different positive feedback gains**.
- **Many modes** get excited with **higher gain** in positive feedback.

2012-2013 experimental results:
J. D. Fox et al. (SLAC), WEPME060

Kicker Design for SPS Feedback

Need for high Bandwidth requires new kicker for the SPS:

- Inspired by Stochastic Cooling Systems \rightarrow Faltin type kicker considered (strip-line with slotted shield to beam pipe)

L. Faltin, Nucl. Instrum. Methods **148** (1978) pp. 449.

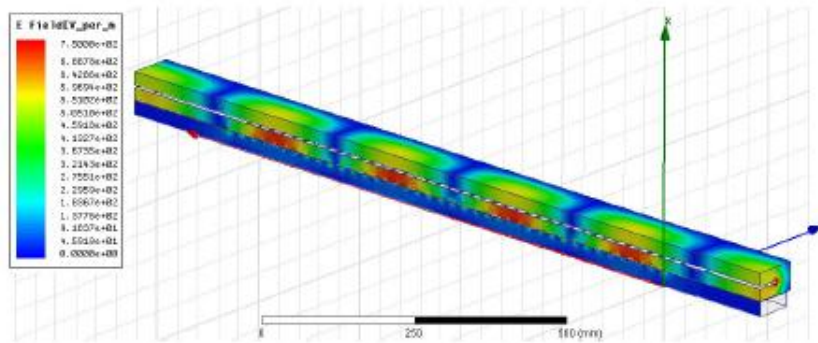
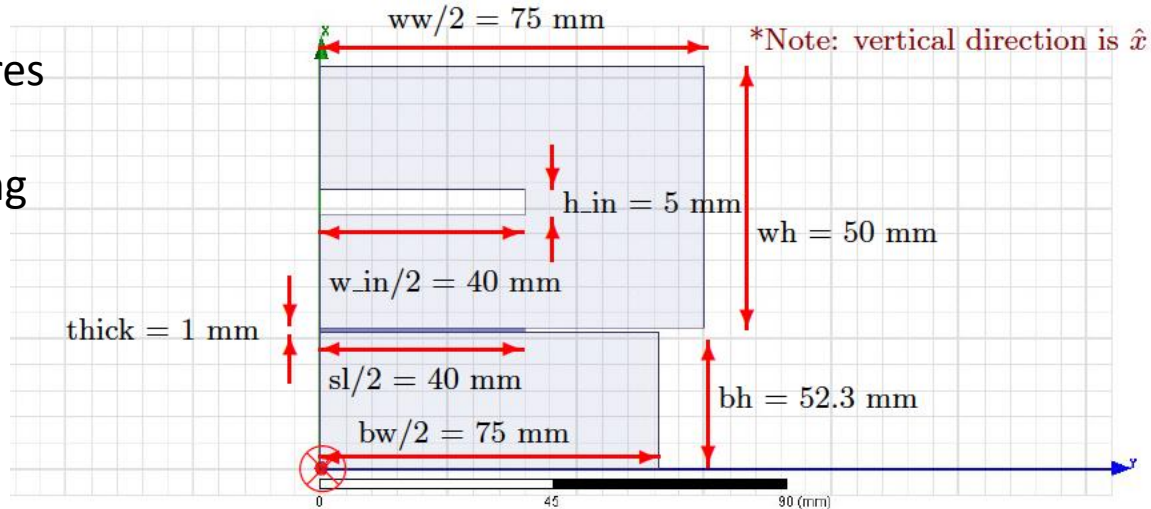

J. Cesaratto et al. (SLAC)
WEPME061

CERN SPS

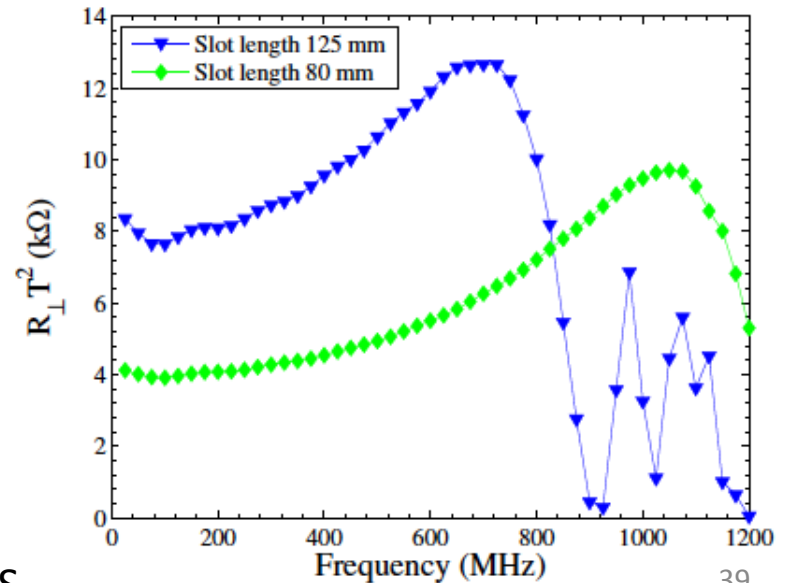

Conclusions

- **Advances in Technology for ADCs and DACs** permit today the design of digital transverse feedback electronics for Hadron Colliders thanks to a high number of bits, **successful example is LHC**
- Transverse feedback essential for **beam stability and emittance preservation used in LHC since 2010 with colliding beams**
- Interferences with tune measurement system promotes use of **in-loop feedback signal for tune analysis** as pioneered also in various electron machines; large number of bunches, need for on-line averaging a challenge
- Further improvement in S/N desirable, **multiple PU, multiple ADCs** an interesting option, also pursued at different labs, good **analog front-end** key
- **Intra-bunch feedbacks** work well for long (10's ns long bunches in proton machines), **high speed ADCs/DACs permit extension to short bunches** (ns range with GS/s) → **new wideband feedback system** is being pioneered for **CERN SPS**, potential future use also in colliders such as LHC
- **Major applications** of transverse feedbacks for purposes of **beam excitation**

Thank you for your attention

SPS High Bandwidth Transverse Feedback Selected Bibliography 2009-2013

- [1] J. R. Thompson et al., PAC'09, (2009), pp. 4713-4715.
- [2] J. D. Fox et al., PAC'09, (2009), pp. 4135-4137.
- [3] J.-L. Vay et al., IPAC'10, (2010), pp. 2438-2440.
- [4] C. Rivetta et al., PAC'11, (2011), pp. 1621-1623.
- [5] R. Secondo et al., IPAC'11, (2011), pp. 1773-1775.
- [6] M. Pivi et al., IPAC'12, (2012), pp. 3147-3149.
- [7] J. M. Cesaratto et al., IPAC'12, (2012), pp. 112-114.
- [8] K. Li et al., WEPME042, these proceedings.
- [9] J. Dusatko et al., WEPME059, these proceedings.
- [10] J. D. Fox et al., WEPME60, these proceedings.
- [11] J. M. Cesaratto et al. WEPME61, these proceedings.

Work presented on the
CERN SPS High Bandwidth Transverse Feedback
is a collaborative effort supported by the US LARP Program

J. D. Fox, J. Cesaratto, J. Dusatko, J. Olsen, M. Pivi, K. Pollock,
C. Rivetta, O. Turgut, S. Johnston (SLAC)
S. De Santis, H. Qian, Z. Paret (LBL)

M. Tobiyama (KEK)

D. Alesini, A. Drago, S. Gallo, F. Marcellini, M. Zobov
(LNF-INFN, Frascati)

G. Arduini, H. Bartosik, W. Hofle, G. Iadarola, G. Kotzian, K. Li,
G. Rumolo, B. Salvant, U. Wehrle, C. Zannini (CERN)

ADDITIONAL SLIDES

Impulse Response – Linearization of Phase

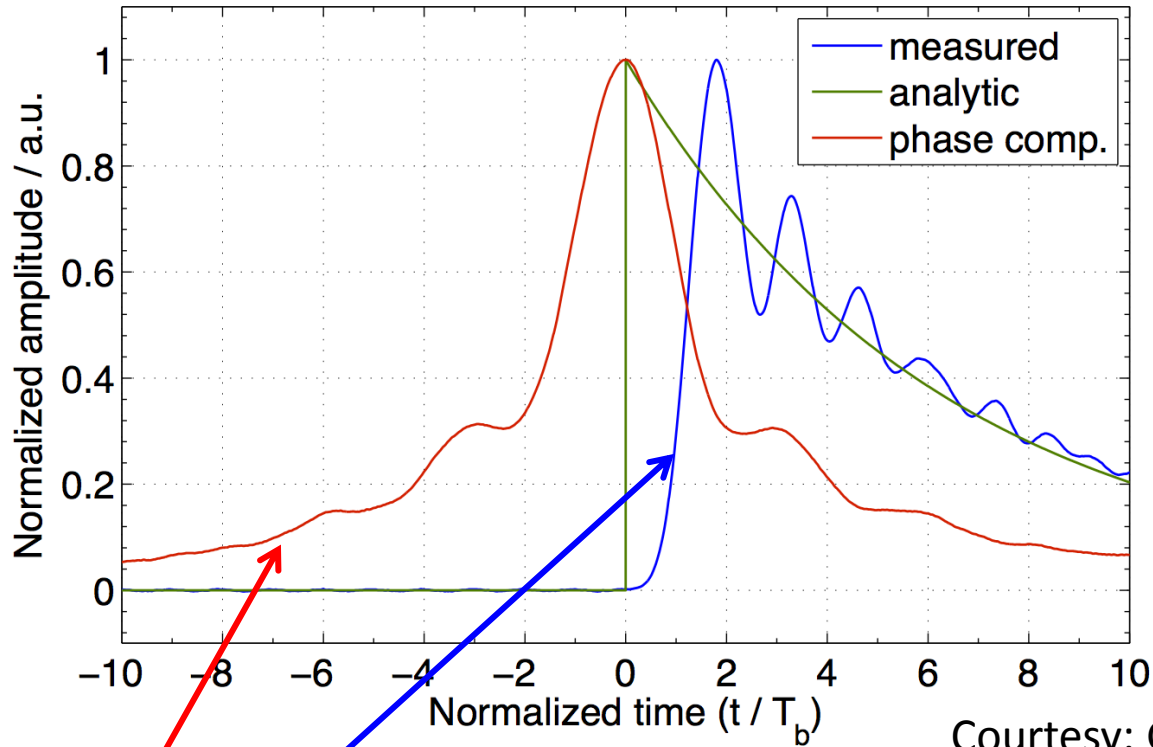

Courtesy: G. Kotzian

Linearization of phase makes system usable as feedback up to 20 MHz

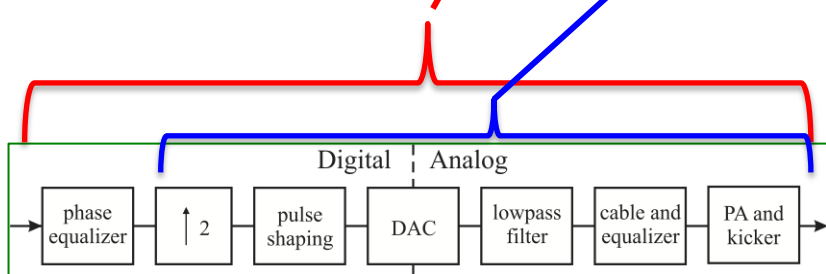

32 tap FIR
for phase equalization

LHC

W. Hofle et al., WEPME43

Shaping Time Domain Response

- Motivated by appearance of single bunch instabilities
- Used operationally for squeeze and 25 ns spacing tests

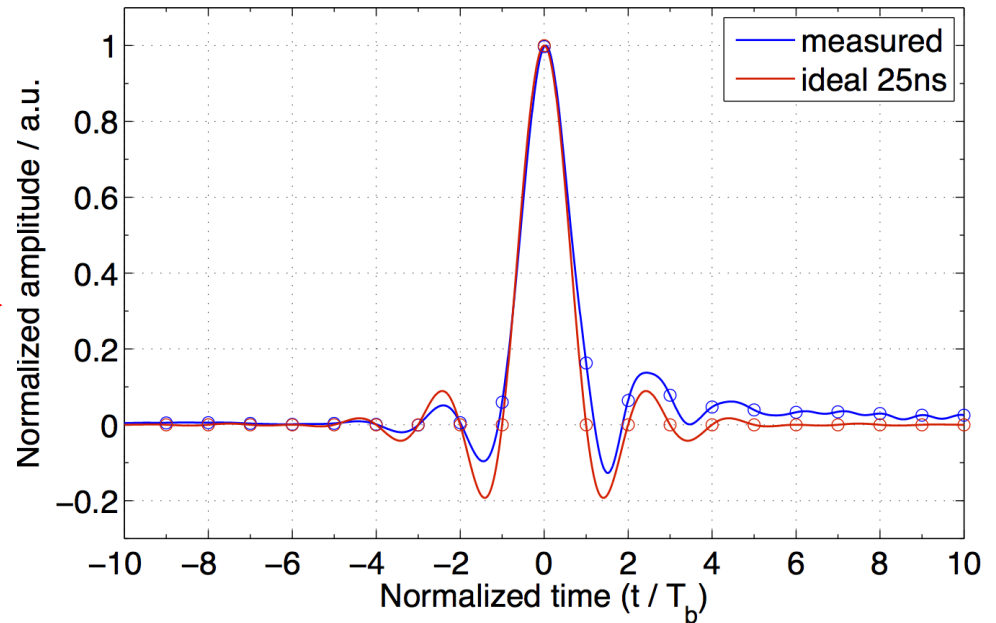
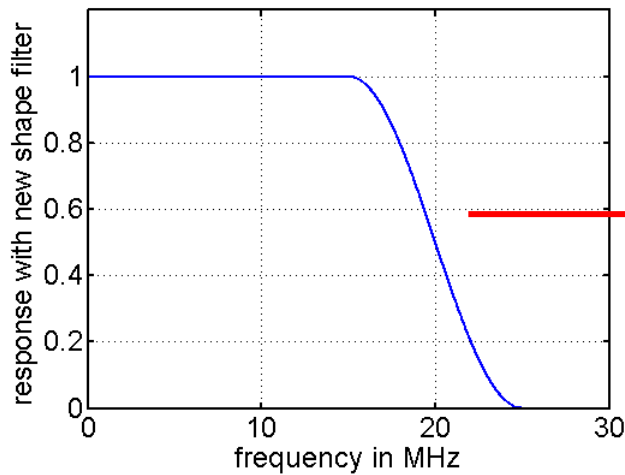
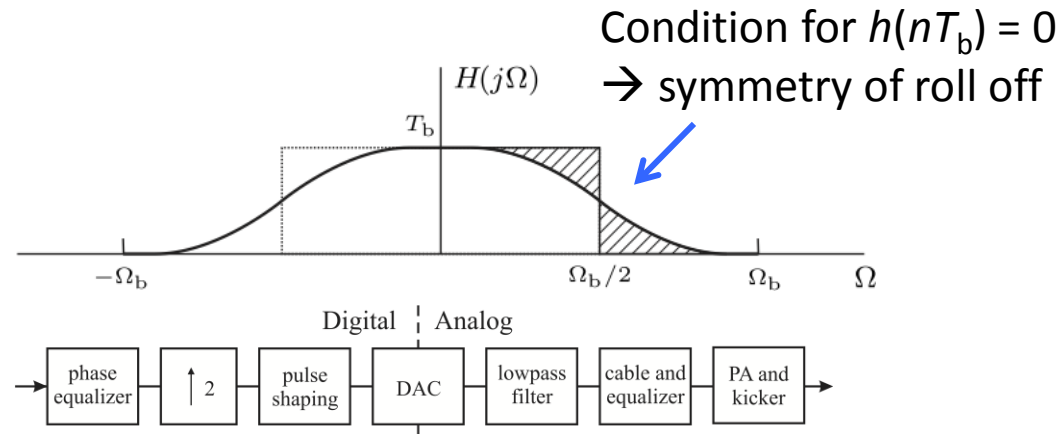

Diagnostics: The Fixed Display

beam 1: transverse injection transient, pilot

Damper off

