

Alessandro Variola (LAL, Orsay)
variola@lal.in2p3.fr



The ThomX Project

Work supported by the EQUIPEX program - Ministère de la recherche, Ile-de-France region, CNRS-IN2P3 and Université Paris Sud XI

The ThomX Project

• Compton effect

- **ThomX is a light source based on Compton Back Scattering (CBS)**
- **Why CBS?**
- CBS is by far the most efficient photon energy amplifier : $\omega_{\text{diff}} = 4\gamma^2 \omega_{\text{laser}}$, ThomX $\Rightarrow \gamma \sim 100 \Rightarrow$ it is possible to have at one's disposal hard X rays with a relatively low energy electron machine.
- **But for a light source:** $\sigma \sim 6.6524 \cdot 10^{-25} \text{ cm}^2$. it is low!!!!
 - Thomx target is a high AVERAGE flux so we need many electrons and photons colliding in a small volume at high freq \Rightarrow CHOICE:
 - Storage ring + high average power laser amplified in a Fabry Perot resonator (French collaboration among different kinds of expertise)
- CBS attractiveness :
 - 1) Directivity (relativistic boost) = $\rightarrow f = 1/\gamma$ around the electron direction
 - 2) Energy angle dependence \Rightarrow monochromatic by diaphragm
 - 3) Polarized if needed
 - 4) Backscattered spectrum cut off \Rightarrow Energy dependence on collision angle

Scientific Case

•Cultural heritage and medical science

- Transfer of the SR techniques to these new machines. Many fields can be interested...
- At present two contributors: Medical field (ESRF, INSERM Grenoble)
Cultural Heritage (C2RMF CNRS - Louvre Museum)

•Painting analysis

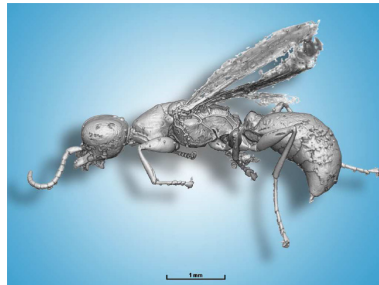
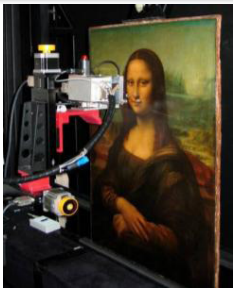

- Paleontology
- Non-destructive analysis

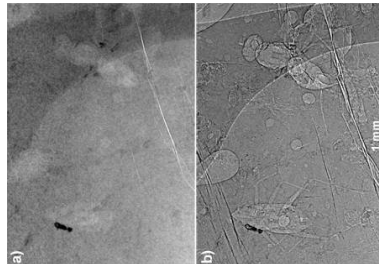

- K-edge imaging (Pb→white, Hg→vermillion...) of a Van-Gogh's painting
- J. Dik et al., *Analytical Chemistry*, 2008, 80, 6436

- Physiopathology and Contrast agents,
- Dynamic Contrast Enhancement SRCT
- Convection Enhanced Delivery =>Stereotactic Synchrotron RT

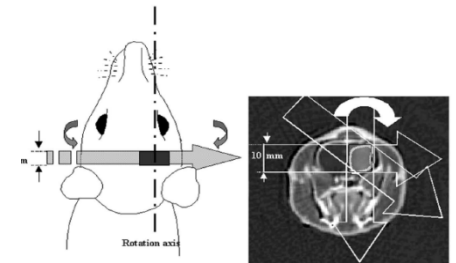
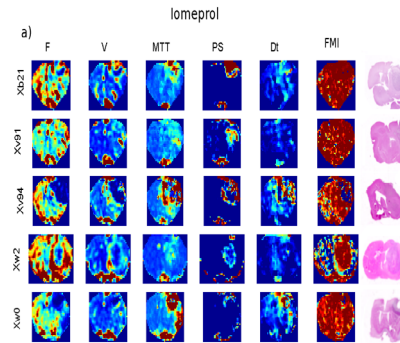
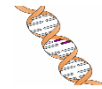

- Imaging,
- Mammography
- Microtomography

•Biston et al, *Cancer Res* 2004, 64, 2317-23

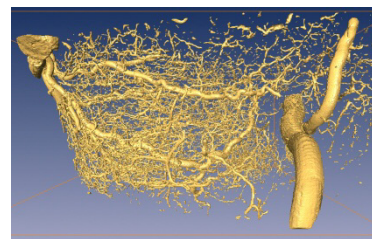

•J Cereb Blood Flow and Metab, 2007. 27 (2):292-303.

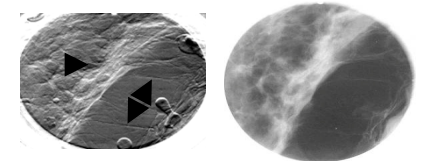

•Journal of Radiology 53, 226-237 (2005)

• Acknowledgments to G.Le Duc, P.Walter

How it works

• ThomX scheme and design

- Cycle Freq = 20 msec
- RF pulse length 3 μ s
- Energy 50 - 70 MeV

- 2 Ips
- Easy integration
- Frees the straight sections
- CSR line

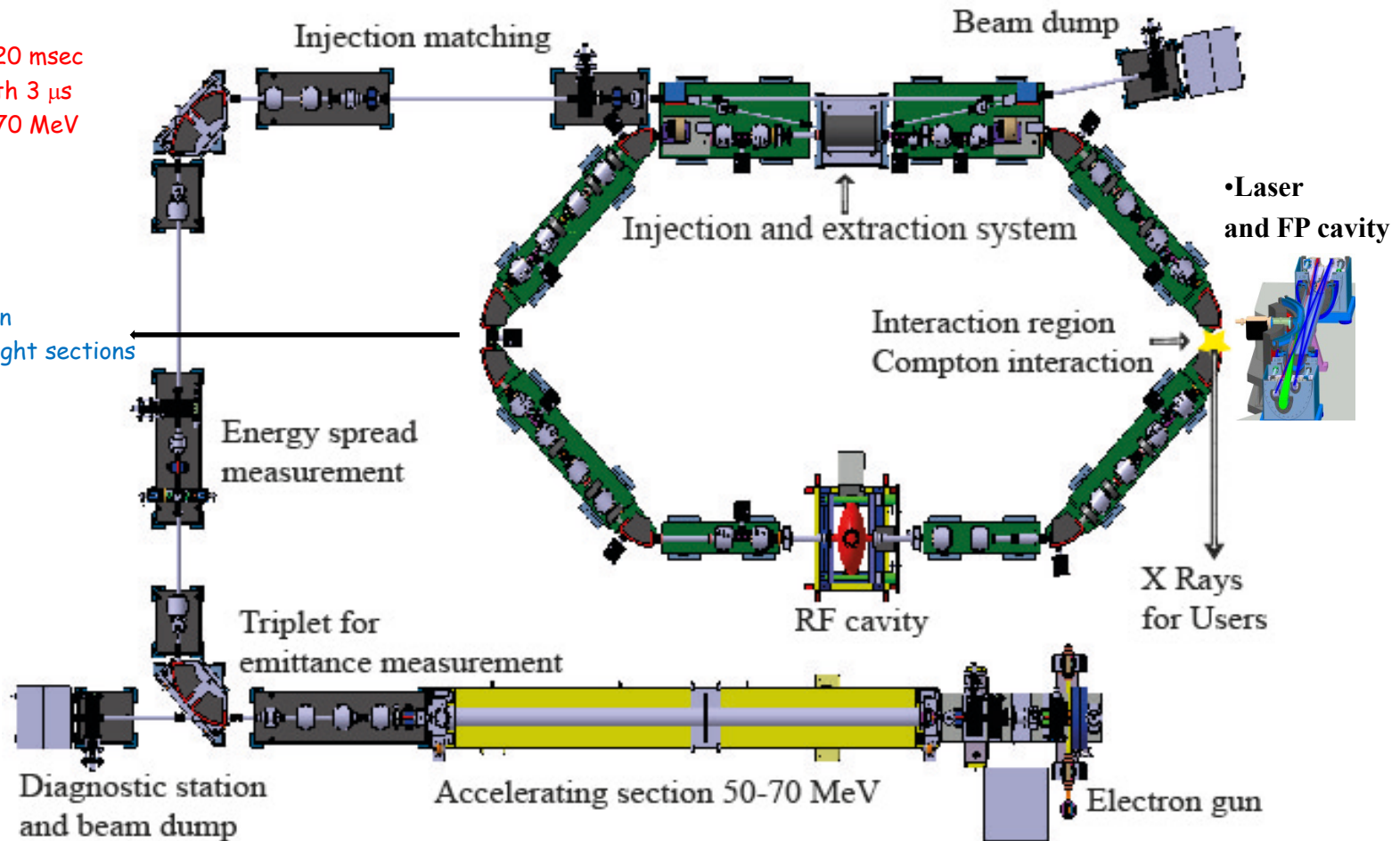

• Acknowledgments to M.Jore, M Lacroix

Expected beams characteristics

•Injector, ring, laser, Fabry-Perot resonator and the source

Injector		Ring	
Charge	1 nC	Energy	50 MeV (70 MeV possible)
Laser wavelength and pulse power	266 nm, 100 μ J	Circumference	16.8 m
Gun Q and Rs	14400, 49 MW/m	Crossing-Angle (full)	2 degrees
Gun accelerating gradient	100 MV/m @ 9.4 MW	$B_{x,y}$ @ IP	0.2 m
Normalized r.m.s emittance	8π mm mrad	Emittance x,y (without IBS and Compton)	$3 \cdot 10^{-8}$ m
Energy spread	0.36%	Bunch length (@ 20 ms)	30 ps
Bunch length	3.7 ps	Beam current	17.84 mA
Laser and FP cavity		RF frequency	500 MHz
Laser wavelength	1030 nm	Transverse / longitudinal damping time	1 s / 0.5 s
Laser and FP cavity Frep	36 MHz	RF Voltage	300 kV
Laser Power	50 - 100 W	Revolution frequency	17.8 MHz
FP cavity finesse / gain	30000 / 10000	σ_x @ IP (injection)	78 mm
FP waist	70 μ m	Tune x / y	3.4 / 1.74
Source		Momentum compaction factor α_c	0.013
Photon energy cut off	46 keV (@50 MeV), 90 keV (@ 70 MeV)	Final Energy spread	0.6 %
Total Flux	10^{11} - 10^{13} ph/sec		
Bandwidth (with diaphragm)	1 % - 10%		
Divergence	$1/\gamma \sim 10$ mrad without diaphragm @ 50 MeV		

Injector

- Electron gun and accelerating section

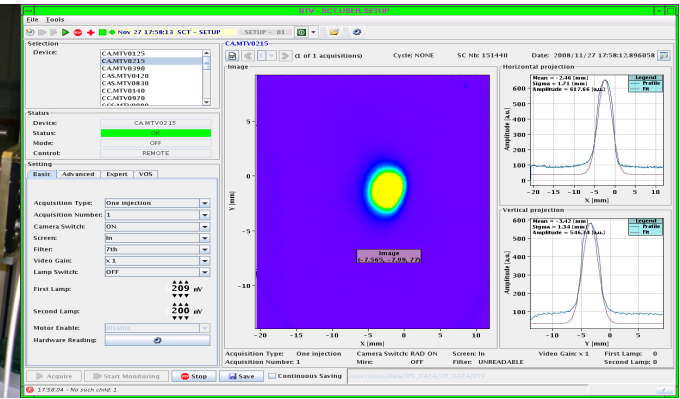
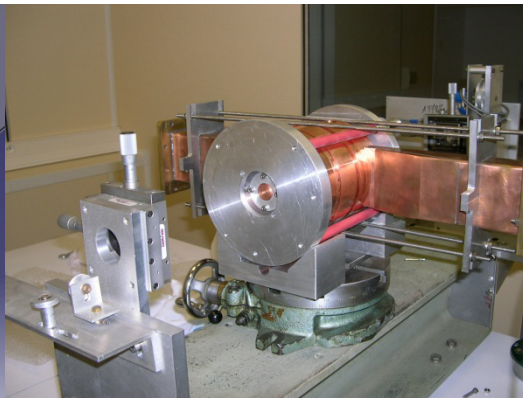
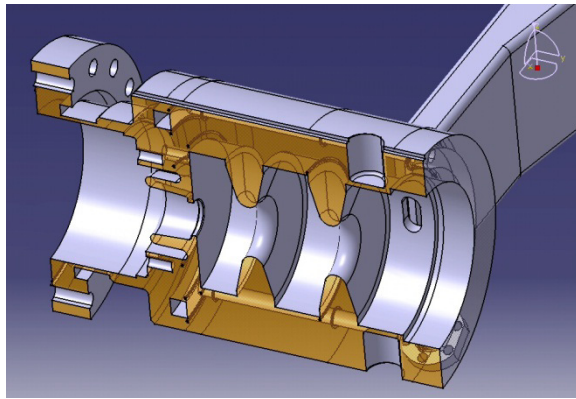







- Probe Gun, LAL Design,
- Already tested in the CTF facility for high current
- Accelerating section => LIL type section
- 4.6 m, 135 cells, 2.998.46 MHz @ 31 C°, mode 2 π /3.
- Q = 14800, 12.6 MV/m for the 50 MeV case
- Entrance => 160 cm from the cathode
- Phase stability required $\Delta\phi \leq 1^\circ$



• Acknowledgments to R.Roux, P.Marchand, J.P.Pollina

Transfer line

• Transport and diagnostics

-  4 correctors
-  4 stripline BPMs
-  3 screens
-  2 valves
-  2 ICT
-  1 scraper

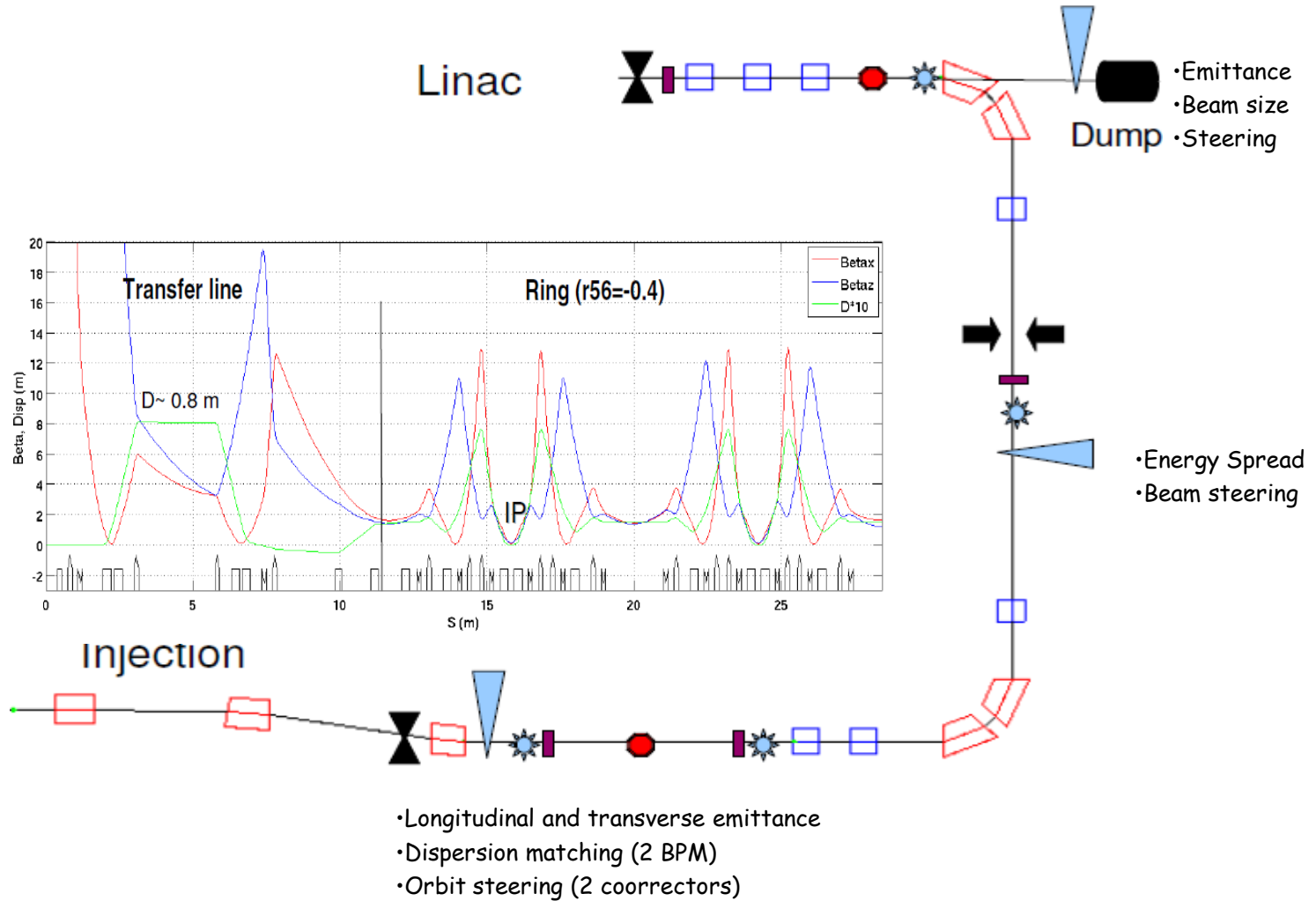

• Acknowledgments to A.Loulergue

Injection

One septum, two kickers

Injection section

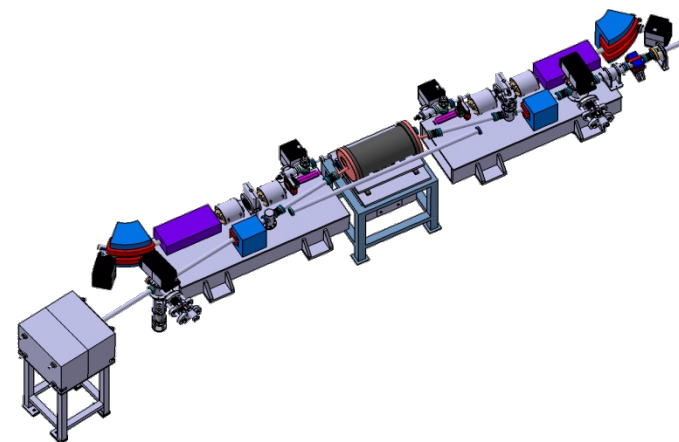
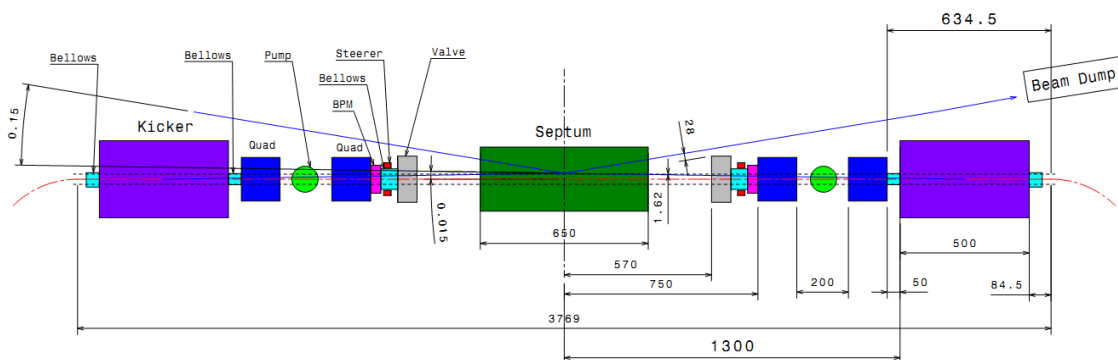

Equipment	Active length (mm)	Overall length (mm)	Transverse Beam stay clear		Septum thickness (mm)	Ceramic thickness (mm)	Equipment	Deviation (mrad)	Magnetic field length (mT)	Peak current (A)	Charging voltage (V)	Pulse shape	Pulse duration (μ s)	Repetition rate (max) (Hz)
			H (mm)	V (mm)										
Septum magnet	250	650	30	12	3		Septum magnet	150	100	960	150	full sine	130	50
Injection kicker	250	450	40	28		6	Injection kicker	15	10	420	12500	half sine	0.050	50
extraction kicker	250	450	40	28		6	extraction kicker	15	10	420	12500	half sine	0.050	50

• R&D => pulsed power supplies for the kicker magnets (ring revolution 56 ns) => a very high di/dt (~ 20 kA/ μ s), fast rise time and fast blocking of the negative current, and a very small time jitter

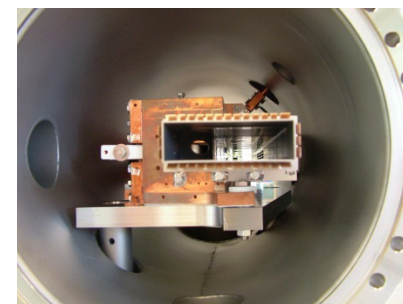
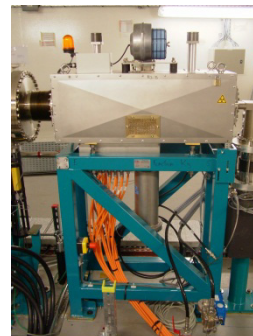

• Acknowledgments to P.Lebasque, T Vandenberghe

Ring

Linear optics and mechanics

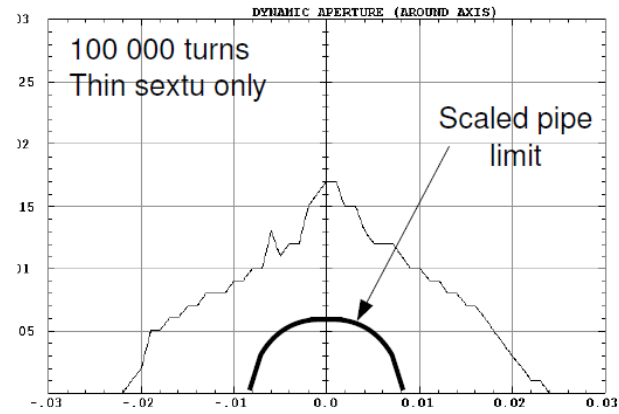
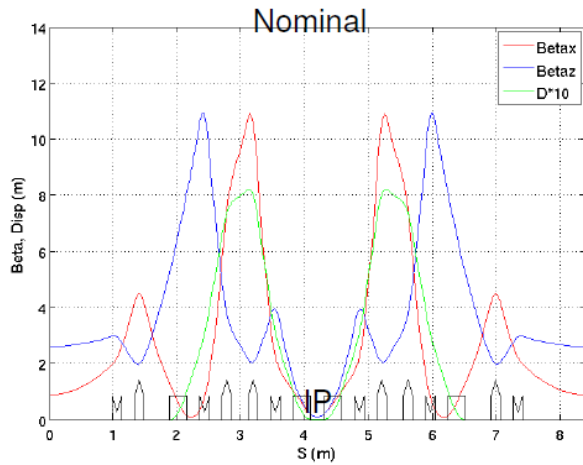

$$\beta_x = \beta_z = 1.8$$

• Supports

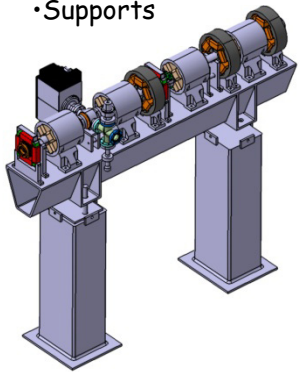

• Bellows

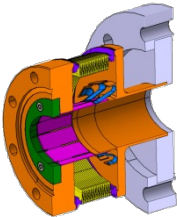

• X Line

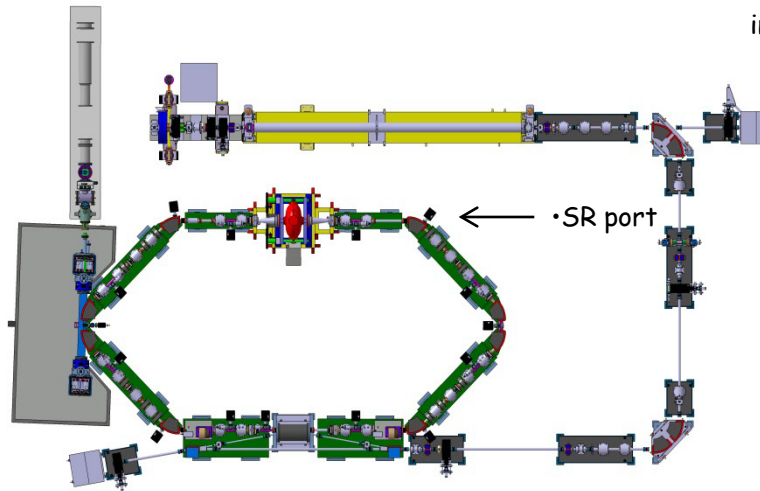

• SR port

• Pumping and integrated SR port

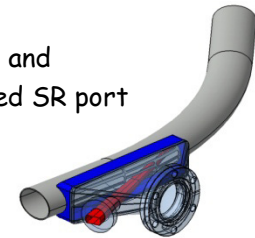

• Pumping ports

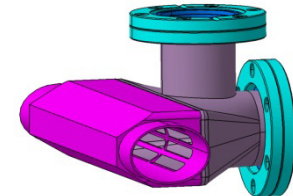

• Acknowledgments to A.Loulergue, T.Vandenberghe, C.Prevost, B.Mericer, A.Gonnin, R.Marie

Ring RF

Cavity, Rf source and feedback

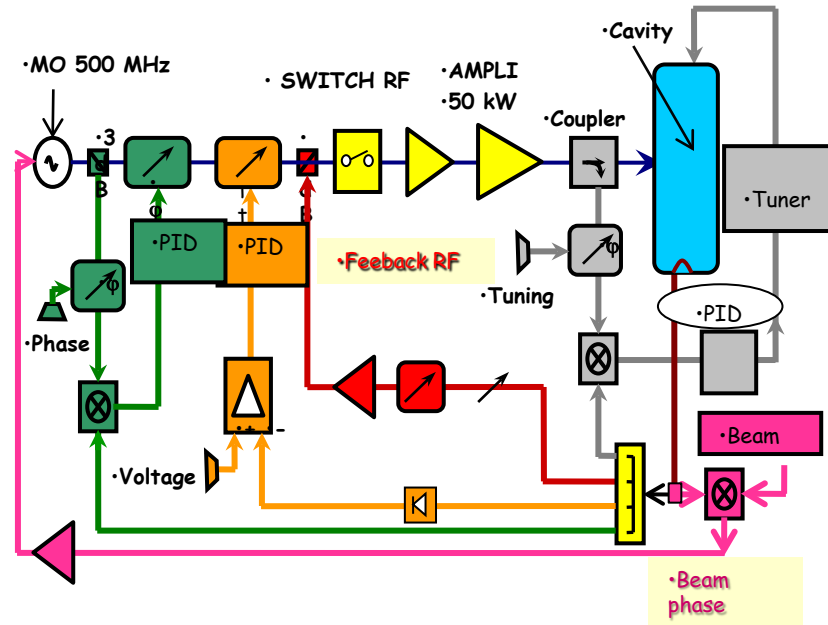
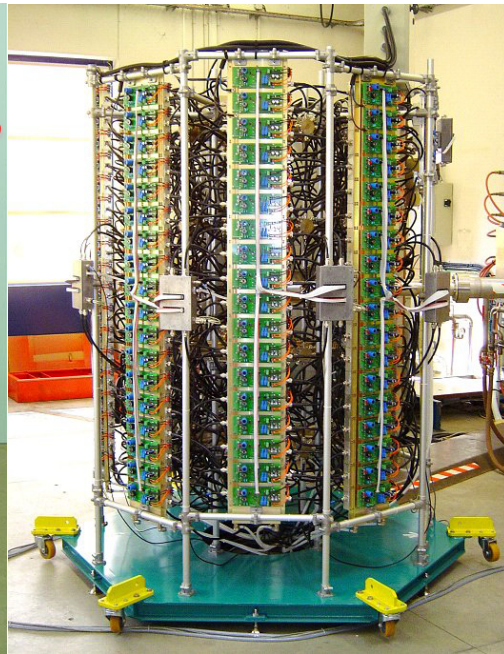
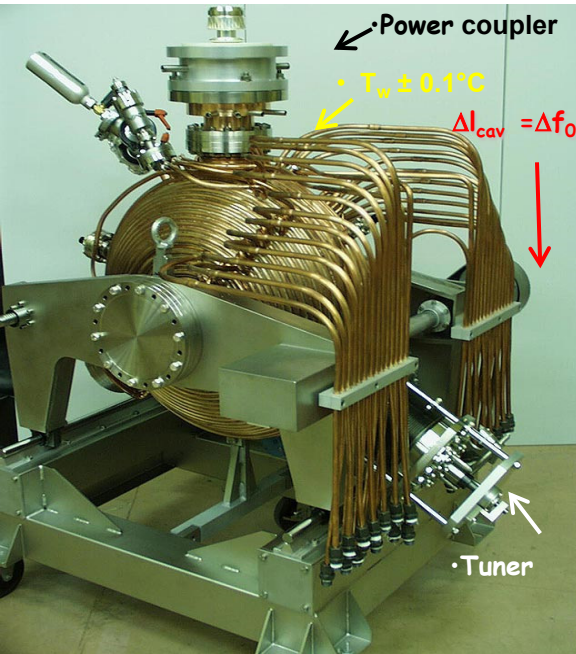

'Elettra' type cavity

- 3 different tuning knobs
- Temperature (30÷60 C°, ±0.05 C°)
- Mechanical length adjustment Δl
- Tuner on the equator

'SOLEIL' type transistor amplifier

- No HT, modularity (easy to maintain)
- Tested (5 years, +25,000h of operation)
- Operational efficiency 99.995%
- 1 Module @352 MHz 330W \Rightarrow Can be extended to 500 MHz

'Slow and Fast feedback

- Slow Amplitude, phase, frequency loops
- Fast RF FB
- Phase loop \Rightarrow beam oscillations @ 500 kHz, $\Delta\Phi_{inj}$, HOM,...

• Acknowledgments to P.Marchand

Beam Dynamics

Injection and instabilities. Compton effect

- Transient dynamics (no equilibrium)
- Compton recoil
- Collective instabilities
- CSR, Ions, Vacuum scattering, IBS.....
- Injection mismatching

- Feedbacks!!!!
- Ion clearing
- Simulations

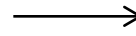

- 3 Phases
- Injection
- Turbulent regime
- Stabilization (thousand turns)

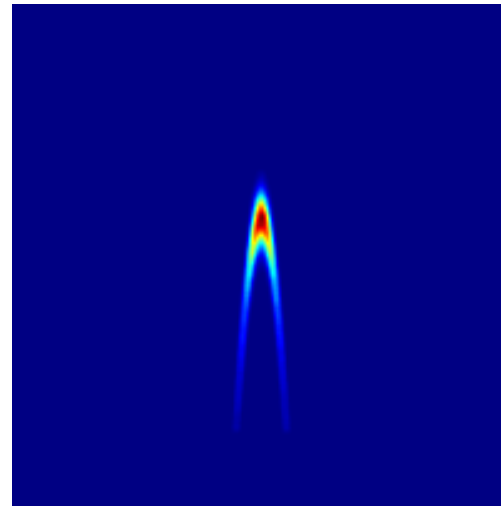
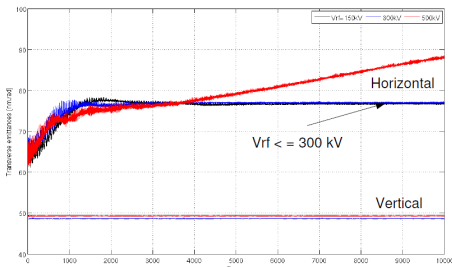

• Careful to the brilliance !!!

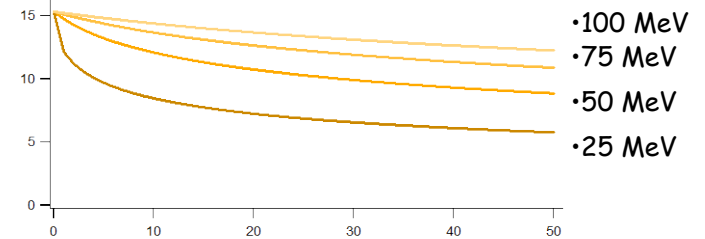
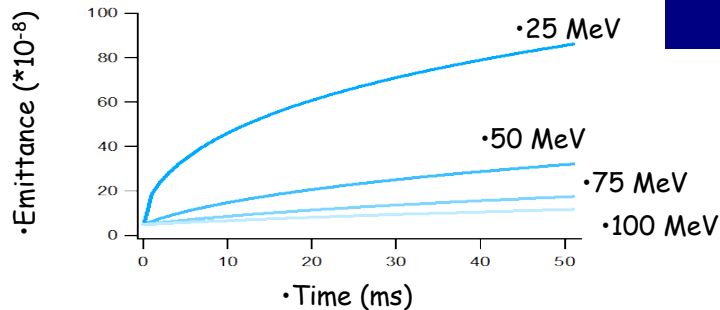
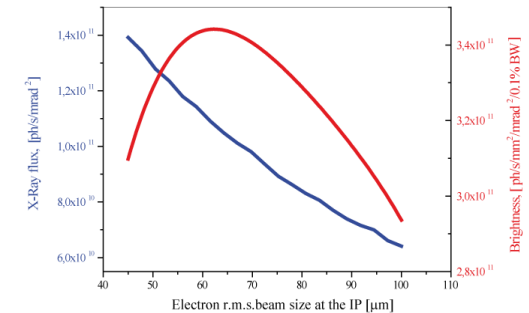

• Acknowledgments to A.Loulergue, C.Bruni

Diagnostics

Linac, transfer line and ring

•In-flange Integrating Current Transformer

- 5.0 Vs/C sensitivity
- Electronics: BCM-IHR with 2 ranges: 0.8 -2 nC
- Acquisition: ADC 12 bits 100kHz

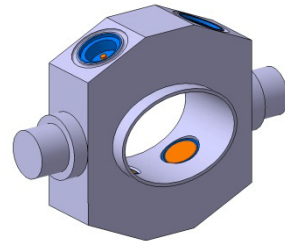
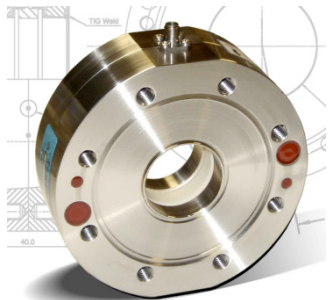

- 17 Button BPM in the ring.
- Absolute precision: <math>< 50 \mu\text{m}</math>
- Resolution: $\sim 1 \mu\text{m}$

- Linac Stripline BPMs: $\lambda/4$,
- 500 MHz, resolution = $100 \mu\text{m}$ for 1 nC

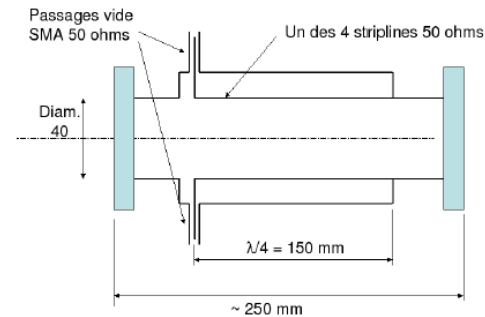

- 1 Pepper pot

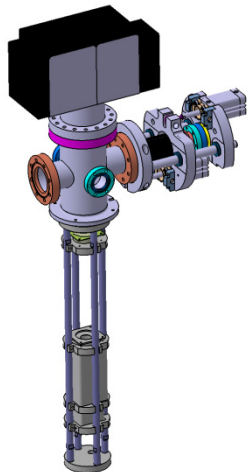
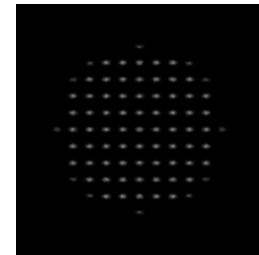

- Diagnostic Station:
 - 1 design for a set of diagnostics at 4 different locations
 - Elements: 2 or 3 screens
 - 1 OTR : 25 mm diameter, $100 \mu\text{m}$ aluminized silicon wafer
 - 1 YAG(Ce) : 25 mm diameter, $100 \mu\text{m}$ thick,
 - Crystals: 1 sapphire screen
 - Stepper motor to mount the screens
 - View port: Fused Silica DN 60 CF
 - 1 CCD: Basler with gigabit ethernet
 - 1 or 2 objective (s)

•Beam losses => fiber system

- 1 SR light port

- Extraction @ 15° - 63 mrad x 32 mrad aperture
- Dipole BM5

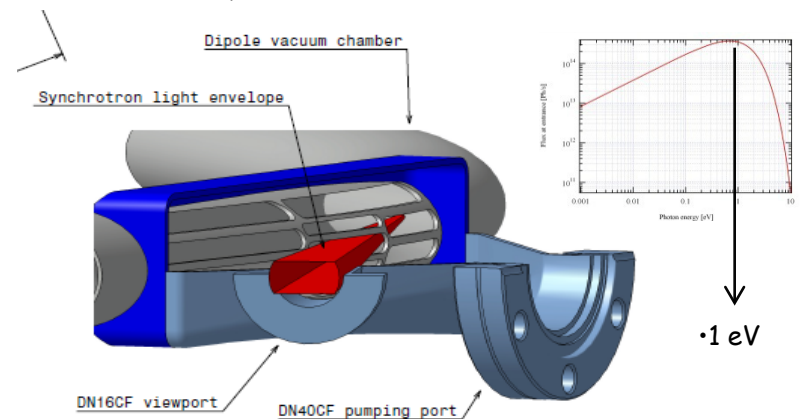

•1 eV

Synchronisation

MightyLaser (KEK ATF) experience

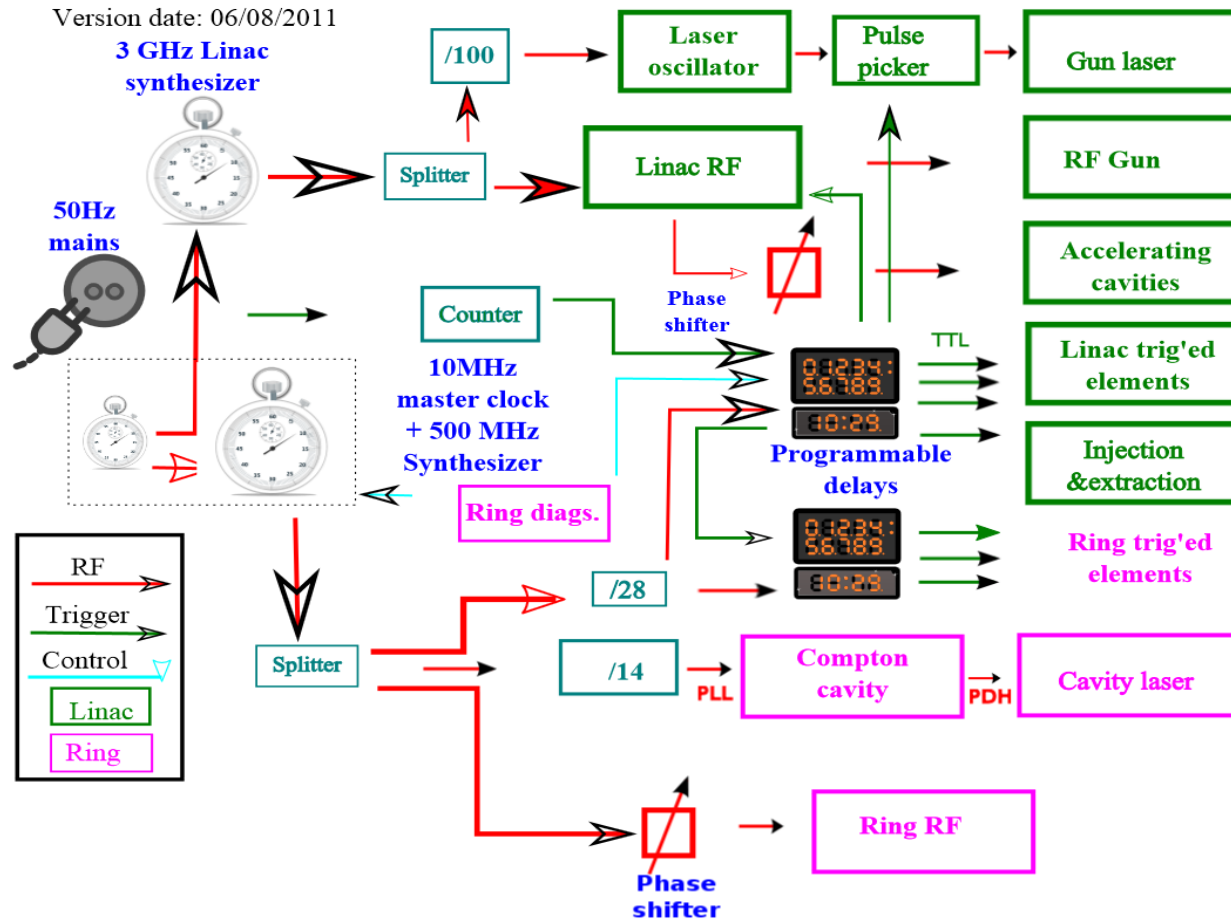

• Acknowledgments to N.Delerue

Controls

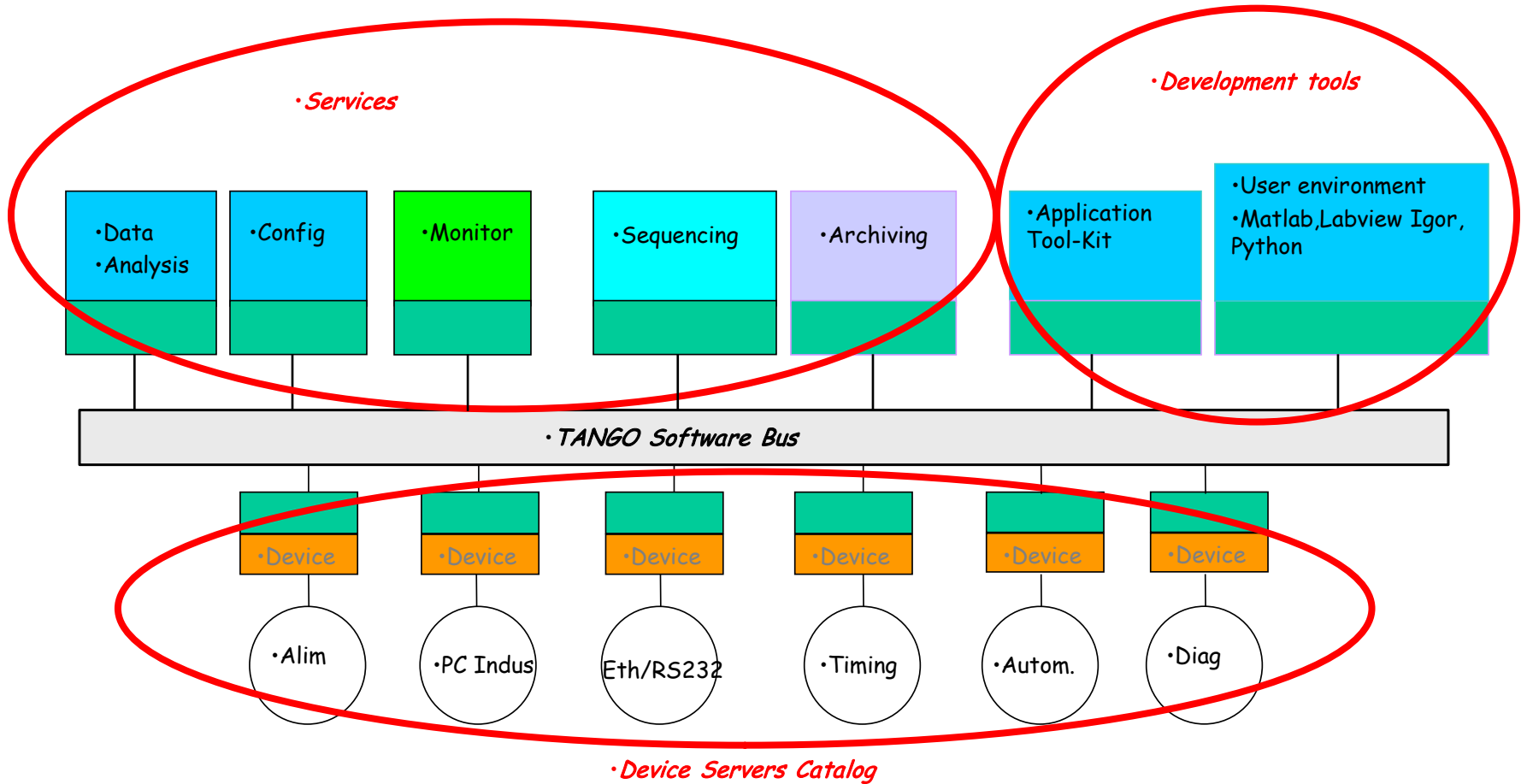

Laser

•The MightyLaser experience

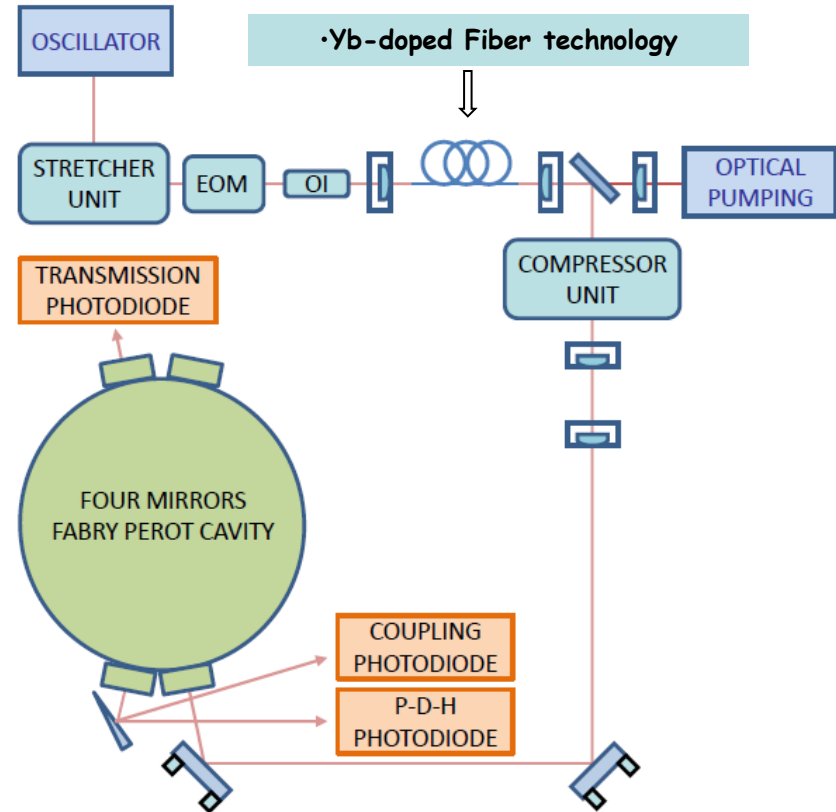
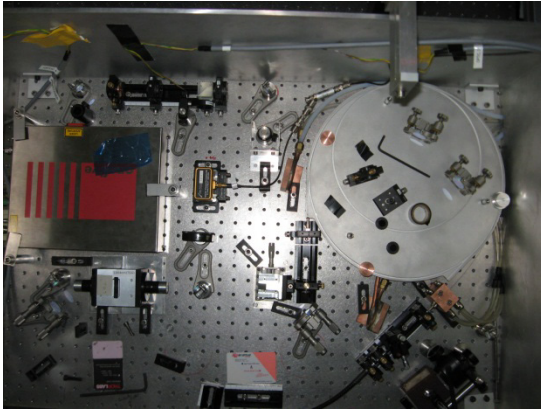

•CPA for Mighty Laser

•Oscillator
•178 MHz

•Stretcher
•unit

•Fiber amplifier
50 W

•E = 281 nJ
•T = 100 ps
•P_{peak} = 2,8 kW
•I = 42 kW/cm²
•B = 0,24 rad

•Compressor
•unit

•FP Cavity

•Compatible with low noise amplification

• Acknowledgments to E.Cormier, V.Soskov, F.Labaye

Laser

• Towards ThomX, (178 => 35 MHz)

• New developments:

• Integration (all-fibered)

- Mode adaptors (tapers)
- Fiber connectorization
- Specialty fiber splicing
- Integrated optics
 - (EOM, CVBG, Isolators, ...)
- High power beam combiners
- Fiber end facet preparation
 - (sealing, polishing, endcap,)
- Tests (heat management, losses,
 - mode quality, reflections, ...
 -

• Architecture (fiber or hybrid)

- Design of new large core fibers
- Design of integrated
 - stretcher-compressor units
- Evaluation of hybrid architectures
 - Fiber + Bulk

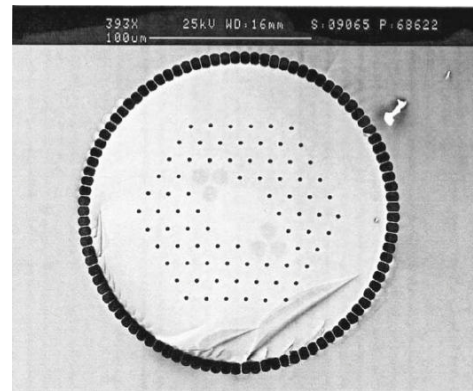
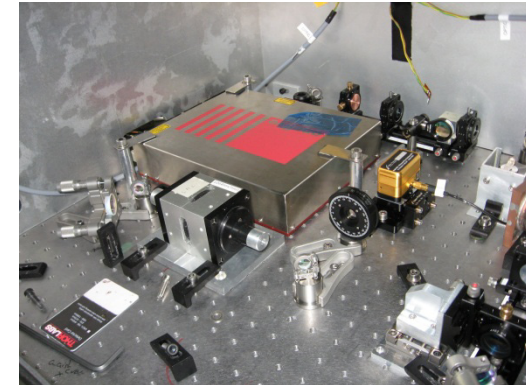
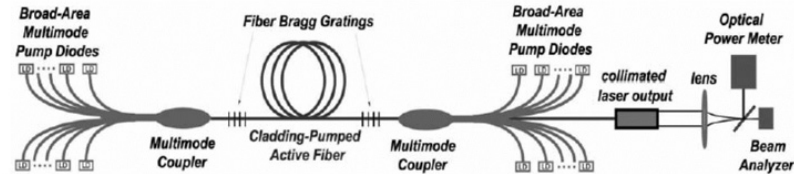

• Acknowledgments to E.Cormier, V.Soskov

Fabry-Perot cavity

MightyLaser and PLIC experience

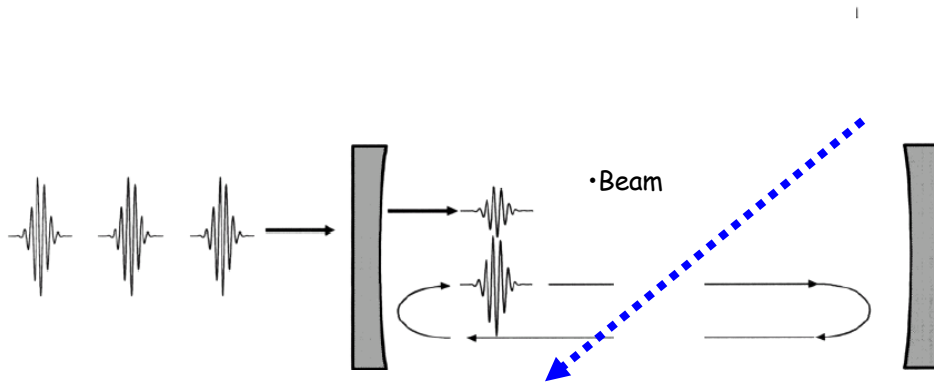

• Gain = $1/(1-R) \sim 10000$

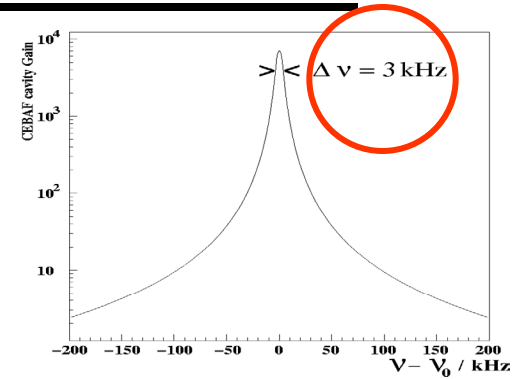

• Digital Pound-Drever-Hall feedback

• Vacuum and mechanics : MightyLaser experience

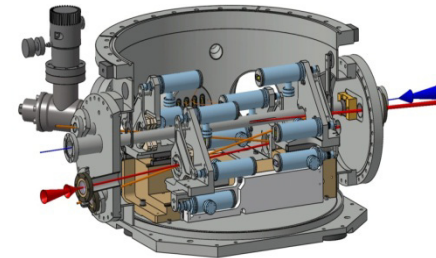
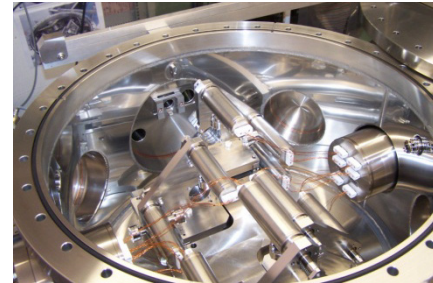
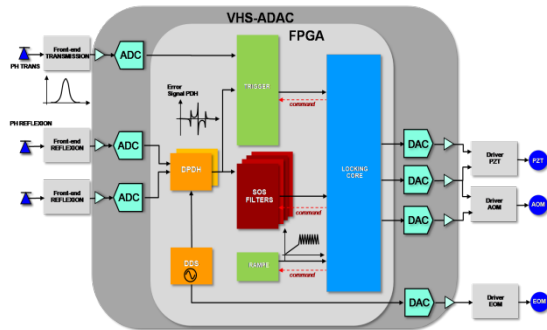
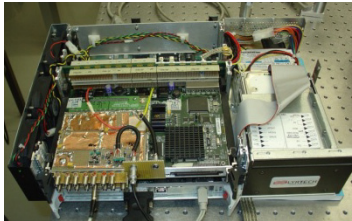

• PLIC and MightyLaser : record in stable finesse locking (30000).

• Acknowledgments to F.Zomer, R.Chiche, D.Theanno, M.Lacroix, R.Cizeron

Fabry-Perot cavity

• Towards ThomX

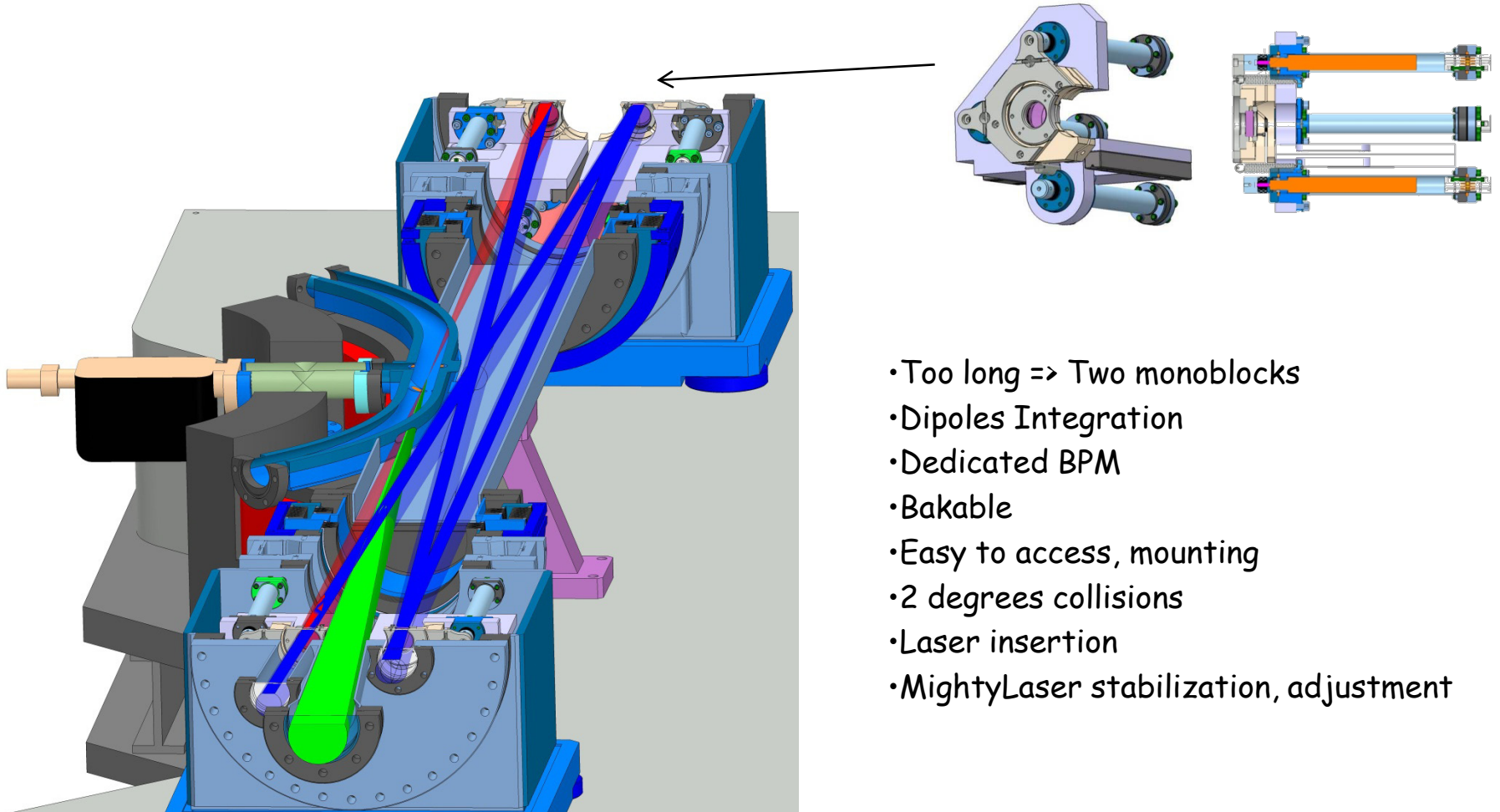

- Too long => Two monoblocks
- Dipoles Integration
- Dedicated BPM
- Bakable
- Easy to access, mounting
- 2 degrees collisions
- Laser insertion
- MightyLaser stabilization, adjustment

• Acknowledgments to M.Lacroix, Y.Peinnaud

X ray line

• X ray characterization. Users to be defined

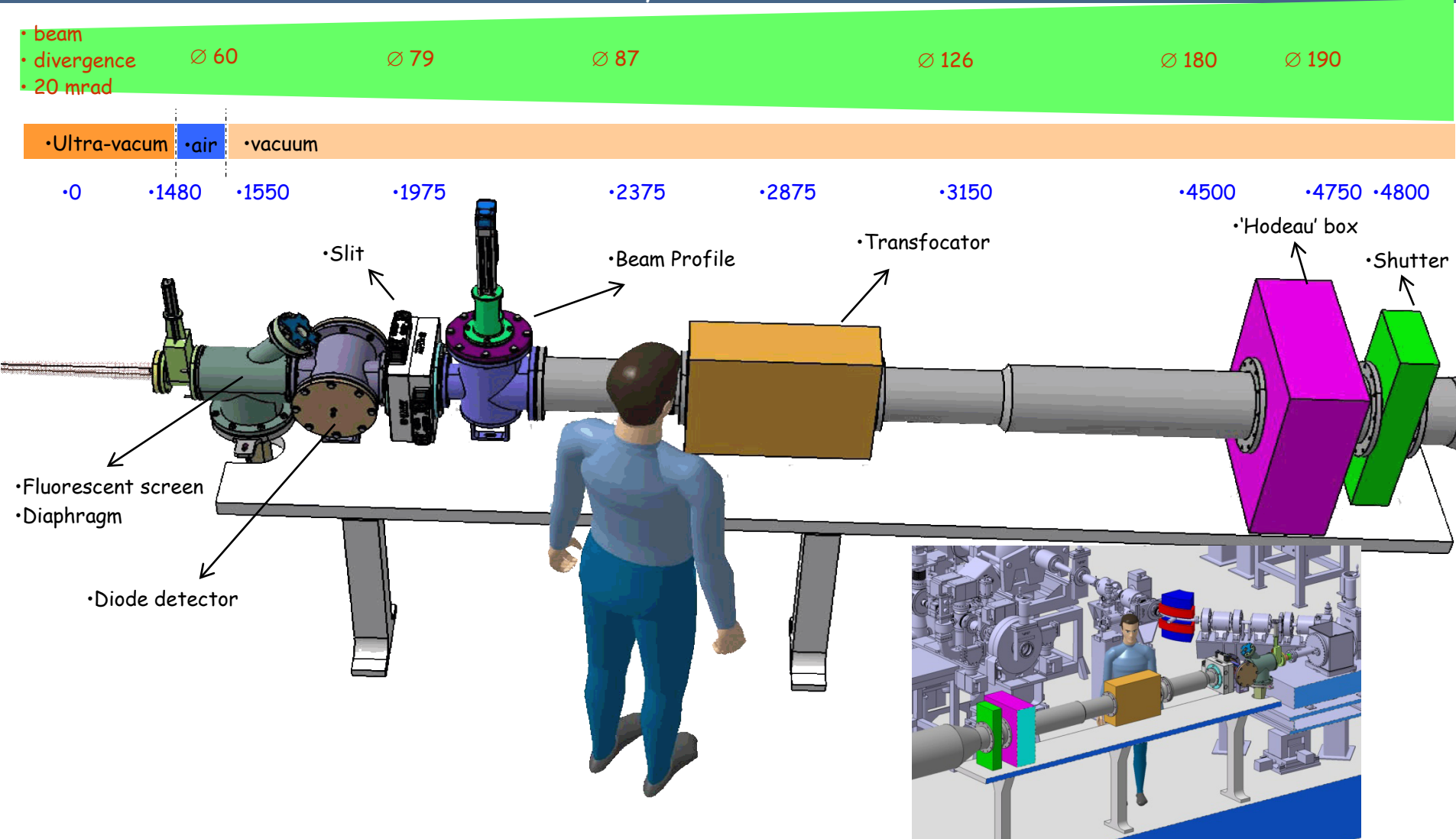

• Acknowledgments to M.Jacquet, J.L Hodeau, J.L Hazemann, P.Jeantet

Integration and Site

Paris-Sud University Campus

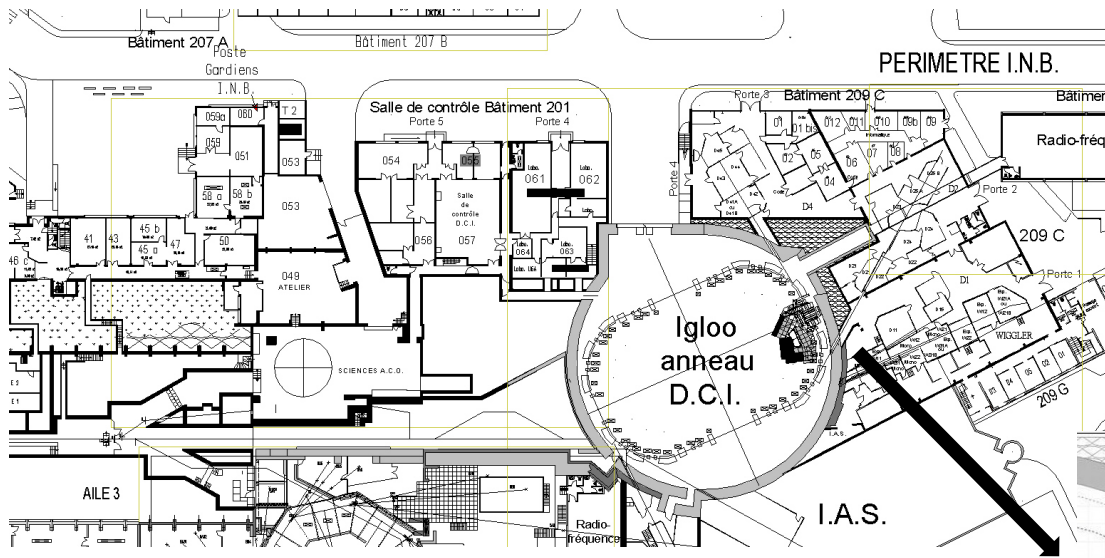

• OLD Orsay IGLOO

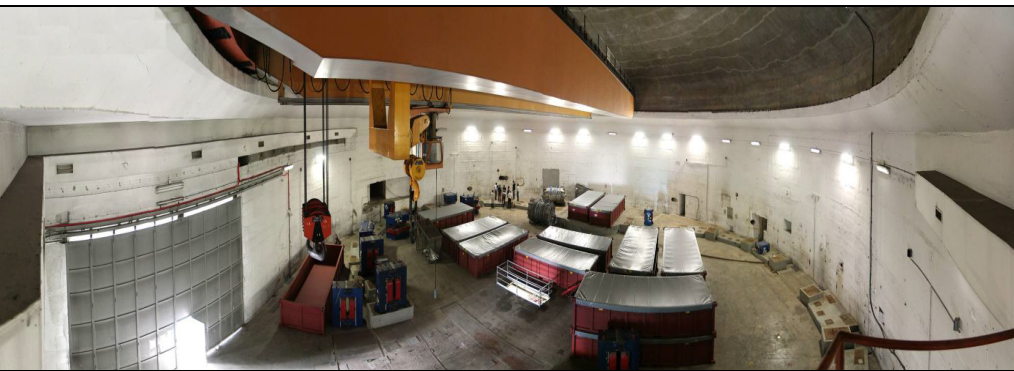
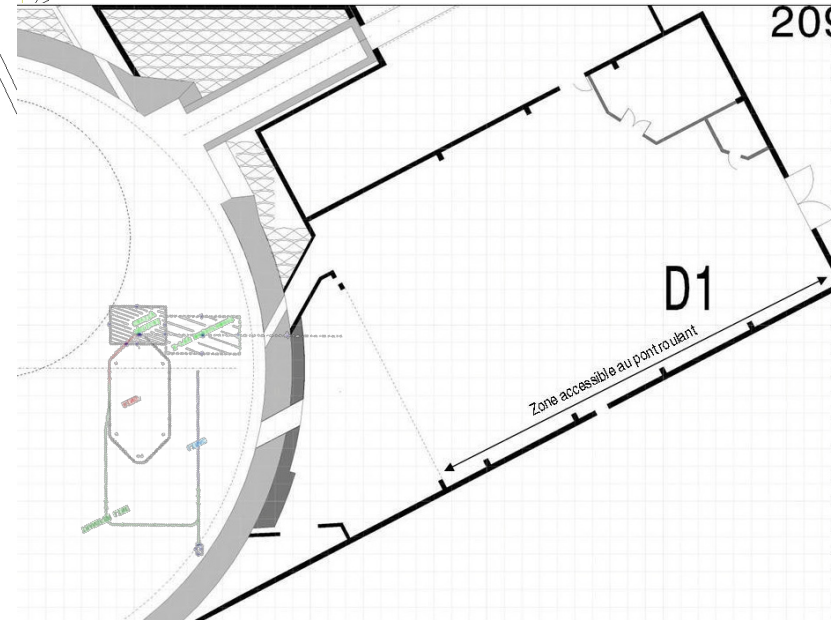

• Acknowledgments to A.Pichot, M.Tran

•The ThomX Project

•CDR

LAL RT 09/28
SOLEIL/SOU-RA-2678

- 42 Contributors
- 7 Research partners/ 1 Company
- 136 pages / 7 chapters
- Internal review committee. Eight international experts
- Published as a note:
 - LAL RT 09/28
 - SOLEIL/SOU-RA-2678

THOMX Conceptual Design Report

Editors:
A.Variola
A.Loulergue
F.Zomer

Conclusions

- Different kinds of expertise in French Labs => Compton X Rays source
- Collaboration established, CDR published
- Financing!!!! Equipex (French minister), Ile-de-France Region, CNRS-IN2P3, Université Paris Sud XI
- TDR phase close to the end
- Very nice accelerator and laser physics
- Beam dynamics and technology R&D
- Industrial collaboration and user access expected
- Education!!!
- Construction starts in 2012

- Other IPAC Conference papers and posters correlated with ThomX
- C.Bruni et al MOPS050
- I.Chaikovska et al. WEPC051
- N.Delerue et al. TUPO002
- P.Marchand et al. MOPS127

- Thanks for your attention !!!!!!!

- Thanks to all the ThomX staff (unfortunately I cannot mention everybody.....). They all contributed to the design and the study of the machine