

## SLED TUNING CONTROL SYSTEM FOR PAL-XFEL\*

Y. J. Suh<sup>†</sup>, G. Mun, K.H. Kim, Y.J. Park, H. Heo, C.B. Kim, H.S. Kang  
Pohang Accelerator Laboratory, Pohang, Korea

### Abstract

A total of 42 SLED(SLAC Energy Doubler)s are installed at the Pohang Accelerator Laboratory-XFEL linac section. The PAL-XFEL SLED has a system that controls the resonance of the cavity by installing the motor in a way that adjusts the cavity volume. The controller uses Beckhoff [1] PLC and TwinCAT3, and the communication with EPICS IOC uses TCP-IP and it was made with Asyn motor. 42 slave unit and master unit are connected by optical cable and 1:1 connection. So, if one unit is faulty and does not work, the remaining 41 units can operate normally. In this paper, we describe the introduction and results of the SLED tuning control system.

### HARDWARE FEATURES

The Sled Tuning Control system is a device for controlling the motor with a motor connected to the center axis of the SLED cavity. Figure 1 shows the shape of the mechanism and motor installed in the tunnel.

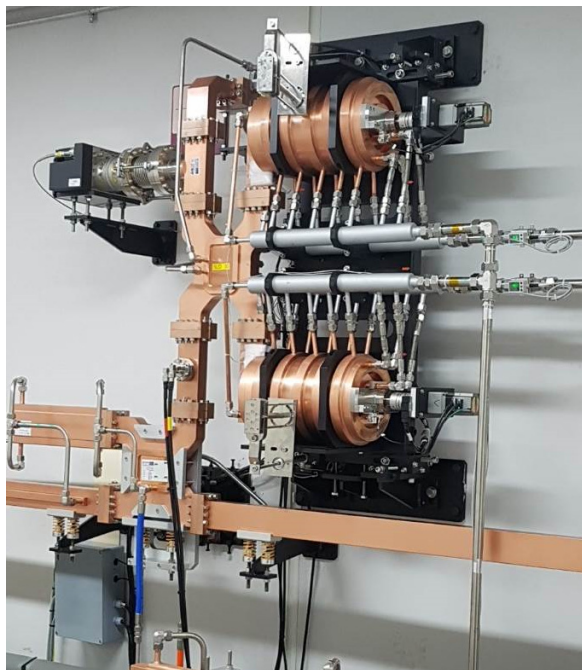

Figure 1: Sled cavity in Tunnel wall.

Figure 2 shows the shape of the junction box installed on the inner wall of Tunnel. The upper part is the amp of LVDT and the lower part is the cable of motor, limit sensor, motor brake.



Figure 2: Junction Box in tunnel wall.

The controller uses Beckhoff PLC and it can be controlled by adding various devices to the I/O part even if the device is completed with good scalability and usability. Actually, a device called wire scanner will be connected and controlling. Figure 3 shows the slave unit installed in the gallery and Fig. 4 shows the master unit installed in Server Room.

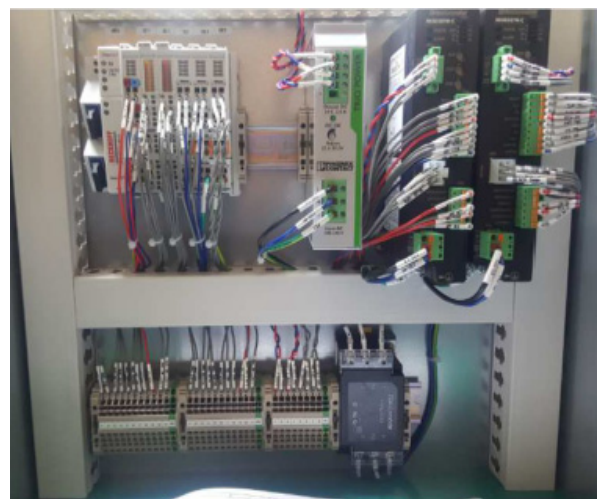

Figure 3: EtherCat Slave unit in Gallery Rack.

Content from this work may be used under the terms of the CC BY 3.0 licence (© 2019). Any distribution of this work must maintain attribution to the author(s), title of the work, publisher, and DOI.

\* Work supported by Ministry of Science and ICT, South Korea

<sup>†</sup> yjseo@postech.ac.kr



Figure 4: EtherCat Master unit in Server Room Rack.

### CONTROL SYSTEM

As shown in the Fig. 5, the instrument is connected to the slave unit via a dedicated cable, and the slave and master are connected by an optical cable. We tried to install the Encoder to read the exact position of the motor but due to the structure of the instrument I installed a Digital Probe (LVDT). Due to the structure of the mechanism, it cannot be used as a close loop and is used as an open loop.

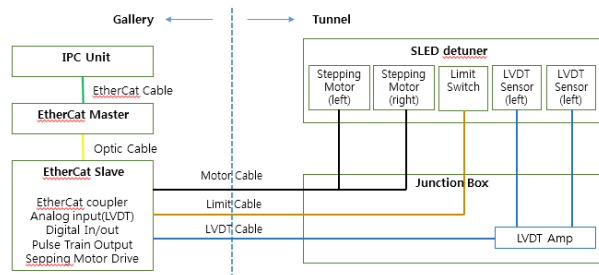

Figure 5: Sled tuning control system detail layout.

The configuration of the overview control system is shown in Fig. 6, and MDF and FDF are optical communication distribution devices and are connected by optical cable. IPC is a PC provided by Beckhoff and installs Beckhoff program and EPICS IOC in this IPC. Beckhoff Program version is TwinCat 3 and IPC OS version is Window Embedded Standard.

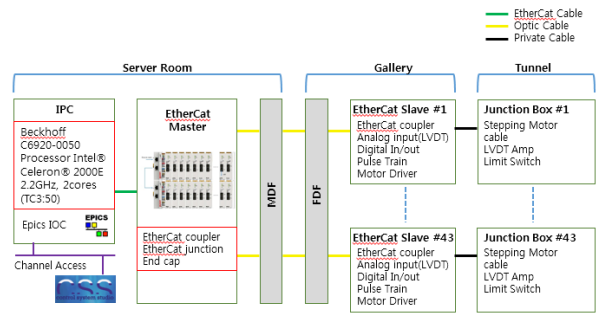

Figure 6: Communication connection layout of the Sled tuning control system.

Each FDF has a slave unit connected to each section as shown in Fig. 7, and since 1: 1 is connected, if one slave unit is disconnected, the other FDF can operate normally without problems.

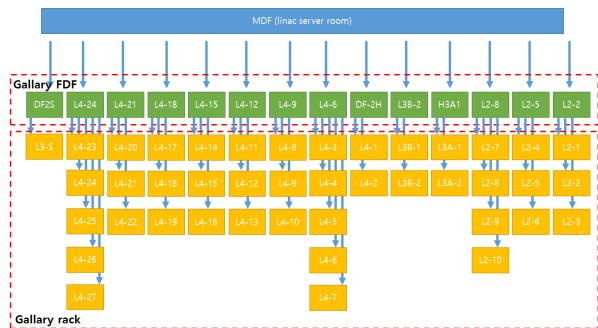

Figure 7: Layout of Optic Cable Connection.

The operation screen was created with CSS (Control System Studio) [2], and the EPICS IOC used Asyn motor. EPICS and beckhoff used TCP / IP and EPICS was con-nected to the channel access network. Figure 8 is the over-view screen showing the motor value and LVDT value, Fig. 9 is a detailed operation screen which can control each de-vice.

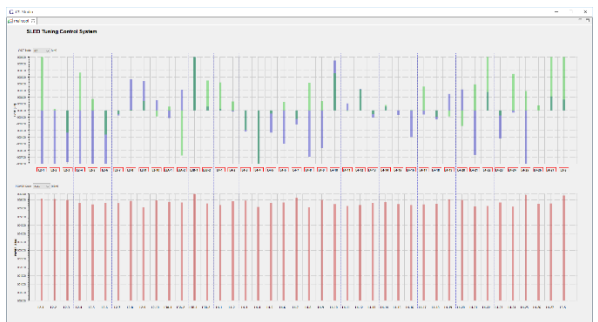

Figure 8: CSS Overview layout of Sled tuning control System.

Content from this work may be used under the terms of the CC BY 3.0 licence (© 2019). Any distribution of this work must maintain attribution to the author(s), title of the work, publisher, and DOI.

Content from this work may be used under the terms of the CC BY 3.0 licence (© 2019). Any distribution of this work must maintain attribution to the author(s), title of the work, publisher, and DOI.

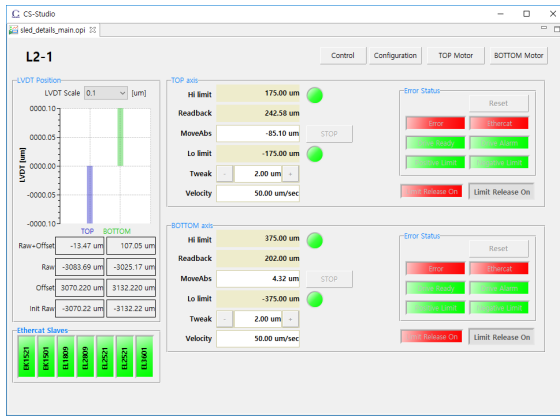

Figure 9: CSS Detail control layout of Sled tuning control System.

### CONCLUSION

The total of 42 pulsed energy doublers are installed in the PAL XFEL RF system. It consists of two resonators and one 3dB coupler. The amount of heat generated depends on the operation repetition frequency. There are two ways to prevent it. Change the water temperature of the cavity cooling system or adjust the volume of each resonator. We installed a system that can remotely adjust the resonator volume by connecting a motor to each resonator. Sled tuning

control system device was manufactured and the total of 253MW was increased due to the SLED tuning in 42 sections, and the effect of installing more than one modulator was obtained (Fig. 10). And it was possible to control what was done inside the tunnel by the person in the Operation Room.

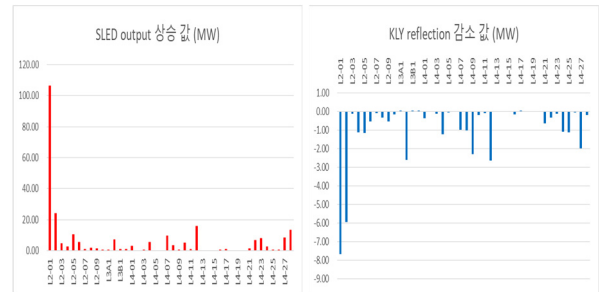

Figure 10: Sled output rise value and Klystron reflection decrease value.

### REFERENCES

- [1] BECKHOFF, <https://www.beckhoff.com/>
- [2] Control System Studio, <http://controlsystemstudio.org>