

# Comparison of Different Bunch Charge Monitors used at the ARES Accelerator at DESY

Timmy Lensch, Dirk Lipka, Reinhard Neumann, Matthias Werner

Saskatoon, 12<sup>th</sup> September 2023



HELMHOLTZ

12<sup>th</sup> INTERNATIONAL BEAM  
INSTRUMENTATION CONFERENCE

SASKATOON, CANADA  
September 10-14, 2023



# Outline

## 00 Motivation

## 01 ARES Overview

## 02 Faraday Cup

- Simulations, Mechanics, Electronics
- Calibration

## 03 Beam Charge Transformator (Toroid)

- Mechanics and Electronics
- Calibration

## 04 Dark Current Monitor (DaMon)

- Mechanics and Electronics
- Calibration

## 05 Turbo-ICT and ICT (Bergoz)

- Setup and read out

## 06 Measurements

- Linearity compared with Faraday Cup
- Resolution of DaMon, Toroid and T-ICT

## 07 Summary

# 00 Motivation

# Motivation

- The ARES eFLASH (medical) experiment needs an **absolute**, non-destructive charge measurement
- ARES normally operates at lower charges compared to other DESY machines (30 fC - 200 pC)
- ARES is an R&D machine → install different types of charge monitors (increase dynamic range&resolution)

## Beam Charge Monitors at DESY

- Use in-house developed Charge Monitors (beginning in the 1980s)
  - i.e. E-XFEL, FLASH = 60 monitors (Toroid type)
  - Transport Lines in other machines
- No (non-destructive) absolute measurement with such a dynamic range needed so far
- Important: Transport efficiency

This talk only presents dedicated charge monitors.  
At the ARES accelerator there are also Cavity BPMs installed.

This Conference: Poster MOP019 by Bastian Lorbeer  
IBIC2022: Poster WEB14

# 01 ARES Overview



# The ARES Linac

## A dedicated accelerator R&D machine

**ARES goal:** Generate and characterize **ultrashort e- bunches (fs to sub-fs)** with **high stability** for applications related to **accelerator R&D** (advanced & compact longitudinal diagnostics and accelerating structures development, test of new accelerator components, machine learning, etc.), **medical applications studies** and beam time for **external R&D users**.

Parameter	Status
Charge	0.01 - 250 pC
Momentum	20 - 160 MeV/c
Bunch Length	≈ 20 fs (res. limited)
Rep Rate (Single Bunch)	10 Hz

Contact: [florian.burkart@desy.de](mailto:florian.burkart@desy.de)

<https://ares.desy.de/>

Courtesy: Willi Kuroпка

Experimental Areas 2&3

T-ICT (in vacuum)  
ICT (in air)

Toroid

X-Band PolariX TDS (2 Cavities)  
(not operational yet)

Bunch Compressor  
(not operational yet)

DaMon, Toroid

Experimental Area 1 

Traveling Wave Structures (TWS)

Gun Diagnostics  
FC, DaMon

Gun

Cathode & pump lasers

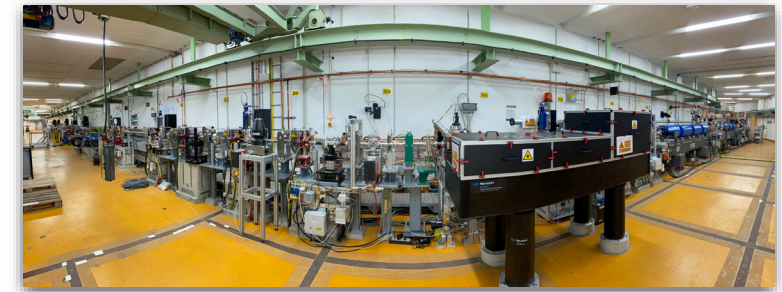
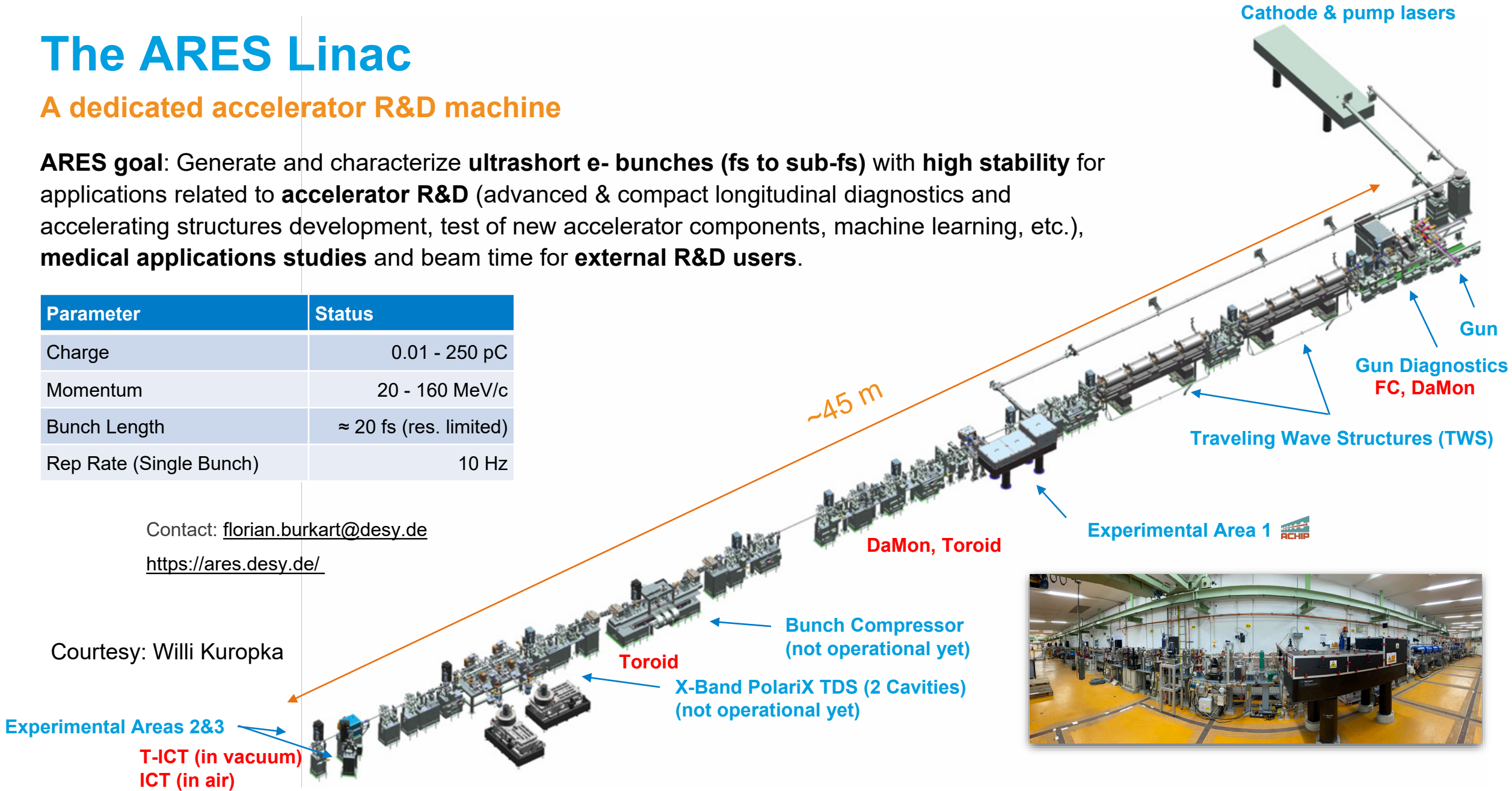

# 02 Faraday Cup (FC)

# Faraday Cup

## Simulation of new design for ARES

- Improvement of efficiency
- Optimized design with Cu cup + Al Inlay, 15 mm diameter, 24 mm depth simulated
- Found 0.6% of primary and secondary electrons escaping from the Faraday Cup at 5MeV
- Also different beam configurations and angles show very good results of <1% loss

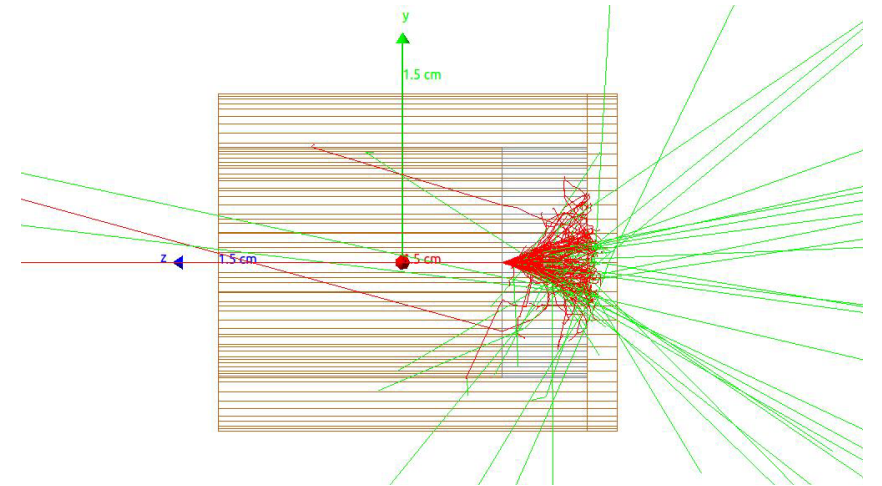
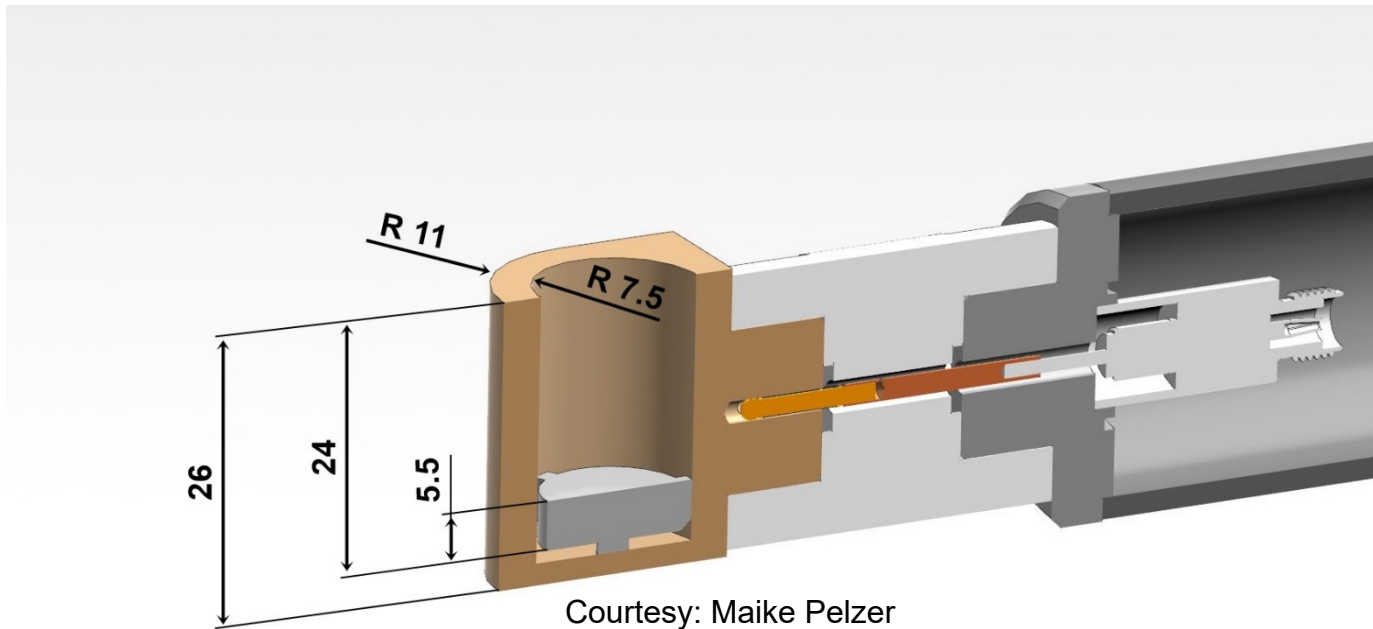

Green=Gammas, Red = Electrons

Courtesy: Sergey Stokov, Gero Kube



# Faraday Cup

## Simulations of former designs used at DESY

If you have other geometries...

- existing Faraday Cup variants at DESY
- Simulated for 5 MeV beam (ARES)
- Variants of materials (Copper - Aluminum combinations)
- Different geometries and angles of electron beam
- Between 4 - 22% of primary and secondary electrons escape from the Faraday Cup
- → **not sufficient for ARES**

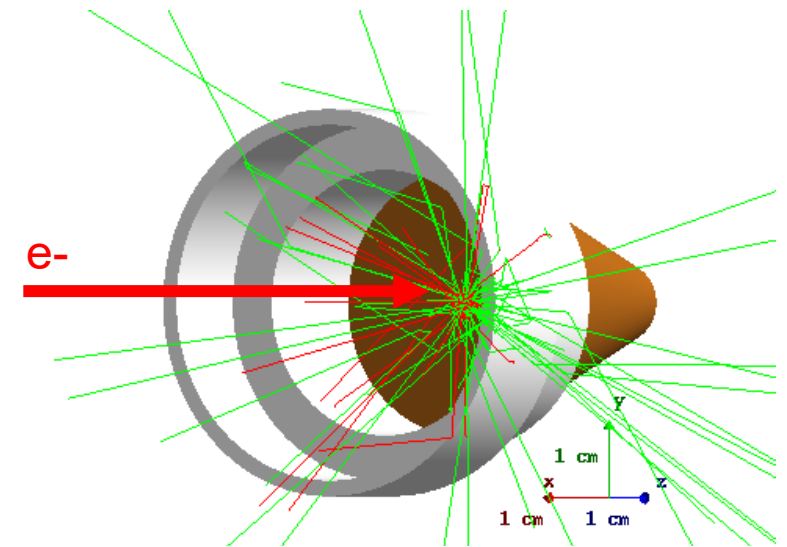
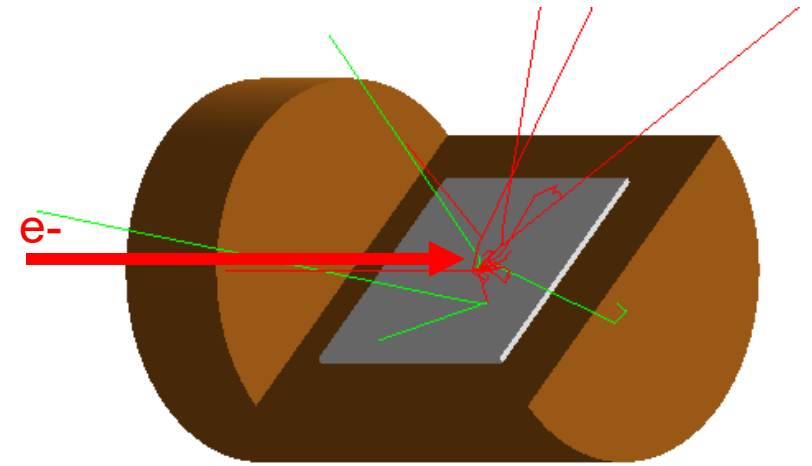

electrons  
gammas

Courtesy: Sergey Stokov, Gero Kube

# Faraday Cup

## Final design

- Faraday Cup mounted on a Mover
- Without cooling due to low repetition rate (10 Hz)
- Screen at same position to check beam size + position

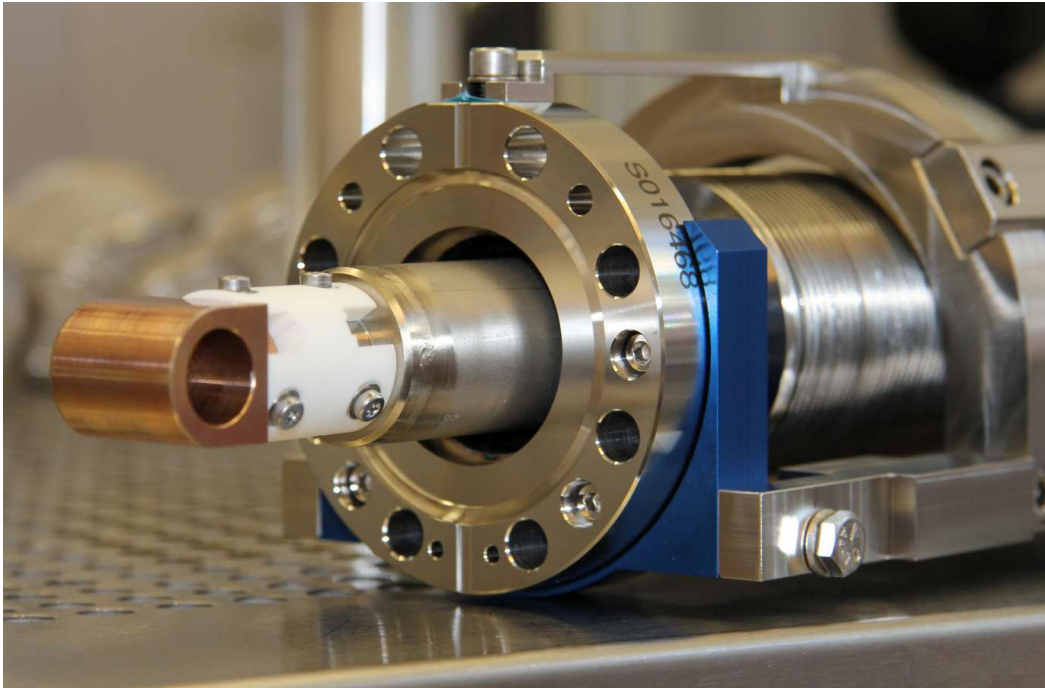

Courtesy: Maike Pelzer (FC), Christian Wiebers (Mover), Juergen Kruse (Support)

Tunnel installation with Faraday Cup horizontal,  
Screen vertical

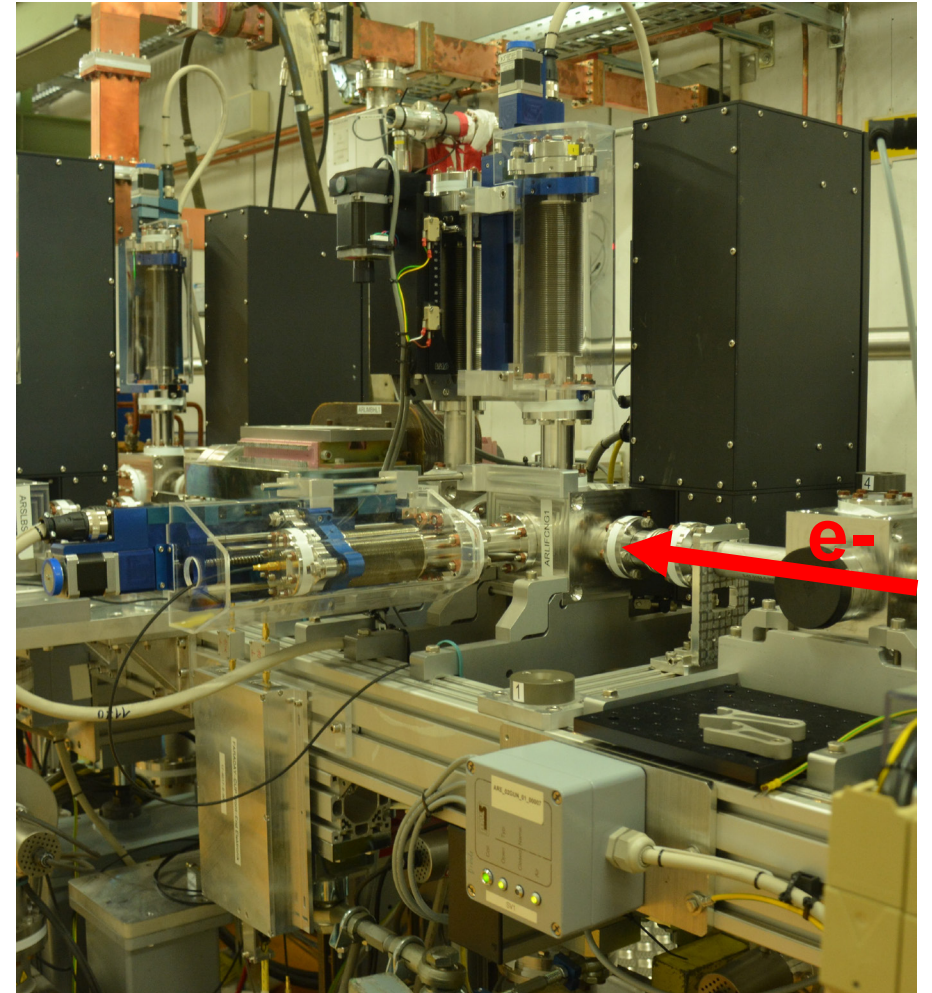

# Faraday Cup

## Electronics and Calibration

- FC signal connected to front end with 15 MHz low pass filter and pre amp (tunnel)
- Read out with MTCA system (outside tunnel)
  - Struck ADC SIS8300-L2D, 16 bit, 125 MS/s
  - *Pulse-form-fit with 3-point sampling*

## Calibration

- Send electrical pulse to the FE electronic
- Corresponds to 1nC pulse
- Scaling the read out

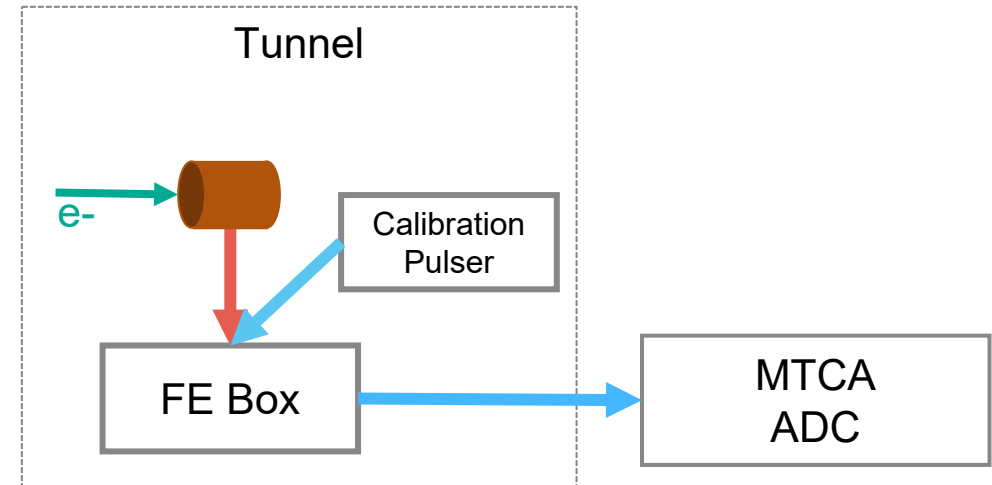
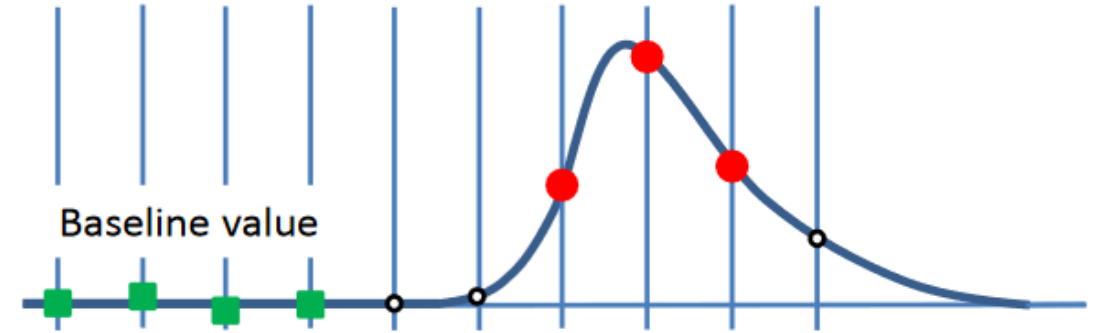

# 03 Beam Charge Transformer (Toroid)

# Toroid

## Optimization of existing Beam Charge Transformers

- E-XFEL and FLASH design (4.5 MHz bunch frequency)
- Ceramic gap with one or dual core, easy half-shell installation (i.e. service w/o opening vacuum)
- Four separate coils, one winding each, concatenated outside (red)
- Front end box with 15 MHz low pass filter and pre amp (tunnel)
- Read out with MTCA system (outside tunnel)
  - Struck ADC SIS8300-L2D, 16 bit, 125 MS/s
  - *Pulse-form-fit with 3-point sampling* (like at FC)

## Calibration

- Send electrical pulse to calibration winding (blue)
- Corresponds to 1nC pulse
- Scaling the read out

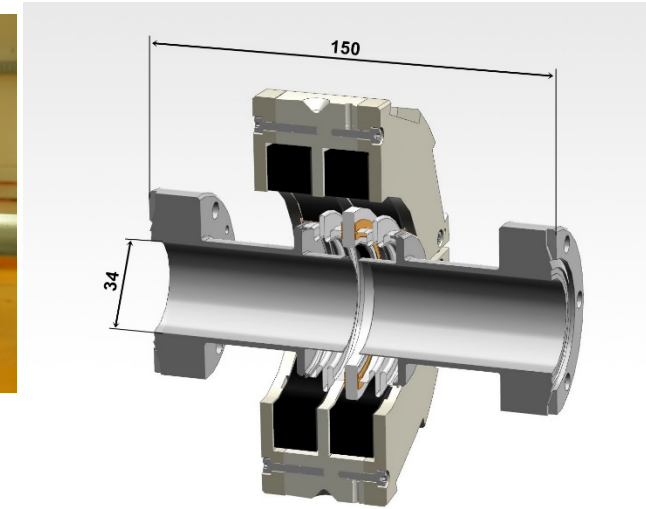
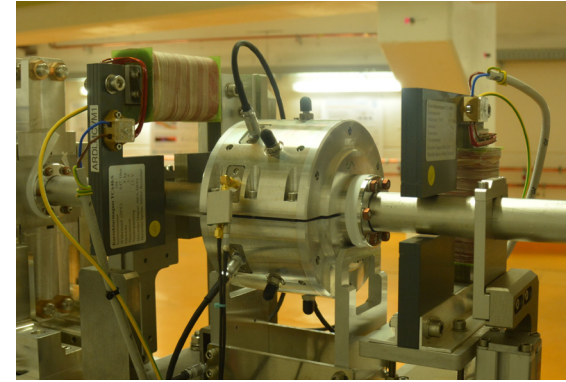

Courtesy: Maïke Pelzer

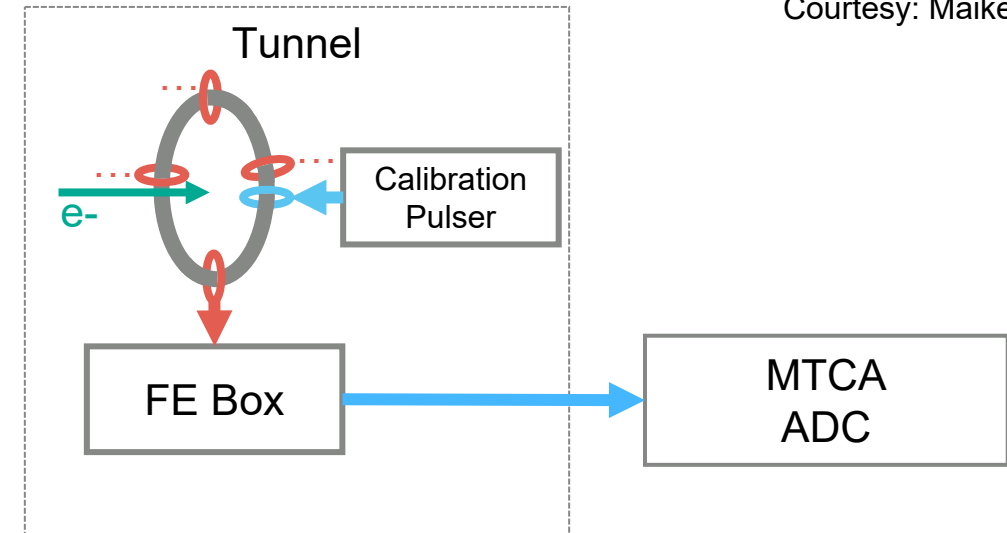



# 04 Dark Current Monitor (DaMon)

# Dark Current Monitor (DaMon)

Invented to measure dark current of accelerators with 1.3 GHz acceleration frequency

- Consists of stainless steel resonator  $TM_{010}$  mode at 1.3 GHz, loaded quality factor about 200, results in bandwidth of about 6 MHz and decay time 50 ns
- RF Front End Electronic (RFFE) with two channels:
  - dark current (DC) with local oscillator, down conversion and logarithmic detector
  - Charge (Q) with logarithmic detector
- Send to MTCA system with 16 bit ADC (Struck 8300-L2D)

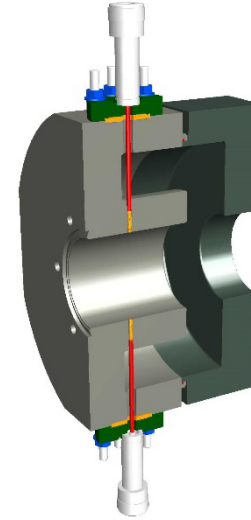

Refs: Lipka et al. DIPAC 2011 WEOC03 and IBIC 2013 WEPF25

# Dark Current Monitor (DaMon)

## Calibration

- For 3 GHz accelerator (ARES) both channels (DC and Q) are used for charge measurement: increase dynamic range
- Arbitrary Waveform generator (AWG) in laboratory simulates output of DaMon
- AWG as input for the RFFE at largest possible amplitude range
- Output of RFFE connected to ADC and monitors amplitude
- Results in an electronics response function look-up table
- Together with measured properties of each individual resonator (frequency, quality factors) and cable attenuation results in look-up table for each channel

Poster TUP037 by Dirk Lipka this afternoon

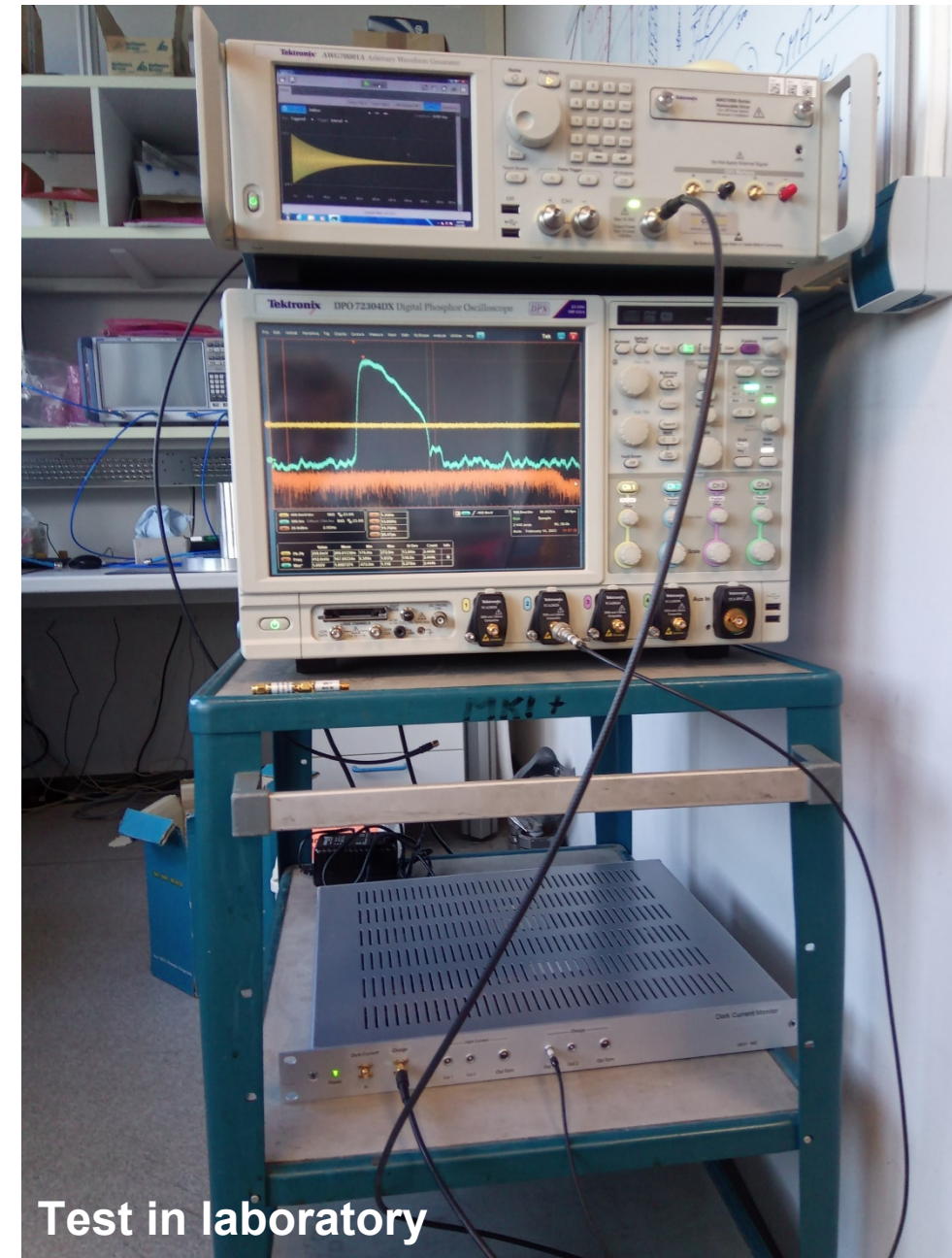

Test in laboratory



# Dark Current Monitor (DaMon)

## Calibration

- For 3 GHz accelerator (ARES) both channels (DC and Q) are used for charge measurement: increase dynamic range
- Arbitrary Waveform generator (AWG) in laboratory simulates output of DaMon
- AWG as input for the RFFE at largest possible amplitude range
- Output of RFFE connected to ADC and monitors amplitude
- Results in an electronics response function look-up table
- Together with measured properties of each individual resonator (frequency, quality factors) and cable attenuation results in look-up table for each channel

Poster TUP037 by Dirk Lipka this afternoon



# 05 Turbo-ICT (Bergoz)



# Bergoz Turbo-ICT

## Integrating Current Transformer + Front end Filter (Bergoz)

### Turbo-ICT in vacuum

- BERGOZ Turbo-ICT and BCM-RF-E (outside tunnel, ~30m cable)
  - Use in Sample & Hold Mode
  - Range: 50 fC ... 300 pC
  - Noise: 10 fC rms or 1% of charge (whichever is higher)
- Connected to a KEITHLEY High Resolution DVM (DMM7510)
  - Resolution 1  $\mu$ V (at range 10 V)
  - Ethernet for control system read out
- Triggering
  - 10 Hz trigger from timing system
- Apply Look-up-Table in Software with data from Bergoz' calibration

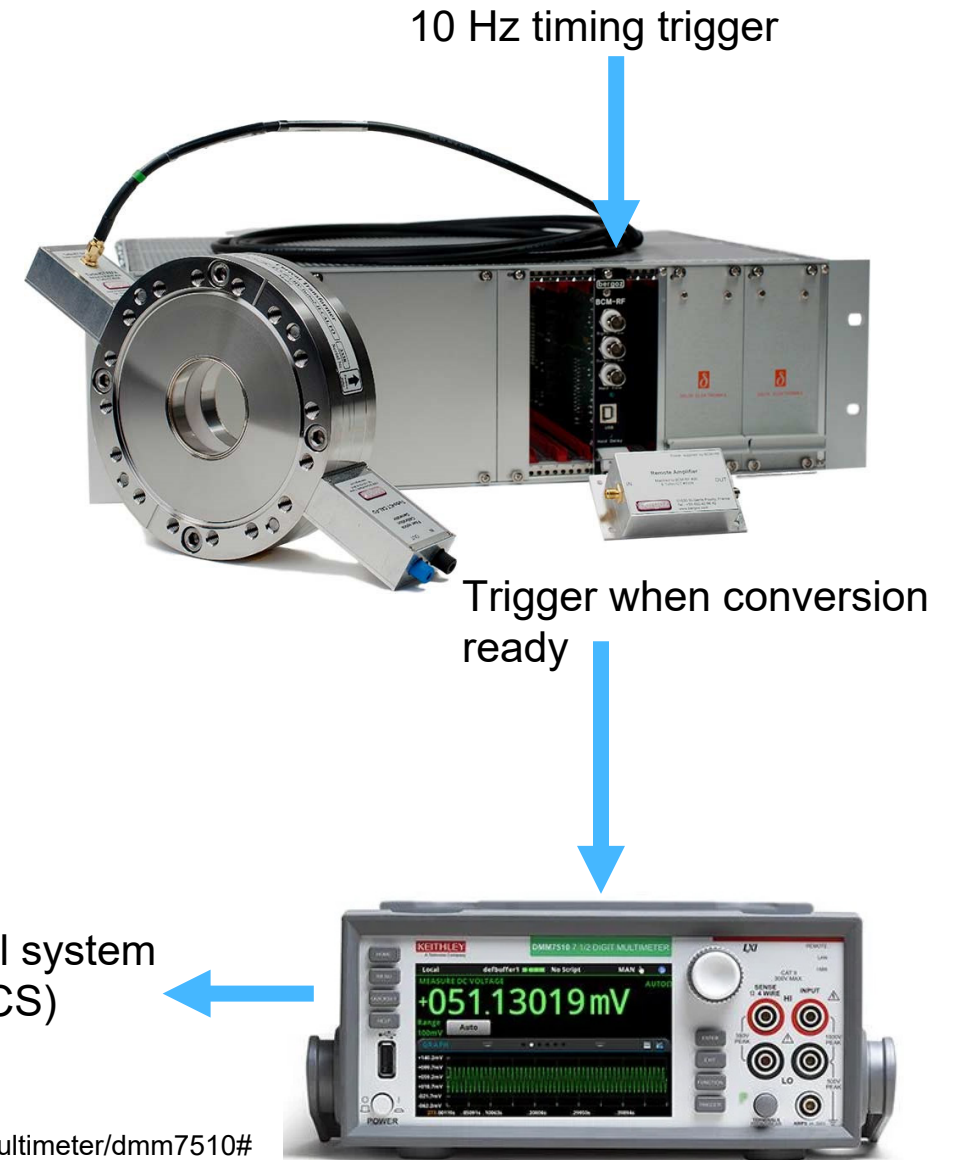

<https://www.bergoz.com/products/turbo-ict/>  
<https://www.tek.com/de/products/keithley/digital-multimeter/dmm7510#>

# 05 ICT (Bergoz)

# Bergoz ICT in air

## Improvised installation for testing purposes

### In-air ICT

- Placed after a window outside the end of beam pipe (~30 cm after T-ICT)
- Read-out, integration and scaling with 12 bit scope
- Can easily be moved to other DESY machines

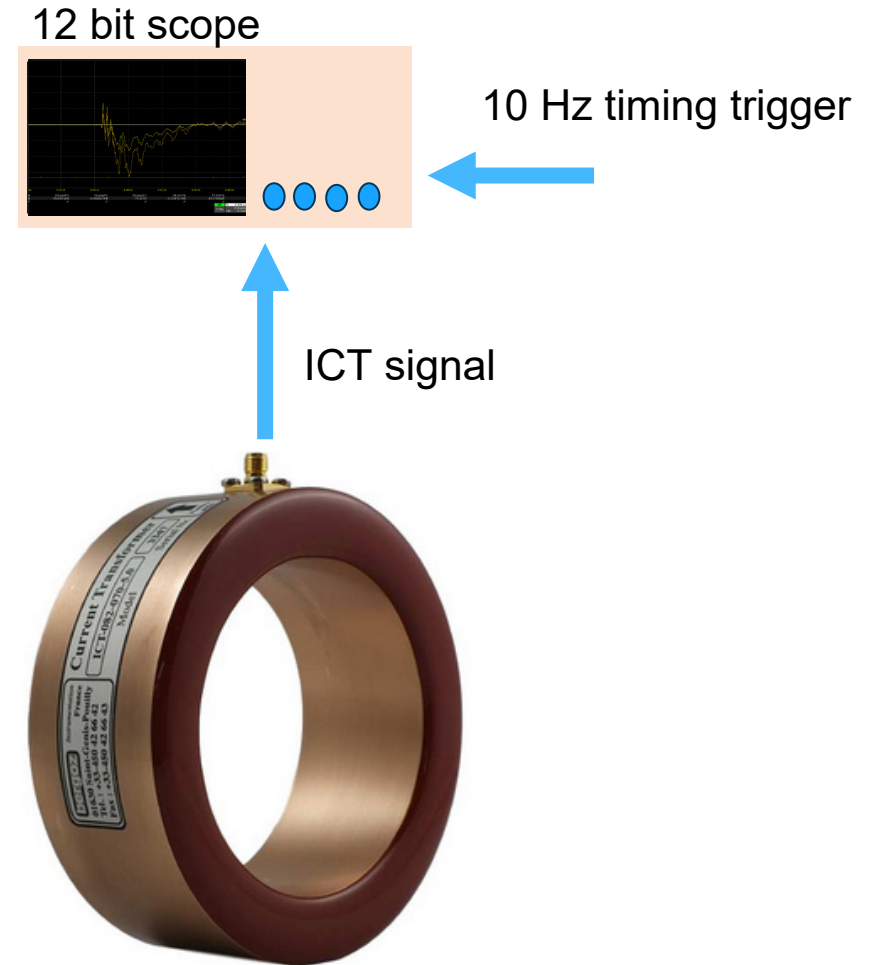
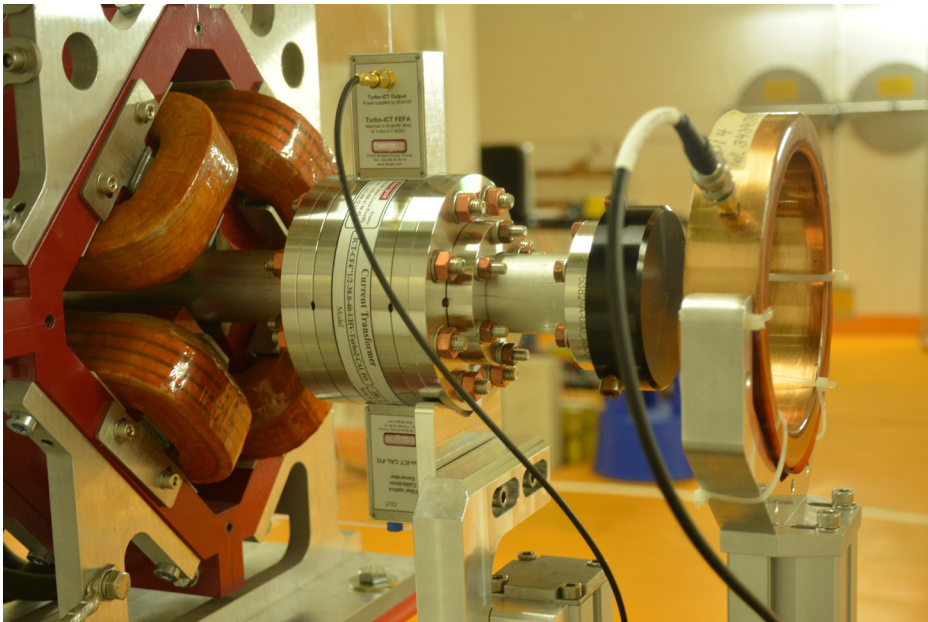

<https://www.bergoz.com/products/ict/>

# 06 Measurements

# What has been measured?

- ARES at 10 Hz rep rate
- Charge Sweep from 0.1 – 153 pC
- ~100% Beam Transport (w/o Bunch Compressor and X-Band TDS)
- 500 values per charge from each monitor saved synchronously
  
- Output will be plots of ...
  - Linearity of each monitor compared to Faraday Cup (w/o uncompensated losses [0.6% simulation])
  - Resolution of each monitor



# DaMon DC vs. Faraday Cup

Range 0.1 – 13 pC

	DaMon DC0	DaMon DC1
Linear fit slope	1.04	1.06
Linear fit offset	-0.002 pC	-0.006 pC

- Calibrated in the lab, not beam based
- Measure  $\sim <20$  pC only
- Error is standard deviation caused by beam charge jitter (relative plot)

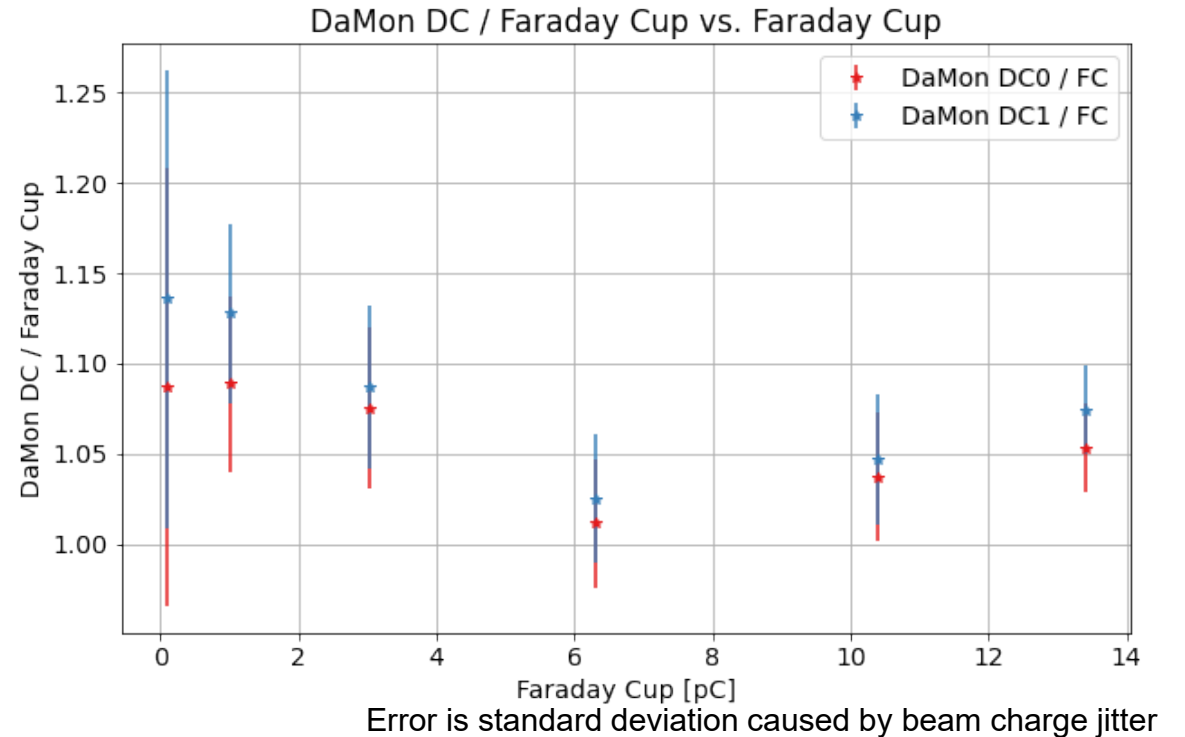
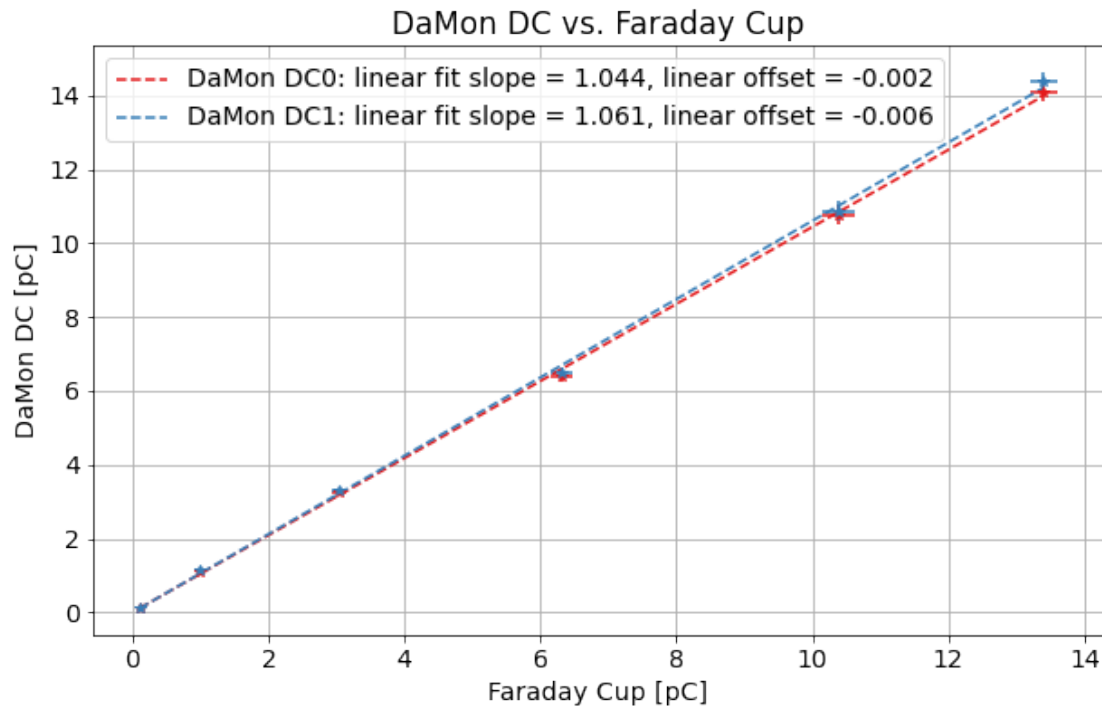

# DaMon Q vs. Faraday Cup

Range 1 – 153 pC

	DaMon Q0	DaMon Q1
Linear fit slope	0.96	1.04
Linear fit offset	0.26 pC	0.31 pC

- Calibrated in the lab, not beam based

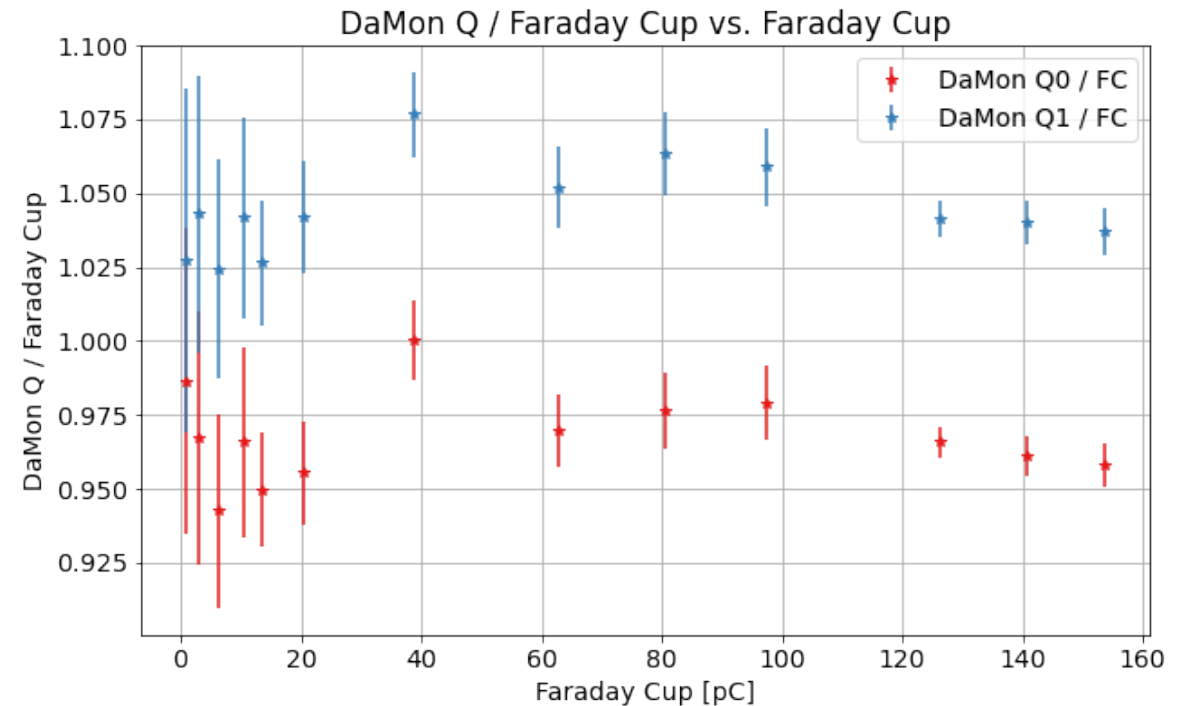
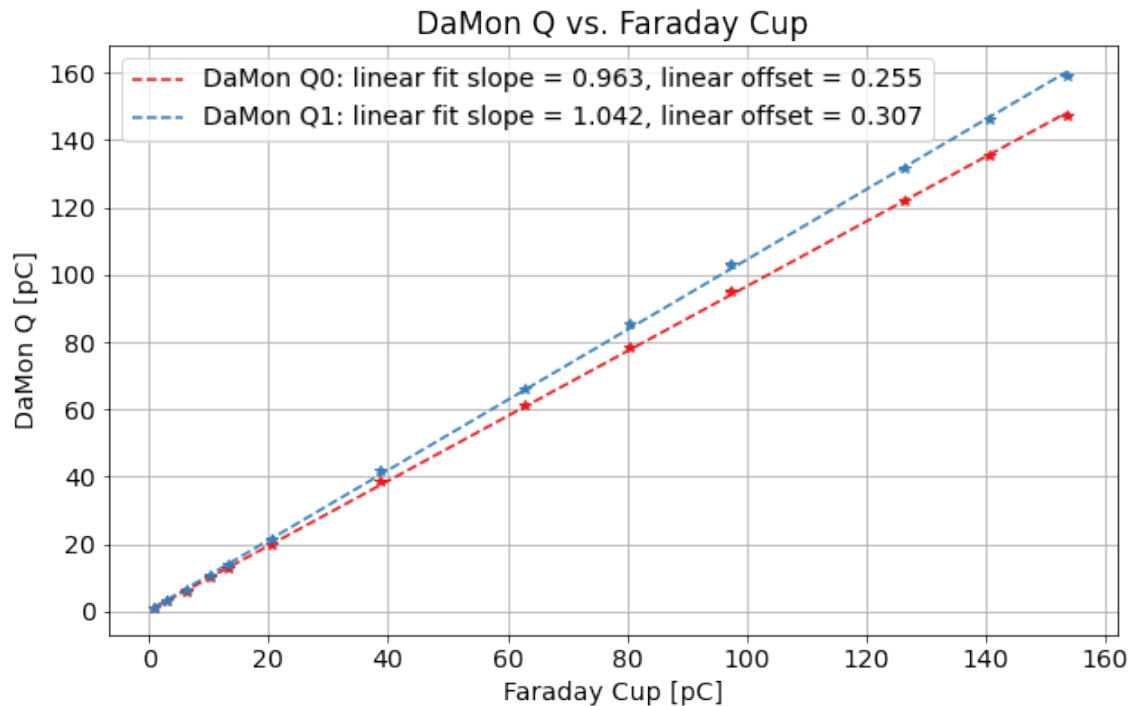

Error is standard deviation caused by beam charge jitter

# Toroid vs. Faraday Cup

Range 1 – 153 pC

	Toroid0	Toroid1
Linear fit slope	1.18	1.15
Linear fit offset	-0.02 pC	-0.02 pC

- Calibrated with 1nC pulse
- Calibration scheme seems to be not matched as expected  
→ under investigation
- ... but linear

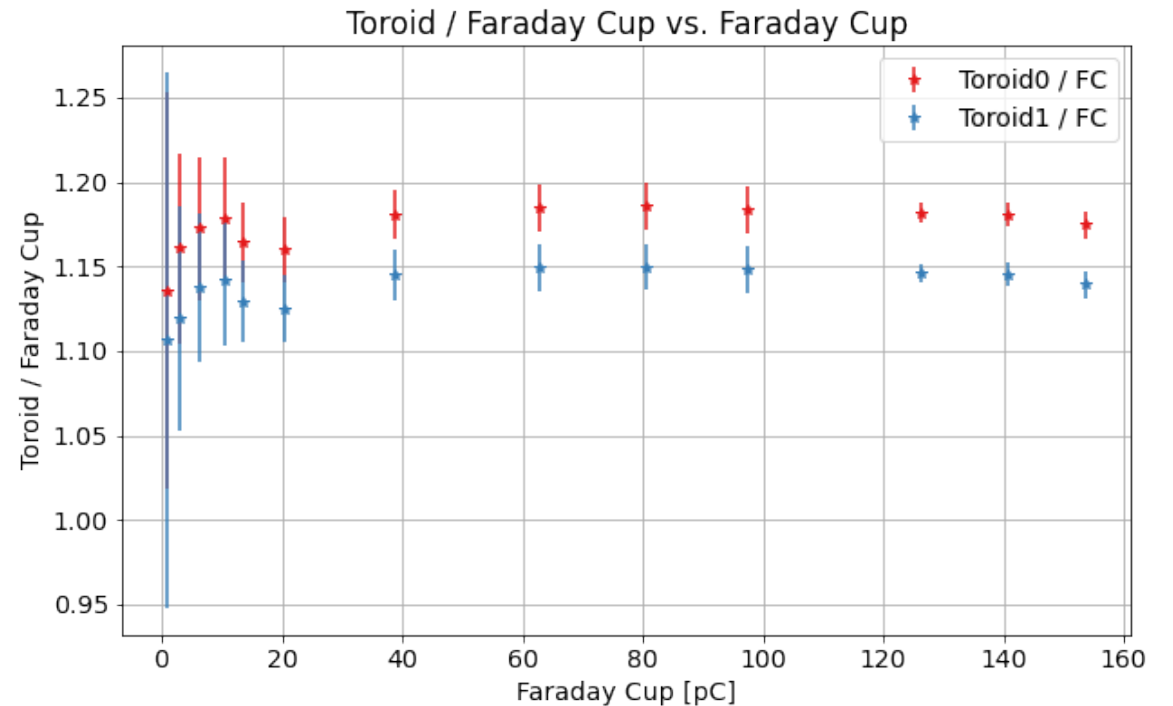
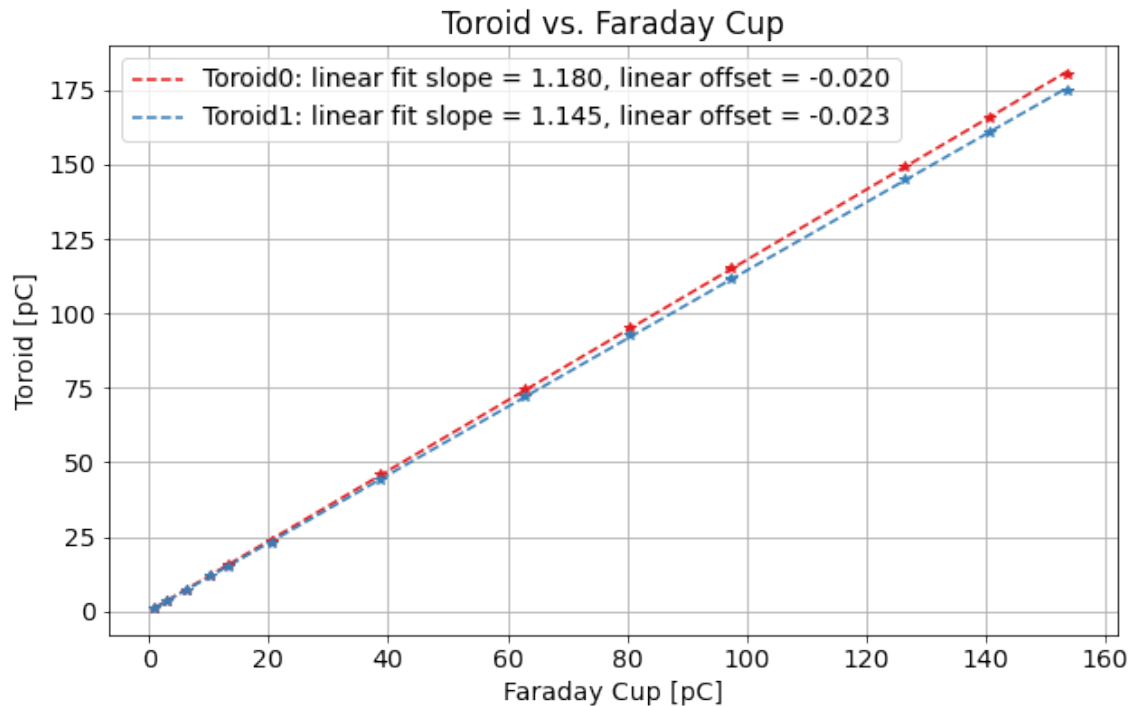

Error is standard deviation caused by beam charge jitter

# Bergoz Turbo ICT vs. Faraday Cup

Range 1 – 153 pC

	T-ICT
Linear fit slope	1.012
Linear fit offset	0.11 pC

- Calibrated at Bergoz
- Implemented look up table

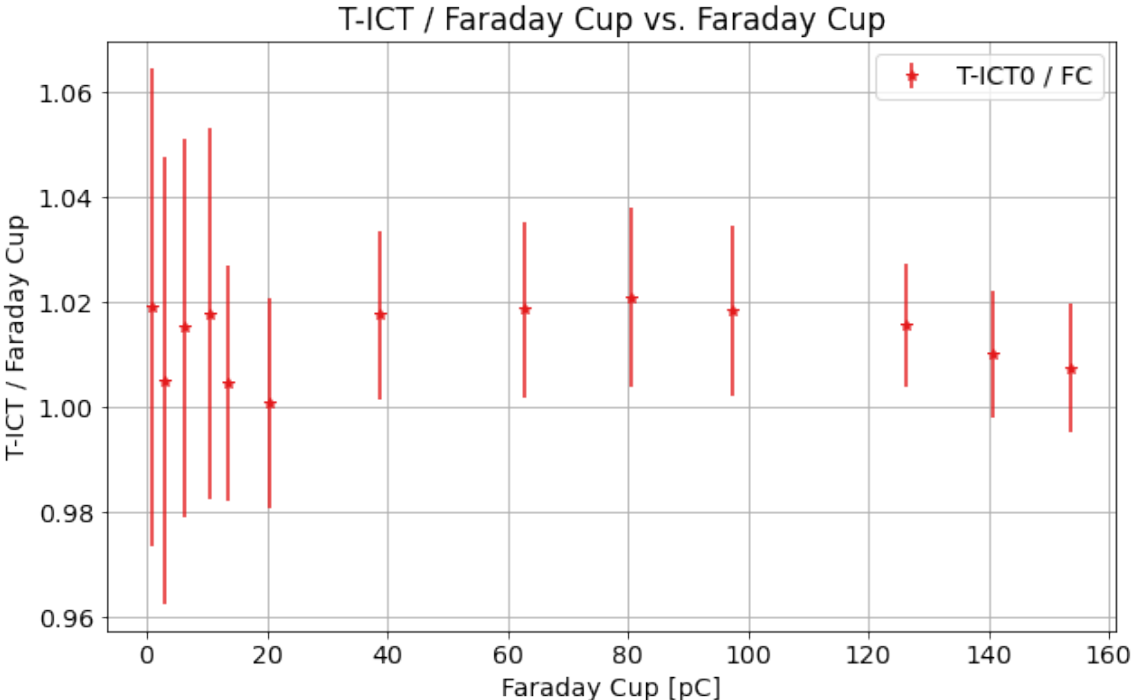
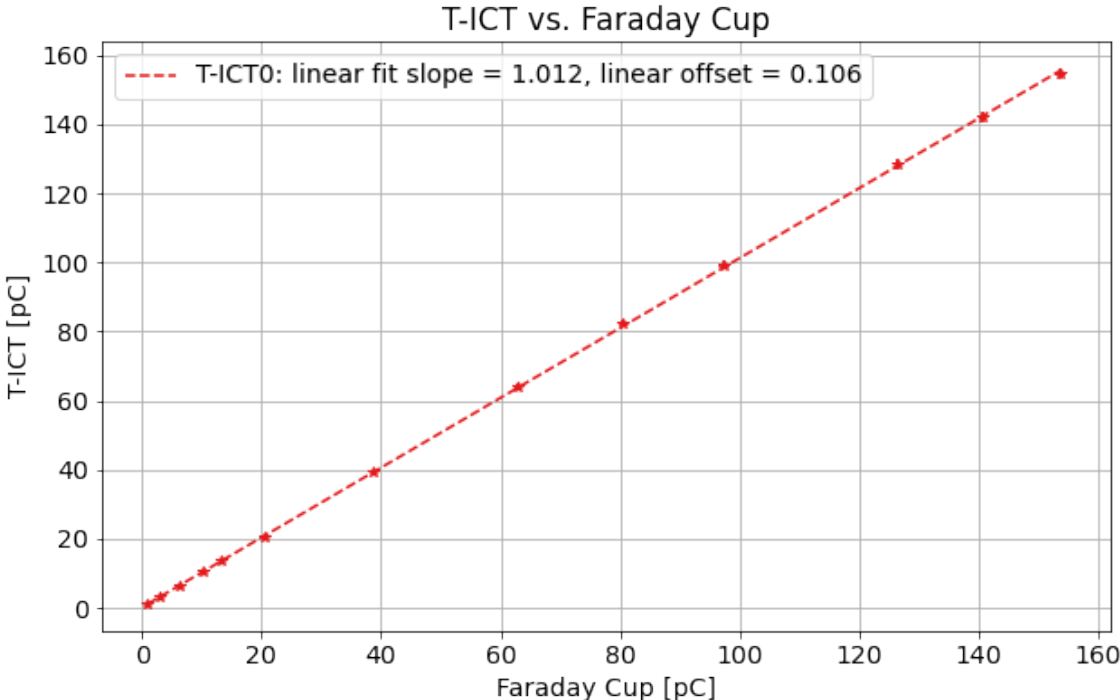

Error is standard deviation caused by beam charge jitter

# Bergoz ICT in Air vs. Faraday Cup

Range 30 – 153 pC

	ICT
Linear fit slope	1.03
Linear fit offset	5.9 pC

- Calibrated at Bergoz
- Read out with 12 bit scope
- Values <30 pC not measurable in the current scheme (cable ...)
- not fully trustworthy due to improvised read out → Ongoing work

ICT in air vs. Faraday Cup

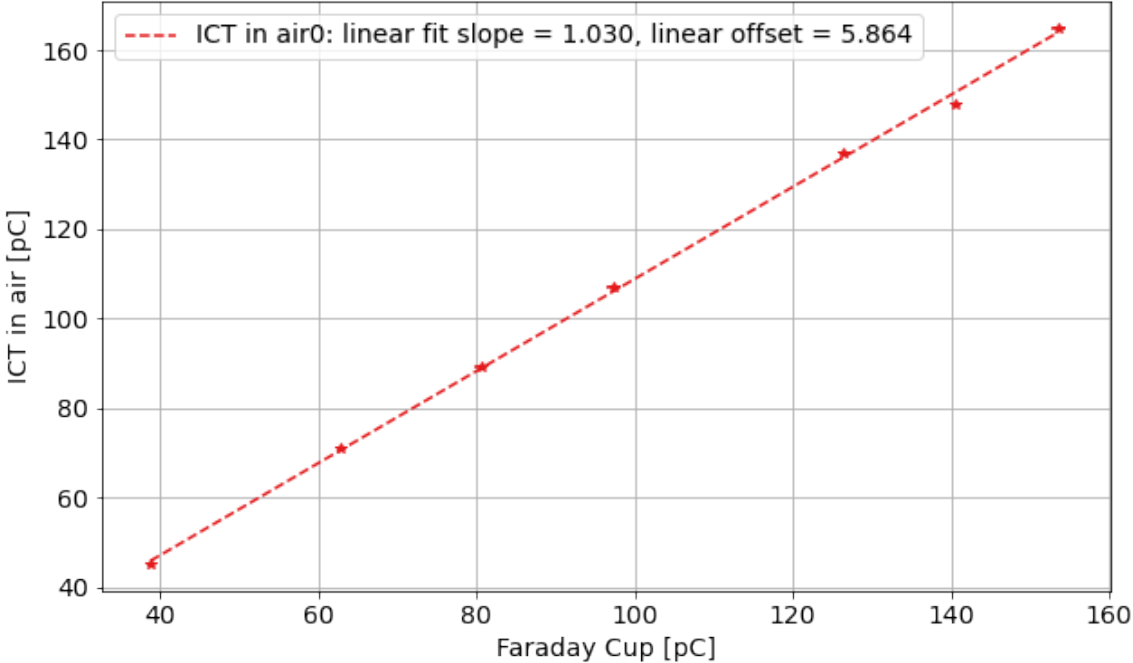

ICT in air / Faraday Cup vs. Faraday Cup

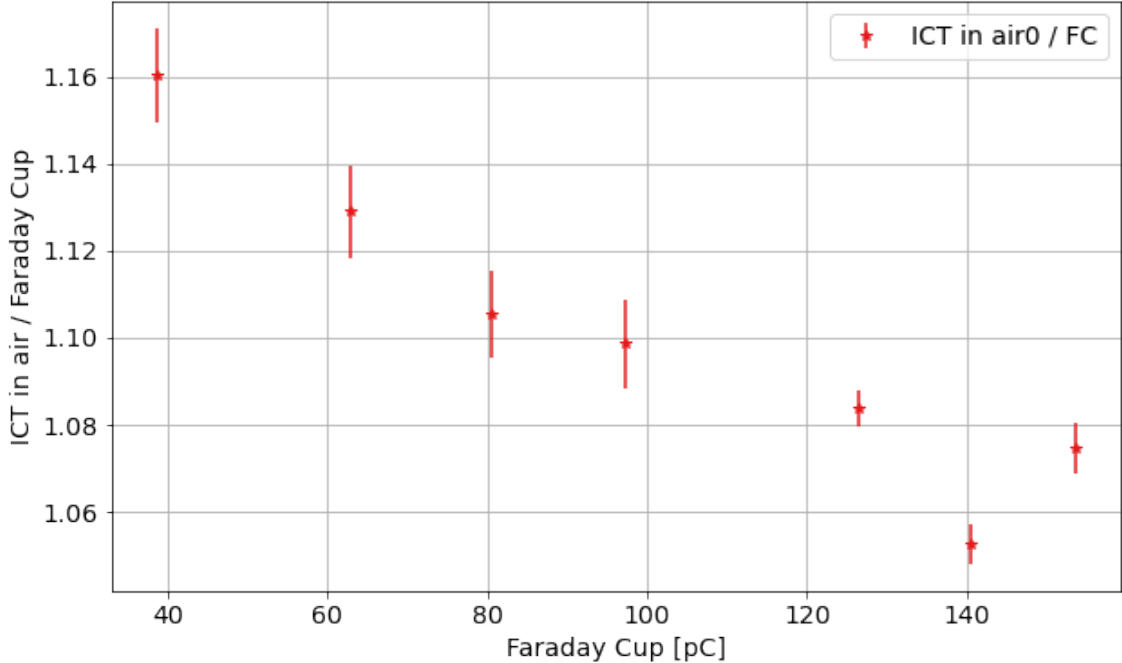

Error is standard deviation caused by beam charge jitter



# Resolution Measurement

## Use standard deviation (rms) to calculate resolution

- Take all non-destructive charge monitors synchronously per charge step as reference value
- Compare monitor under test to the reference value
- Independent from machine optics
  
- We included Cavity BPM charge channel data to enhance the reference value
  
- Details of this procedure:
  - „Resolution Studies at Beam Position Monitors at the FLASH Facility at DESY“, N.Baboi, BIW2006

# Resolution of DaMon DC Channel

Charge range from 0.1 – 13 pC

100 fC – 13 pC	DaMonDC0	DaMonDC1
Resolution [fC]	4 – 111	4 – 90
Resolution [%]	3.4 – 0.83	3.36 – 0.59

- DaMon DC Channels limited to <20 pC
- Very good at <10 pC

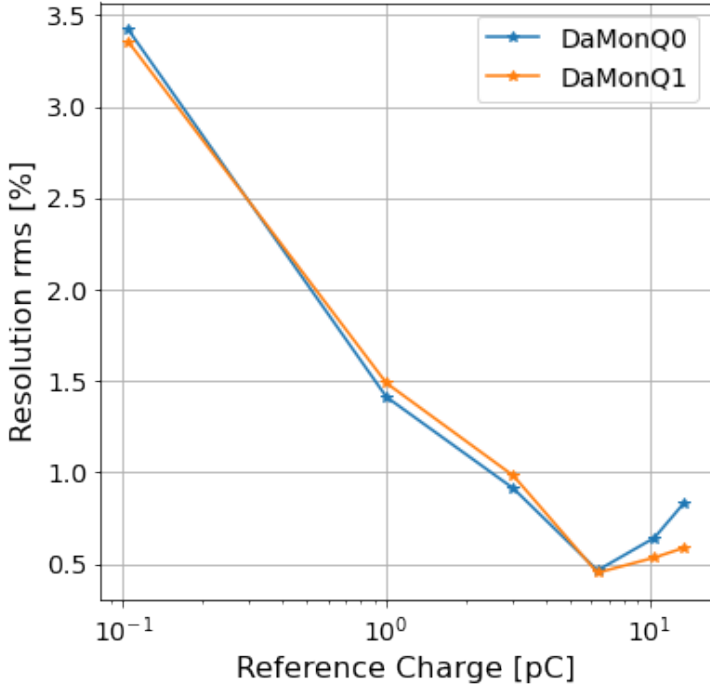
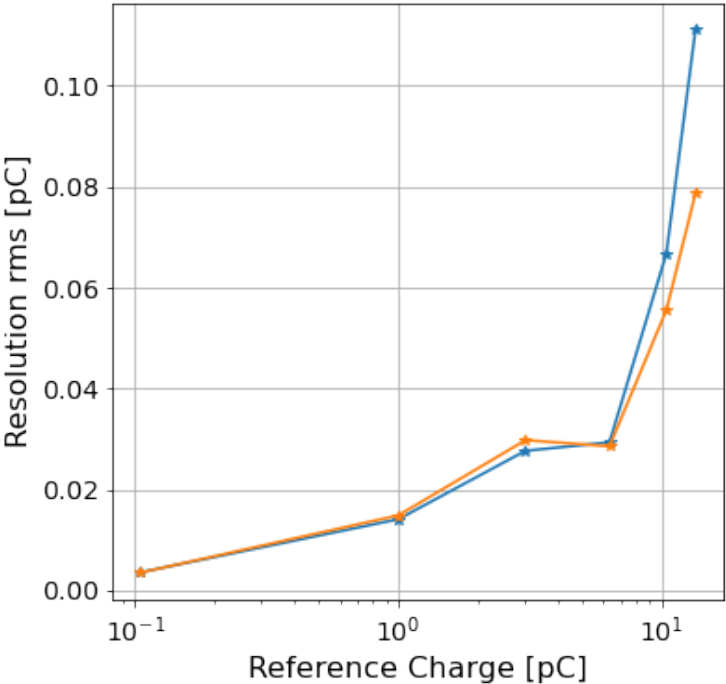

# Resolution of DaMon Q Channel

Charge range from 1 – 153 pC

1 pC – 153 pC	DaMonQ0	DaMonQ1
Resolution [fC]	34 – 366	37 – 427
Resolution [%]	3.38 – 0.24	3.74 – 0.28

- For high charges resolution converges to <0.3%

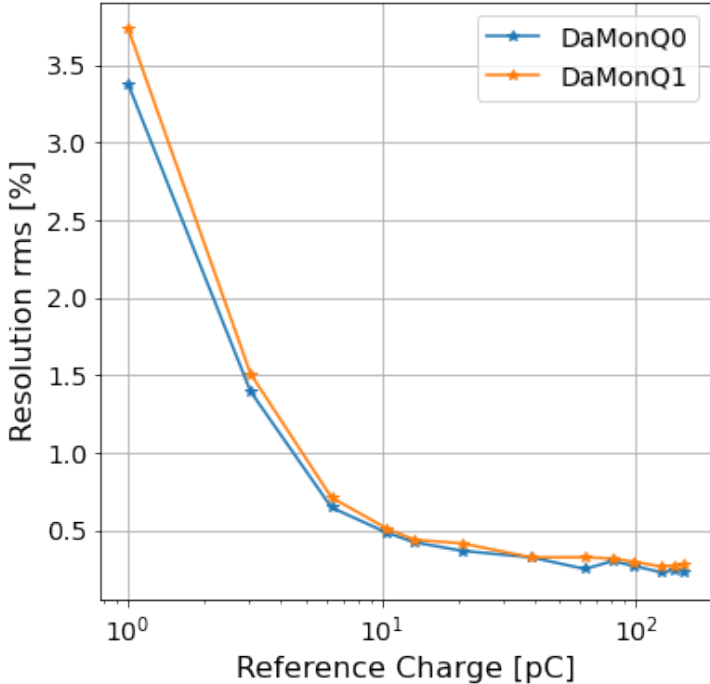
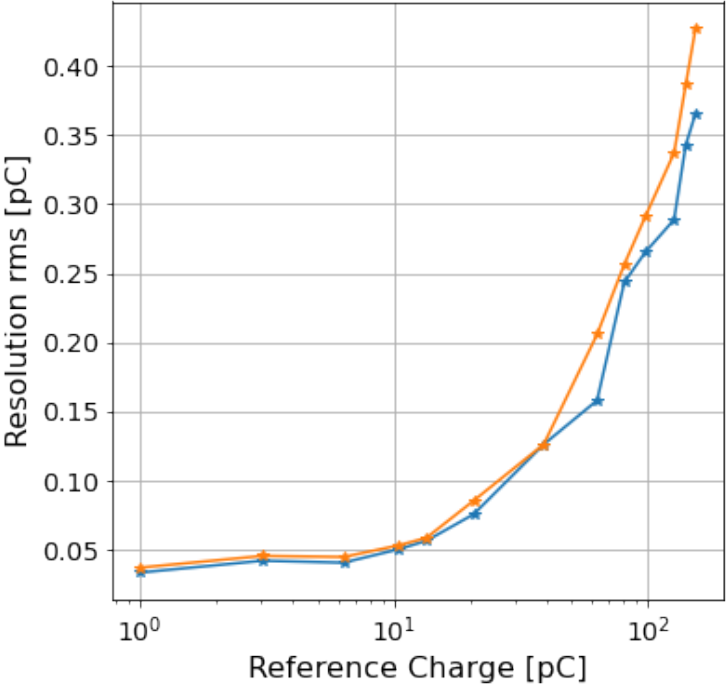

# Resolution of Toroid

Charge range from 1 – 153 pC

1 pC – 153 pC	Toroid0 (dual core)	Toroid1 (single core)
Resolution [fC]	108 – 119	151 – 154
Resolution [%]	10.8 – 0.08	15.08 – 0.1

- For high charges resolution converges to 0.1%

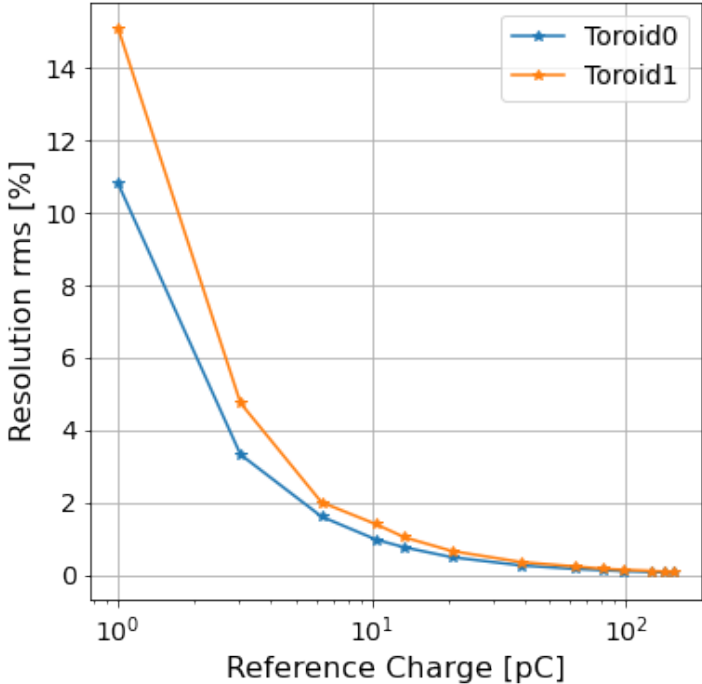
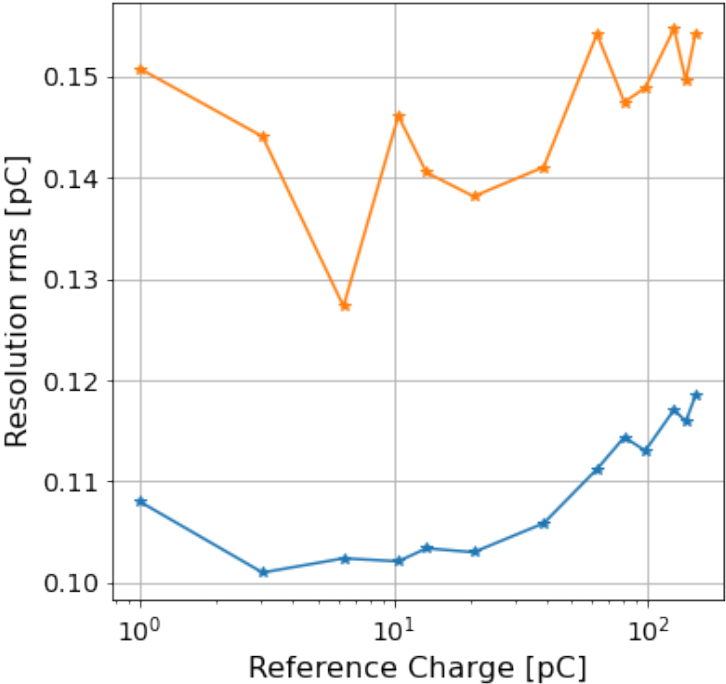

# Resolution of T-ICT

Charge range from 1 – 153 pC

- For high charges resolution converges to ~1%
- Resolution value larger due to extended cable (~30m) (expected 10 fC @5m cable)

1 pC – 153 pC	T-ICT
Resolution [fC]	31 – 1621
Resolution [%]	3.08 – 1.06

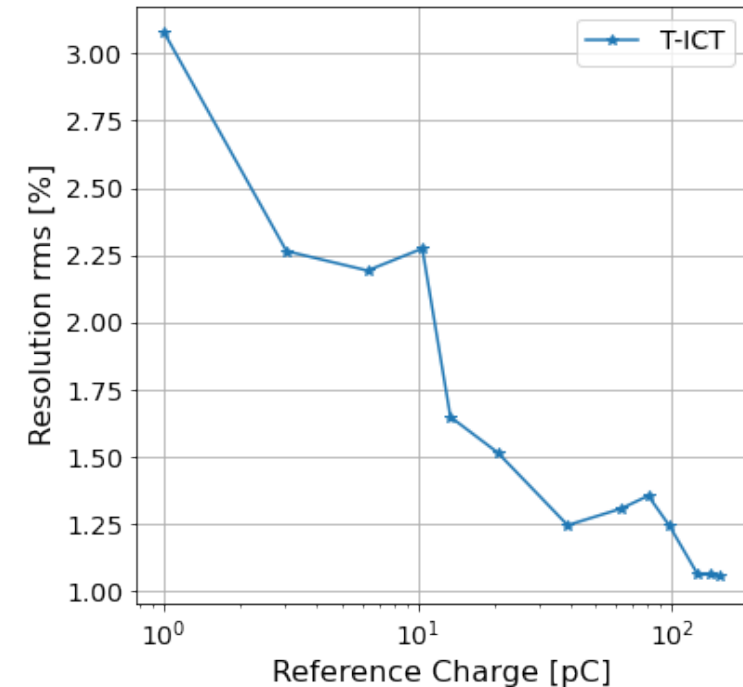
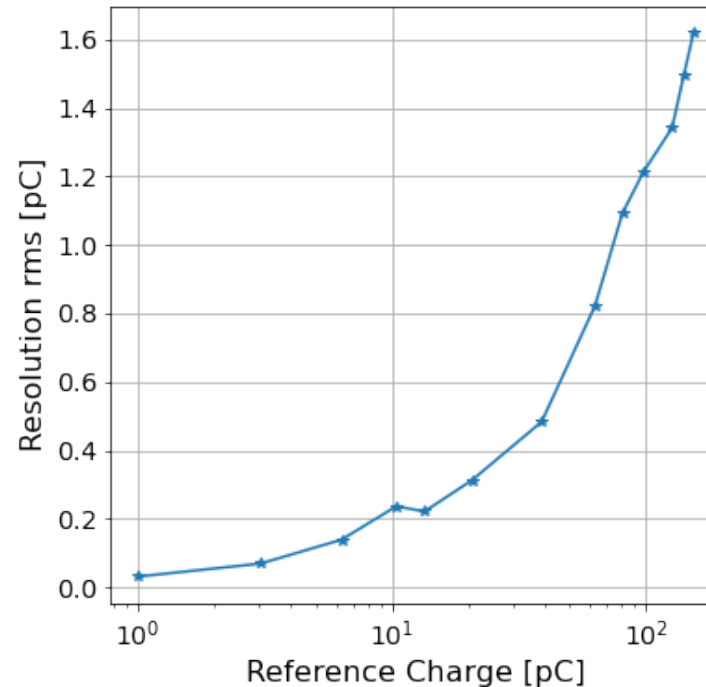



# Compare Resolution

If we want to do a ranking ...

- DaMonDC:  $\leq 6$  pC
- DaMonQ: 6 – 60 pC
- Toroids:  $>60$  pC Toroids best resolution
- T-ICT:
  - also good for  $<1$  pC
  - used for absolute values

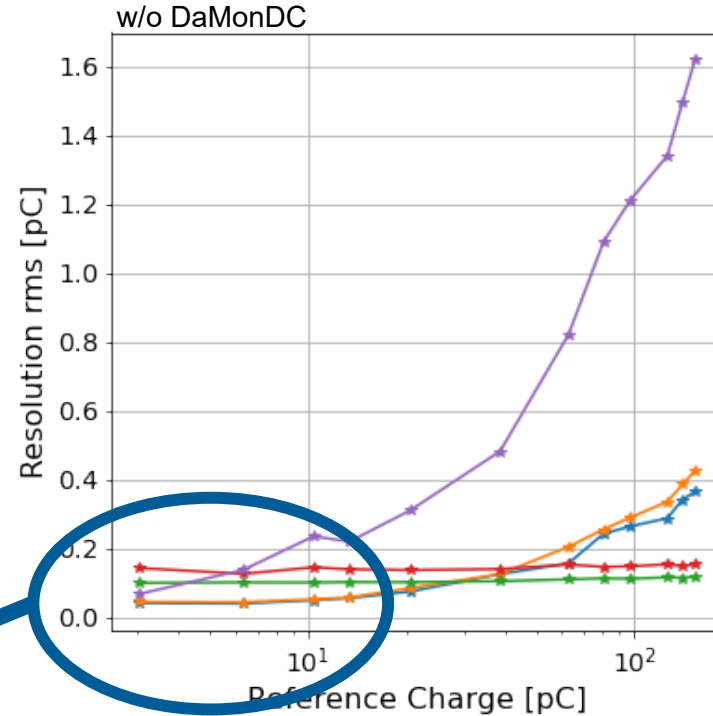
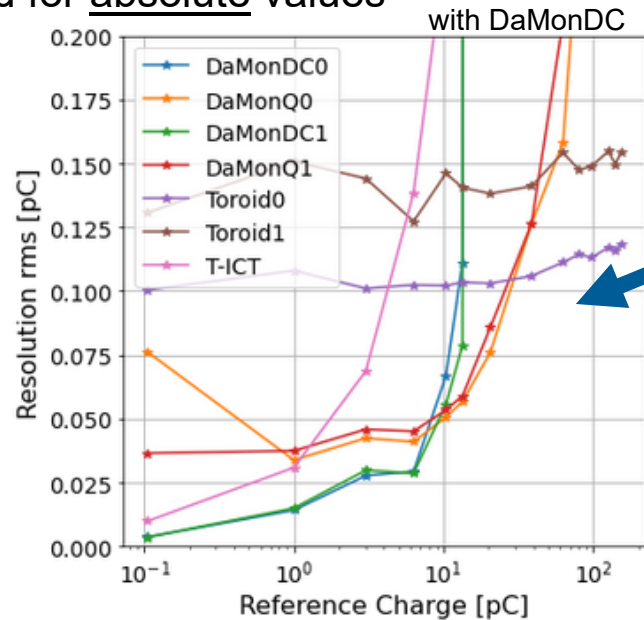

Legend colors differs!

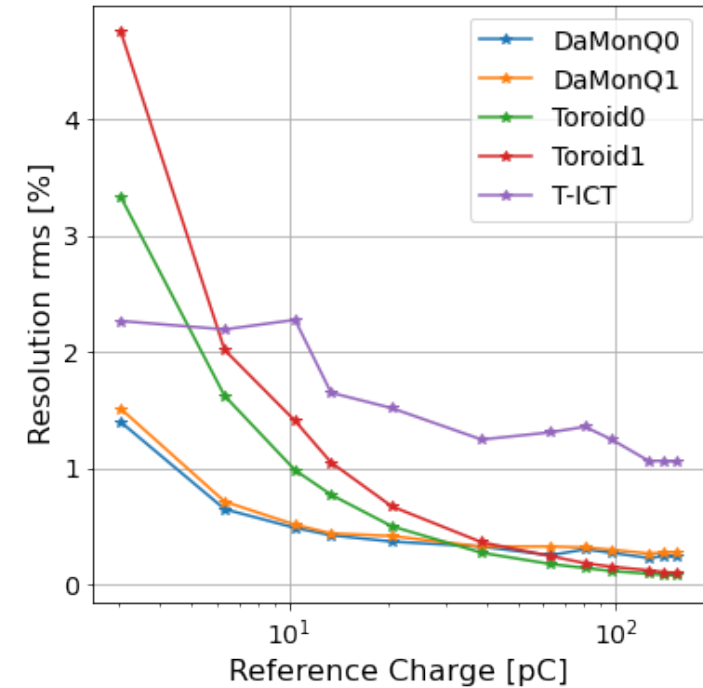

# 07 Summary

# Summary

## Linearities and Resolutions of all monitors @ARES

	DaMon DC	DaMon Q	Toroid	T-ICT	ICT
Measurement range [pC]	0.1 to 13	1 to 153	1 to 153	1 to 153	38 to 153
Linear fit Slope	1.04 1.06	0.96 1.04	1.18 1.15	1.01	1.03
Linear fit Offset [pC]	-0.002 -0.006	0.26 0.31	-0.02 -0.02	0.11	5.9
Resolution rel. (min/max charge)	3.4% to 0.8% 3.3% to 0.6%	3.4% to 0.2% 3.7% to 0.3%	10.8% to 0.1% (Dual core) 15.1% to 0.1% (Single core)	3.1% to 1.1%	not accessible
Use for	Resolution $\leq 6$ pC	Resolution 6 – 60 pC	Resolution $>60$ pC	Absolute measurement	<i>take-away-ref</i>

- ICT measurement not to be taken as face value yet

# Summary

- Four different types of charge monitors, 1 destructive, 4 non-destructive installed in ARES
- New simulated Faraday Cup design, catches >99% of charged particles
- DaMons show very good results compared to Faraday Cup
- Toroids show 15-18% linear slope deviation, but linear with good resolution at higher charges
- T-ICT also shows very good agreement with Faraday Cup → absolute measurement
  
- Except ICT all monitors are used for machine operation
- Outlook: improve ICT read out and Toroid calibration

# Thank you



12<sup>th</sup> INTERNATIONAL BEAM  
INSTRUMENTATION CONFERENCE  
SASKATOON, CANADA  
September 10-14, 2023



**Many people contributed to development, installation, commissioning and measurements**

**From the ARES team**

Florian Burkhart, Willi Kuroпка, Hannes Dinter, Frank Mayet, Max Kellermeier, Sonja Jaster-Merz

**From Diagnostics Group (MDI)**

Maike Pelzer, Jürgen Kruse, Norbert Wentowski, Zlatan Pizarov, Klaus Knaack, Artem Novokshonov, Jörg Neugebauer, Sergey Stokov, Christian Wiebers, Bastian Lorbeer, Hans-Thomas Duhme, Igor Krouptchenkov, Jorgen Lund-Nielsen<sup>†</sup>

## References

- F. Burkart, R.W. Aßmann, H. Dinter, S. Jaster-Merz, W.Kuroпка, F. Mayet, and et al., "The ARES Linac at DESY", in Proc. LINAC'22, Liverpool, UK, Aug.-Sep. 2022, pp. 691-694. doi:10.18429/JACoW-LINAC2022-THPOJO01  
<https://www.picmg.org/openstandards/microtca>  
<https://www.struck.de/sis8300-l2.html>
- M. Werner et al., "A Toroid Based Bunch Charge Monitor System with Machine Protection Features for FLASH and XFEL", in Proc. IBIC2014, Monterey, CA, USA, 2014, pp. 521–524.
- M. Werner et al., "Sensitivity Optimization of the Standard Beam Current Monitors for XFEL and FLASH II", in Proc. DIPAC2011, Hamburg, Germany, 2011, pp. 197–199.
- D. Lipka et al., "Charge Measurement with Resonators at ARES", in Proc. IBIC2023, Saskatoon, CA, September 2023, paper TUP037, these proceeding this conference
- K. B. Unser, "Measuring bunch intensity, beam loss and bunch lifetime in LEP", Report CERN-SL-90-27-BI", 1990, <https://cds.cern.ch/record/209858>
- N. Baboi et al., "Resolution Studies at Beam Position Monitors at the FLASH Facility at DESY", in Proc. BIW'06, Batavia, IL, USA, May 2006, AIP Conf. Proc., vol. 868, pp. 227–237. doi:10.1063/1.2401409
- B. Lorbeer et al., "Cavity BPM Electronics for SINBAD at DESY", in Proc. 11th Int. Beam Instrum. Conf. (IBIC'22), Kraków, Poland, Sep. 2022, pp. 413–415. doi:10.18429/JACoW-IBIC2022-WEP14