

IBIC 2023



The Art of Sensing Orbits in Mile-Long Accelerators on a Nanometer Scale

Danny Padrazo

Date 9/10/23

ID: MO3I01



Overview

- Today's RFBPM Electronics at NSLS-II
 - Typical Cell Configuration
- RF BPM Development- Motivation
 - RF BPM Upgrade (Next-Generation Receiver)
- RF BPM development Time-Line
- RF BPM Evolution
 - Generation 2 Digital Front End/BPM
 - zDFE- Zynq FPGA
 - Generation 3 Digital Front End/BPM
 - zuDFE- Zynq Ultra-Scale FPGA
 - Generation 2 Analog Front End/BPM
 - Analog Devices Dual ADC LTC2195
 - Generation 3 Analog Front End/BPM
 - Texas Instrument Dual ADC ADS54J69
 - Generation 3 Digital Front End (rfSOC)/BPM
 - ZCU208
- Summary/Look-Ahead

Today's RF BPM Electronics at NSLS-II

- Successfully developed an “In-House” solution for High Performance Beam Position Monitor
- Approximately 300 units in service since 2010
- Benefits realized by “In-House” System Design
 - ✓ Organizational expertise to support a development program
 - ✓ Flexibility to Implement State-of-The Art Technologies
 - ✓ Utilize capabilities for hardware, software, and firmware development
 - ✓ Innovative techniques for production, fabrication, assembly, test, and integration
 - ✓ Independent of 3rd-party / proprietary platform
 - ✓ Significant cost-savings compared to commercial options
 - ✓ Adaptation to the growing needs of Accelerator Physics initiatives
 - ✓ **Investment for the future!**

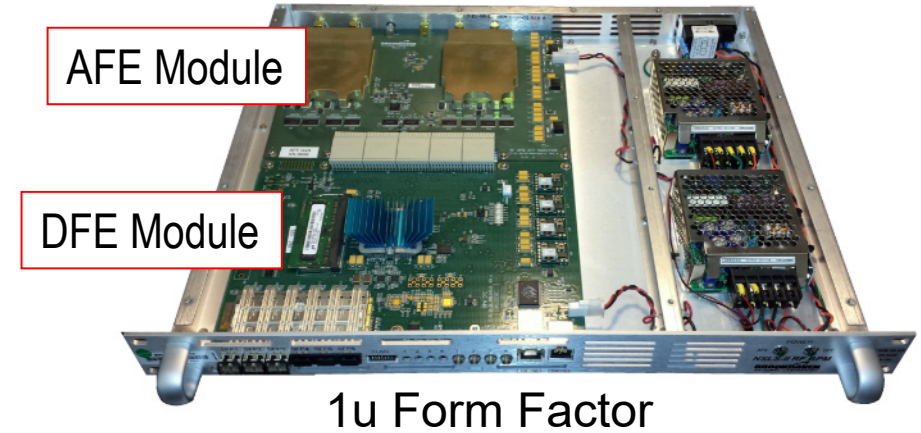

- Meets Performance Specifications including:
 - ✓ 1 um in 378Khz (TbT)
 - ✓ 200 nm in 10 kHz (FA)
 - ✓ Long Term Stability 200nm/8hrs in 10Hz (SA)
 - ✓ Verified with beam
- TbT (Turn By Turn) used for injection & kicked beam studies
- FA (Fast Acquisition) for fast orbit feedback & interlocks
- SA (Slow Acquisition) for orbit measurements, System Health
- No bunch-by-bunch capability (cannot resolve bunches within a turn)

Data Type	Mode	Max Record Length
ADC Data	On-demand	256Mbytes or 32M samples raw ADC per channel simultaneously
TbT	On-demand	256Mbytes or 5M samples TbT (Frev=378KHz)
FOFB 10KHz	Streaming via SDI Link and On-demand	Streaming - X,Y,SUM ; For On-Demand: 256Mbytes or 5M samples FA (10KHz)
Slow Acquisition 10Hz	Streaming	DDR3 80hr Circular Buffer SA (10Hz)
System Health	Streaming 10Hz	DDR3 80hr circular buffer System Health; AFE temp, DFE temp, FPGA Die temp, PLL lock status, SDI Link status

Typical BPM Cell Configuration

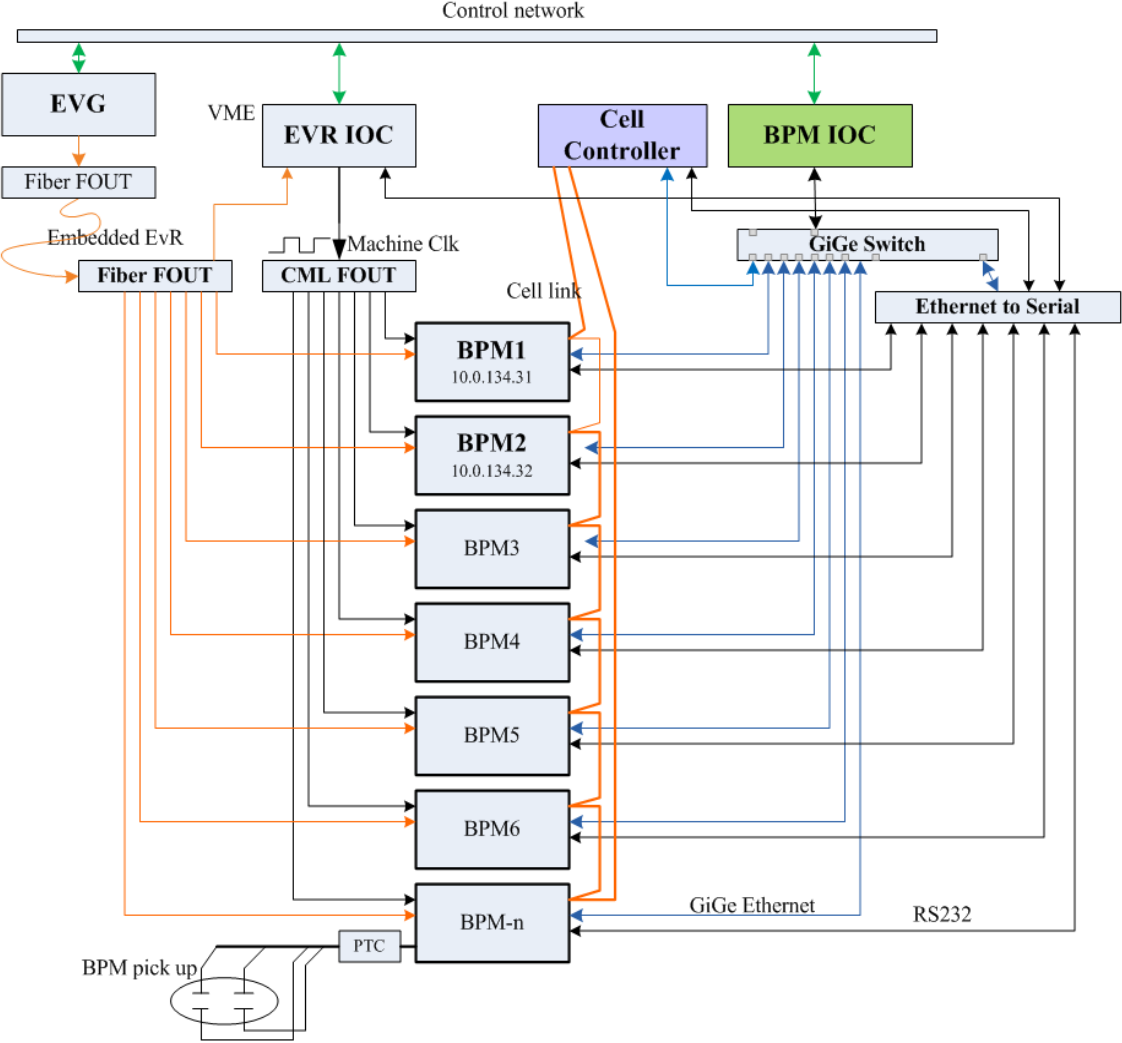

Temperature Controlled Racks

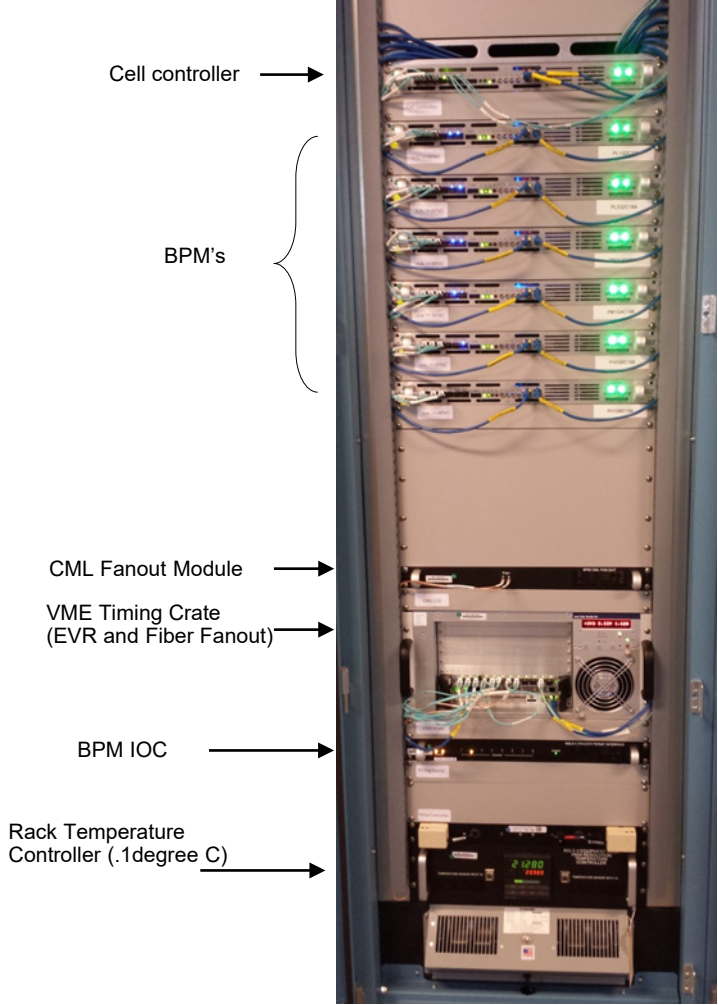

RF BPM Development- Why Upgrade?

➤ Motivation

- ✓ Growing Demands
Maintain the status of NSLS-II as a World-Class Facility
- ✓ Obsolescence
System is 10 years old and Replacement parts are no longer available.
- ✓ Provide a Path to supporting the growing needs of NSLS-II and Beyond!

➤ Target Improvement Goals

- ✓ Long Term Stability **200nm → 50nm** (10Hz(SA))
- ✓ Resolution **200nm -> 50nm** (10Khz(FA))
- ✓ Reliability
Mitigate Incident of failure
- ✓ Stability
Provision of on-board temp control for RF input chain to **.001degree C** (Heat Pump)

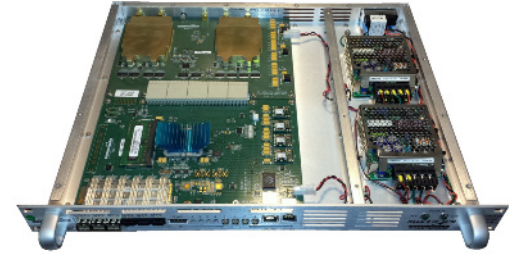

V6DFE, GEN1 AFE BPM



zDFE, GEN1 AFE BPM

RF BPM Development- The Future is Here!

➤ Available Features for next generation BPM:

- ✓ More advanced signal processing routines for accelerator physics applications.
 - ✓ Unlimited Record length for TbT, FA, SA Data Types
 - ✓ Gating Function, extract any bunch from 1320 fill (2 -> 8 gates)
 - ✓ Photon Feed Back Integration
- ✓ Faster ethernet communication
- ✓ Embedded EPICS IOC
- ✓ LINUX Operating System
- ✓ Resources to implement active calibration
- ✓ Serve as a common processing platform for the XBPM, Cell Controller and other sub-system applications.
- ✓ Analog Front End options with higher sampling rates, implementation of an RF switching matrix
- ✓ Bunch to Bunch resolution
- ✓ Precision on-board temperature control for each RF input chain

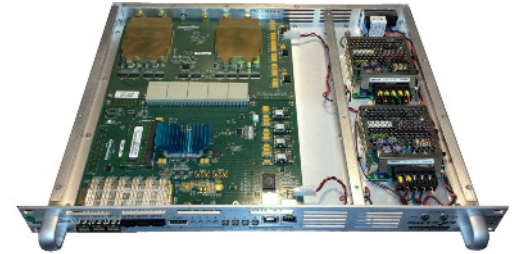

V6DFE, GEN1 AFE BPM



zDFE, GEN1 AFE BPM

RF BPM Development- Time Line

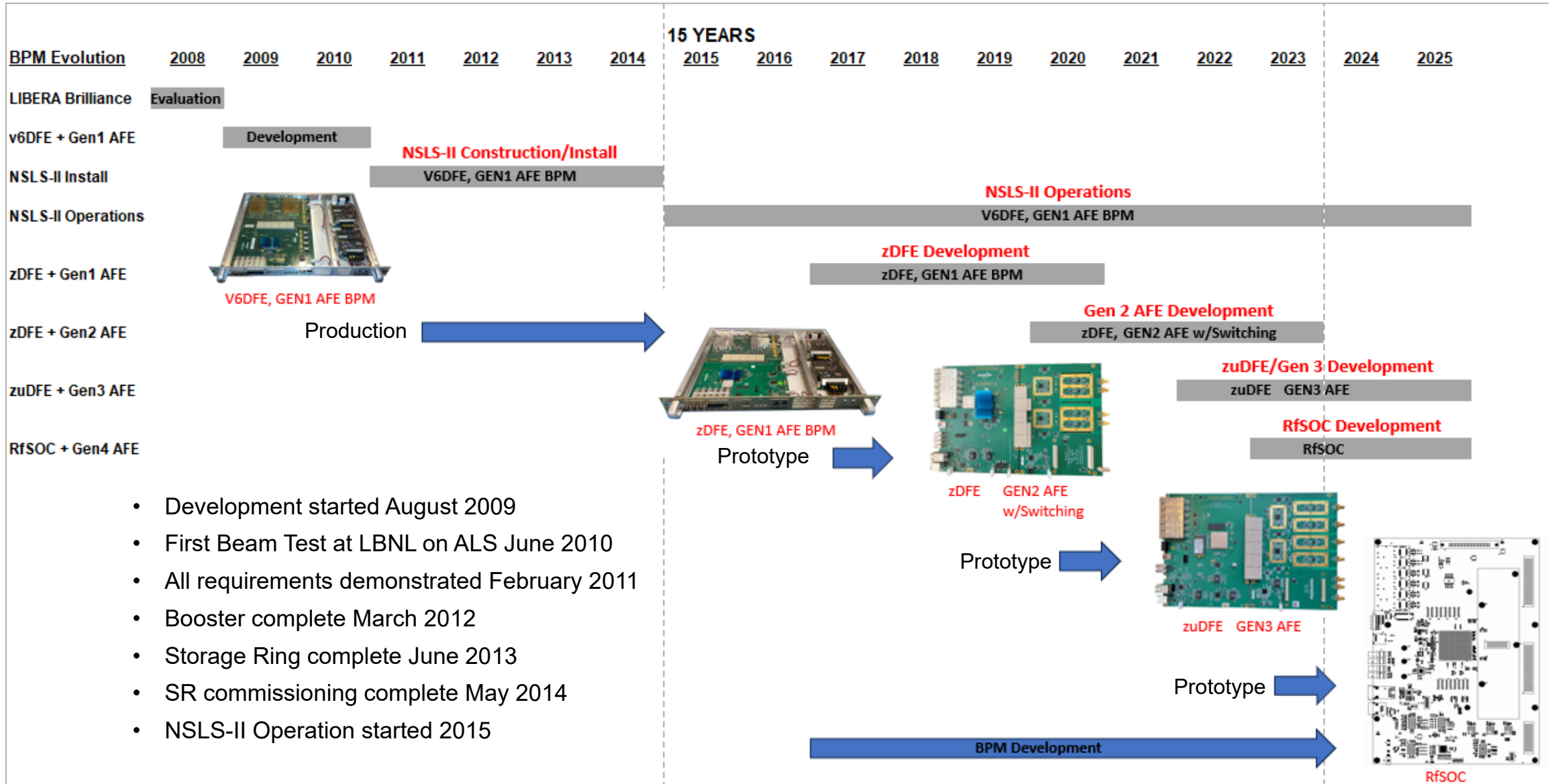

- Development started August 2009
- First Beam Test at LBNL on ALS June 2010
- All requirements demonstrated February 2011
- Booster complete March 2012
- Storage Ring complete June 2013
- SR commissioning complete May 2014
- NSLS-II Operation started 2015

RF BPM Development/Evolution

We Are Here

RF BPM Development Road Map		TIME LINE											
Updated: 8/23		2015		2021				2022		2023		2024	
	v6DFE + Gen1 AFE	ZDFE + Gen1 AFE		ZDFE + Gen2 AFE		ZuDFE + Gen3 AFE		RfSOC + Gen4 AFE		Libera Brilliance +			
Availability	Present/Ops	2021		Q2 2022		Q2 2023		Q2 2024		Present			
Approx Cost (\$K)	6	6		6		8		10		10			
Performance Enhancers													
RF Switching (Macom MASW-00758)	n/a	off	on	off	on	off	on	off	on	off	on		
Temp. Stability Feedback	n/a	n/a	n/a	off	on	off	on	off	on	n/a			
AFE Specs													
ADC Technology	Single	Single		Low Power Dual		Dual		Integrated with FPGA		Dual			
ADC MFG/P/N	AD	AD		AD/LTC2195		TI/ADS54J60		Xilinx		Dual			
ADC Sample Rate (MSPS)	117	117		117		Up to 1000		Up to 5000		117			
TbT Resolution (nm)	1000	1000	n/a	tbd	tbd	tbd	tbd	<200	tbd	tbd	400		
FA Resolution (nm)	200	200	80	tbd	tbd	tbd	tbd	<100	tbd	tbd	100		
SA Resolution (nm)	100	100	5	tbd	tbd	tbd	tbd	<80	tbd	tbd	10		
SA Long Term Stability (nm) (8hrs)	200	200	20	500	15	tbd	tbd	tbd	tbd	tbd	100		
DFE Specs													
FPGA Technology	Xilinx Virtex 6	Xilinx Zynq		Xilinx Zynq		Xilinx Zynq UltraScale+		Xilinx rSOC		Kintex UltraScale+			
Gigabit Ethernet Throughput (Mbps)	2	600		600		1000		1000		500			
FOFB Max Link Speed (Gbps)	5	5		5		10		10		5			
Operating System	Proprietary	Linux		Linux		Linux		Linux		unknown			
Embedded IOC	No	Yes		Yes		Yes		Yes		Yes			
ADC Record Length	1M Samples	8M Samples		8M Samples		16M Samples		16M Samples		16M Samples			
TbT Record Length	2M Samples	2M Samples		2M Samples		Unlimited		Unlimited		4M Samples			
FA Record Length	2M Samples	Unlimited		Unlimited		Unlimited		Unlimited		Unlimited			
SA Record Length	Unlimited	Unlimited		Unlimited		Unlimited		Unlimited		Unlimited			
Gating Function	2	8		8		8		tbd		5			
On-board Non Volatile Memory	32Mbyte	64GByte (sdcard)		64GByte (sdcard)		2Tbyte (M.2 SSD)		2Tbyte (M.2 SSD)		proprietary			
Qualitative Specs													
Open source	yes	yes		yes		yes		yes		no			
Common platform	yes	yes		yes		yes		yes		no			
Local Expertise / Serviceability	yes	yes		yes		yes		yes		no			
FPGA Firmware Customization	yes	yes		yes		yes		yes		rely on vendor			
FPGA Obsolescence	yes	no		no		no		no		no			
HS Temp Control Racks	required	required		not required		not required		not required		not required			
Photon FB integration	yes	yes		yes		yes		yes		unknown			

RFBPM Development Project

Gen-2 Digital Front End (zDFE)

- 2018 Fully Developed Production Gen 2 Zynq Digital Front End (zDFE) board for NSLS-II BPM electronics
- Supports Gen2 (AD) ADC AFE
- In use since 2018, has found many applications besides BPMs for NSLS2.
- Zynq FPGA XC7Z045FF900
 - Hard Dual-Core ARM Cortex A9 Processor
 - 1GB SDRAM
 - 14 – 10 Gbps transceivers
 - 6 SFP
 - 8 via rear connectors
 - 32 Gbyte SDCARD
 - Gigabit Ethernet
 - Si5338 PLL for clocking
 - 4 front panel I/O
 - 8 front panel status LED's
 - 74 LVDS diff pairs to AFE
 - 28 single-ended 3.3v I/O
 - Runs Ubuntu 20.04 Linux

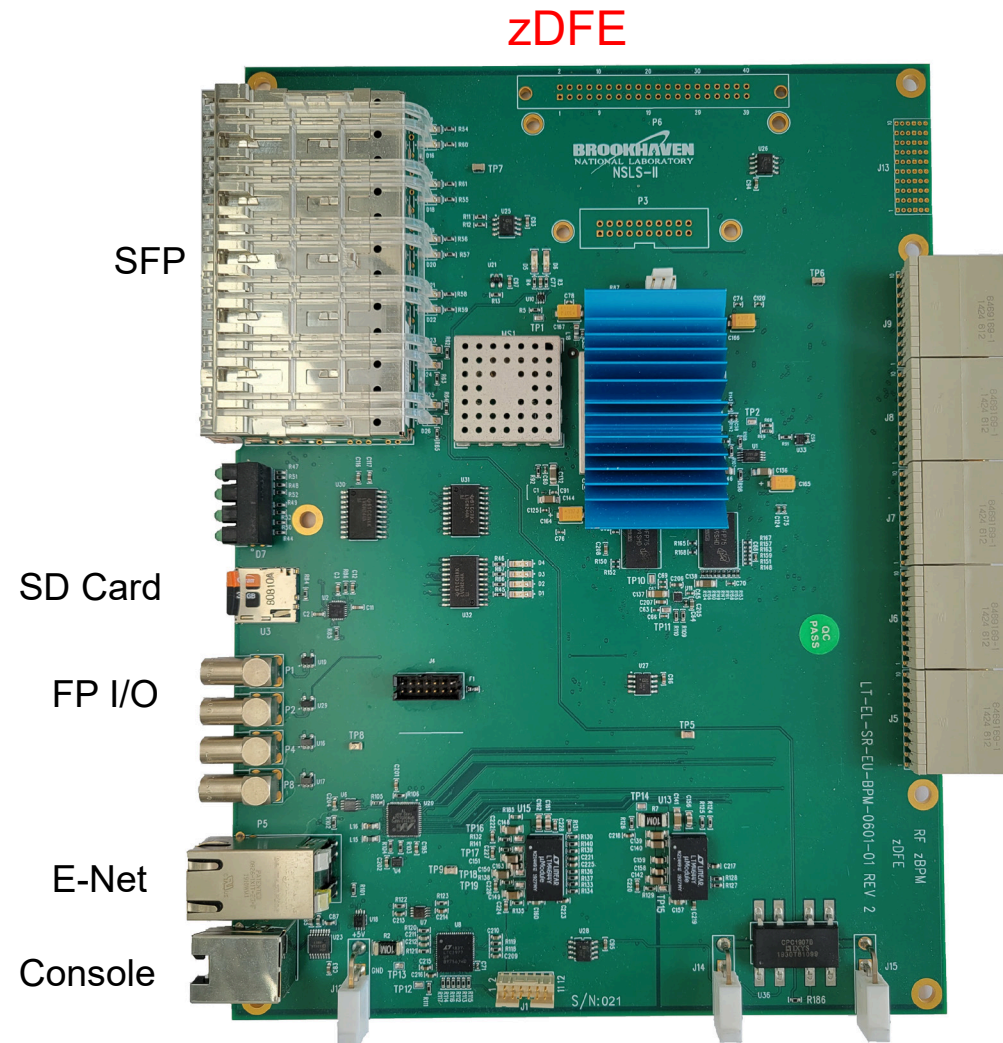

RFBPM Development Project

RFBPM Gen-3 Digital Front End (zuDFE)

- 2022 – 23 Fully Developed Prototype Gen3 Zynq Ultrascale Digital Front End board (zuDFE) for NSLS-II BPM electronics
- Required for the Gen3 (TI) ADC AFE
- Target Application:
 - RF BPM
 - Next Gen Cell Controller
- Zynq UltraScale+ FPGA XCZU9FFVB1156
 - 4GB SDRAM (PS) / 1GB SDRAM (PL)
 - 24 – 10+ Gbps transceivers
 - 6 SFP
 - 16 via rear connectors
 - 32 Gbyte SDCARD for booting
 - Gigabit Ethernet / USB 2.0
 - RJ-45 Serial Port
 - M.2 SATA SSD
 - Si5347 PLL for clocking
 - 4 front panel I/O
 - 8 front panel status LED's
 - 40 LVDS differential pairs I/O
 - 40 single-ended 3.3v I/O
 - Runs Ubuntu 20.04 Linux

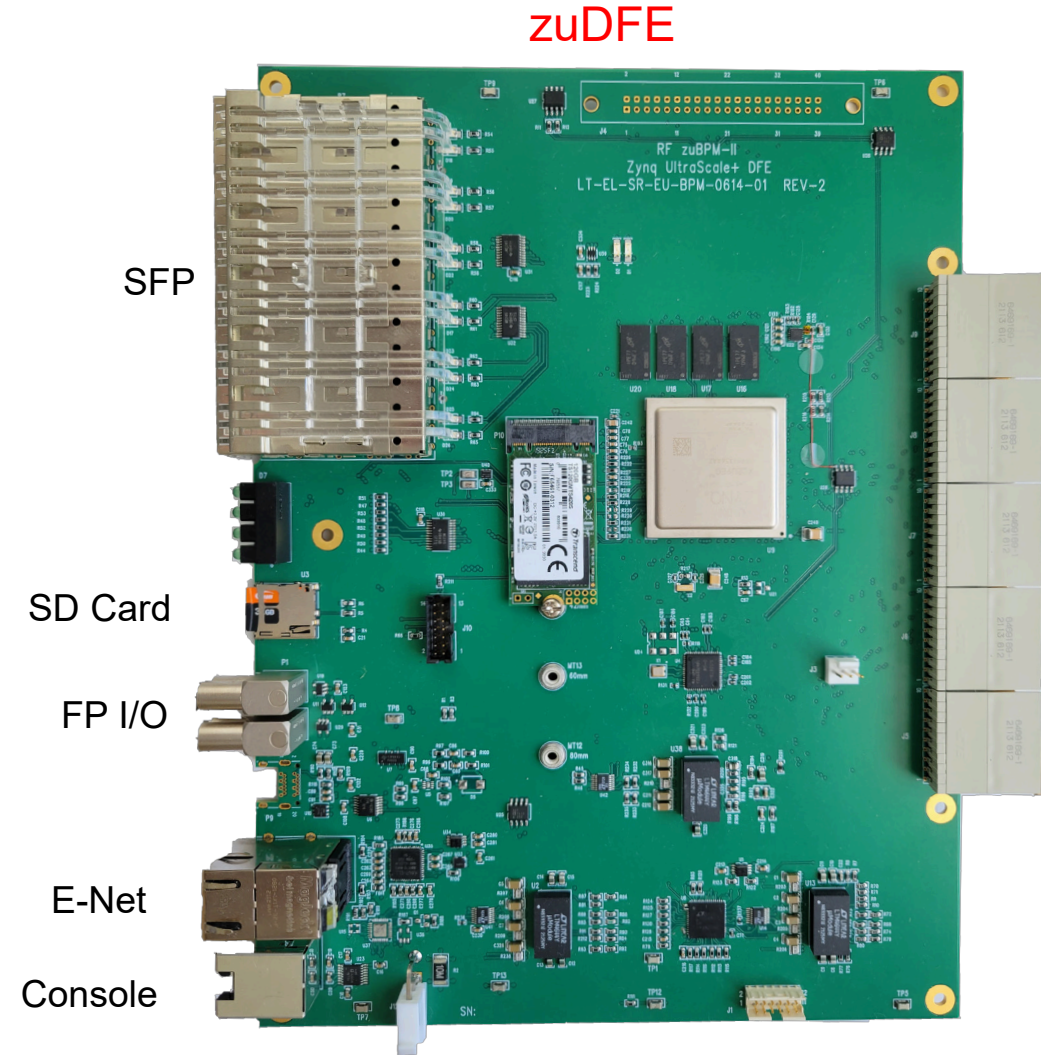

RFBPM Development Project

Gen 2 Dual ADC AFE (AD) BPM

- Fully Developed Prototype AFE Board Analog Devices Dual ADC
- Uses 2 – Dual channel, low power, **125MSPS/16Bit LTC2195 Analog Devices (AD) ADC's**
- **External analog switch (Macom MASW-007587 switch at input (20Khz) for the analog inputs)**
- **Heat pump controller board installed** (not shown) and working.
- Shown connected to zDFE board.

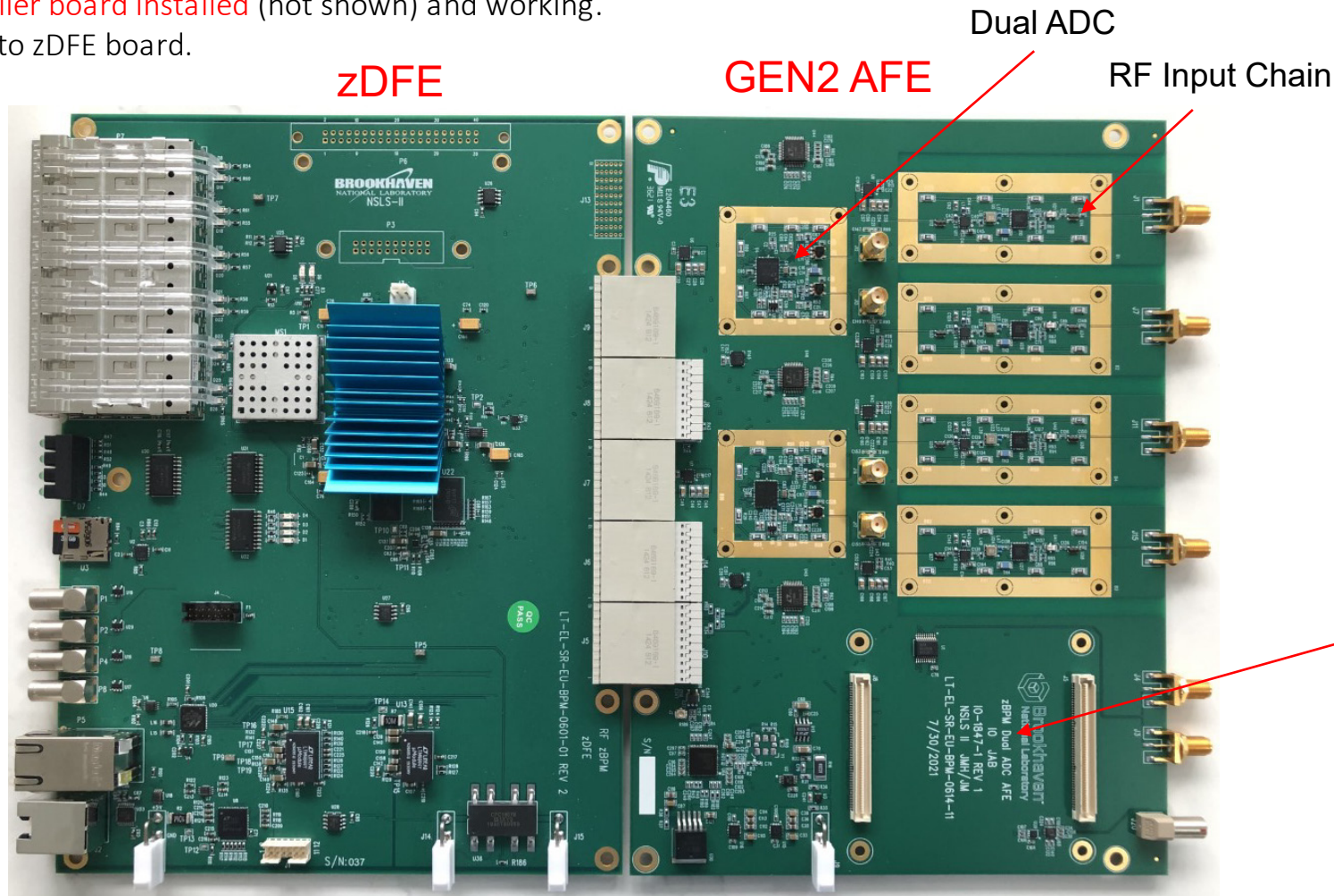

External Analog Switch (20Khz)

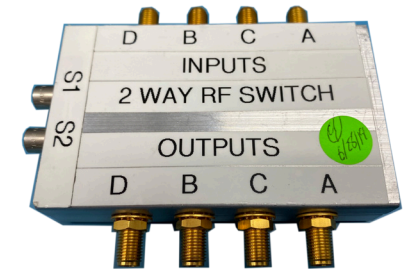

Heat Pump Controller Daughterboard

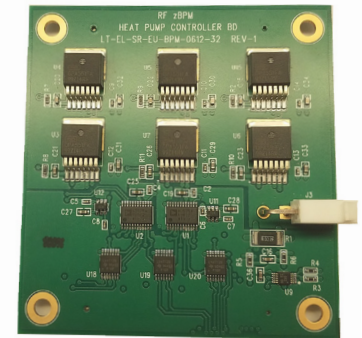

RFBPM Development Project

Gen 2 Dual AFE Temperature Stabilization

- One of the main features of this AFE board was the lower power consumption and 2 dual low power ADC's which can support better long-term stability via temperature stabilization via resistive heating.
- Can run in a rack without temperature control, and can stabilize temperatures of rf chains and ADC's to better than 0.01 degree C.
- Each RF Chain and ADC is equipped with thermistor (NTHS1206N02N1002HE) and Linear Technology LTC2986, multi-sensor high accuracy digital temperature measurement system, which provides up to 0.001 degree C resolution readback.
- Daughterboard connector is provided to support heat pump controller board.

Heat Pump Controller daughterboard

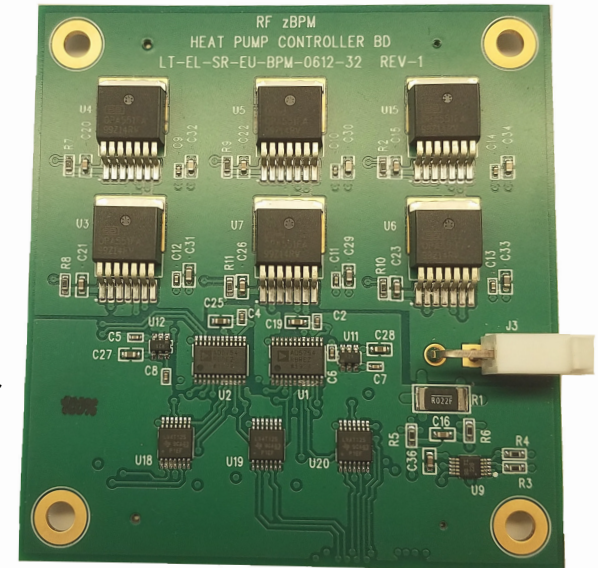

RFBPM Development Project

Temperature Stabilization Initial Results

- Developed temperature feedback control PID code using the heat pump controller board, initial results look very promising.
- Shown below, 1 channel has feedback control running (blue). Other 3 channels has feedback control off.

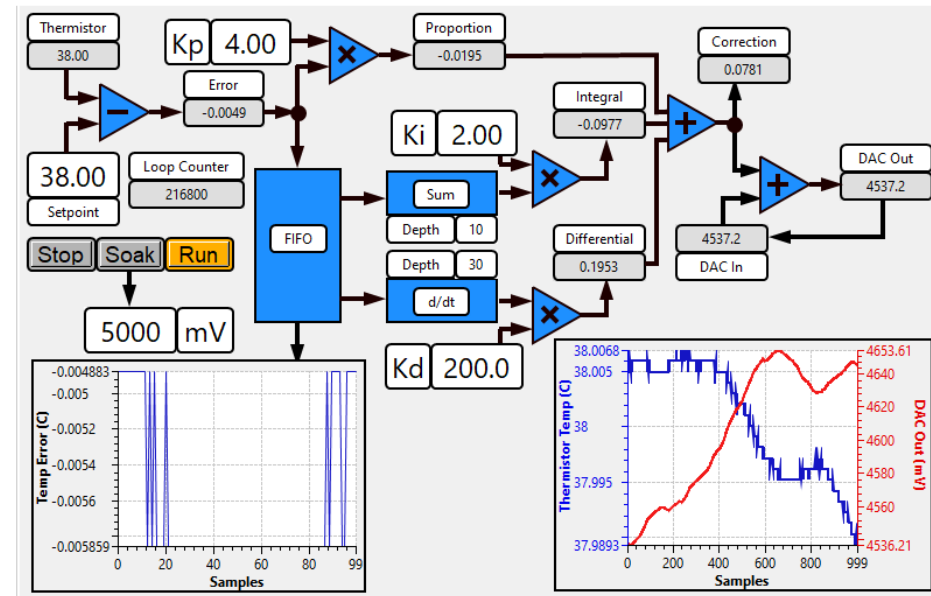
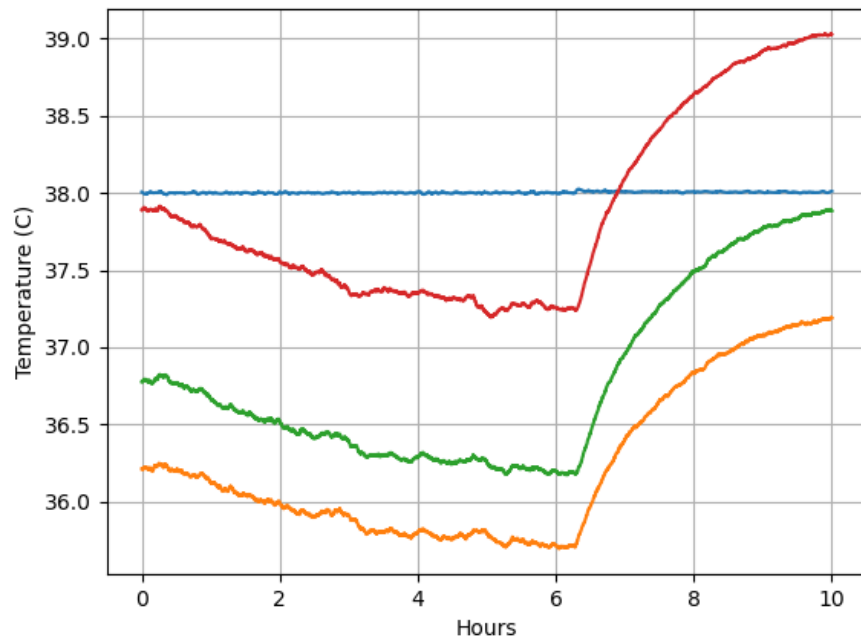

RFBPM Development

zBPM Dual ADC (AD) Initial Testing

- Gen2 AFEDual channel 125Msps / 16 Bit LTC2195 Analog Devices ADC's
- Setup is at cell 28 BPM development rack. Button signal is connected to combiner/splitter
- Results below show with and without temperature PID control(Heat Pump) and RF switching.
 - Analog Switching is external.

Test Conditions:

Condition 1	Dual ADC AFE with RF Switching OFF and PID controls OFF
Condition 2	Dual ADC AFE with RF Switching OFF and PID controls ON
Condition 3	Dual ADC AFE with RF Switching ON and PID controls OFF
Condition 4	Dual ADC AFE with RF Switching ON and PID controls ON

Summary Table:

Condition	RFSW	PID	Dual AFE x	Old AFE x	Dual AFE y	Old AFE y
1	OFF	OFF	543nm	1646nm	780nm	945nm
2	OFF	ON	130nm	1646nm	210nm	886nm
3	ON	OFF	10nm	1640nm	19nm	873nm
4	ON	ON	8nm	1643nm	9nm	882nm

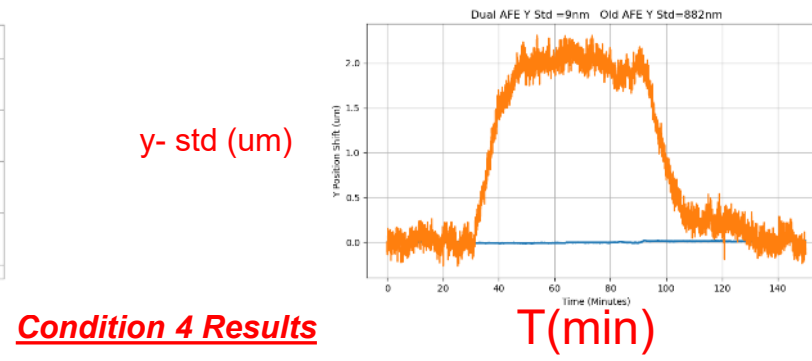
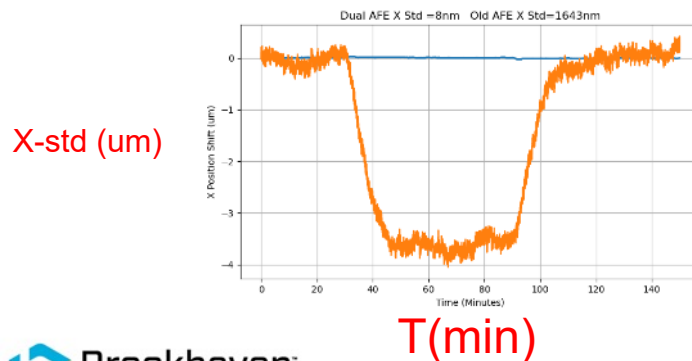
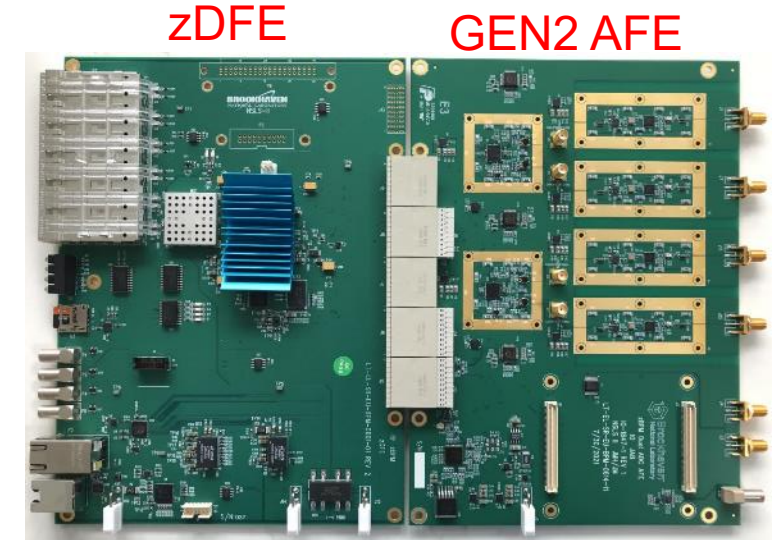

Condition 4 Results

Temperature PID On switching On

External Analog Switch

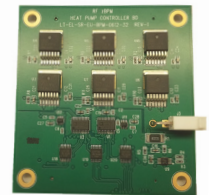
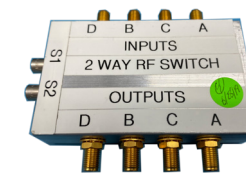

Heat Pump Controller Daughterboard

RFBPM Development

Gen2 Dual ADC (AD) AFE BPM w/integrated switches

- Based on promising results with the G2 Dual ADC board, spin new version with switches on board.
- Uses 2 – *Dual channel 125MSPS / 16 Bit LTC2195 Analog Devices ADC's*
- Added Macom MASW-007587 switch at input (20Khz) for the analog inputs
- Initial results with signal generator look good.
- Beam testing in progress.

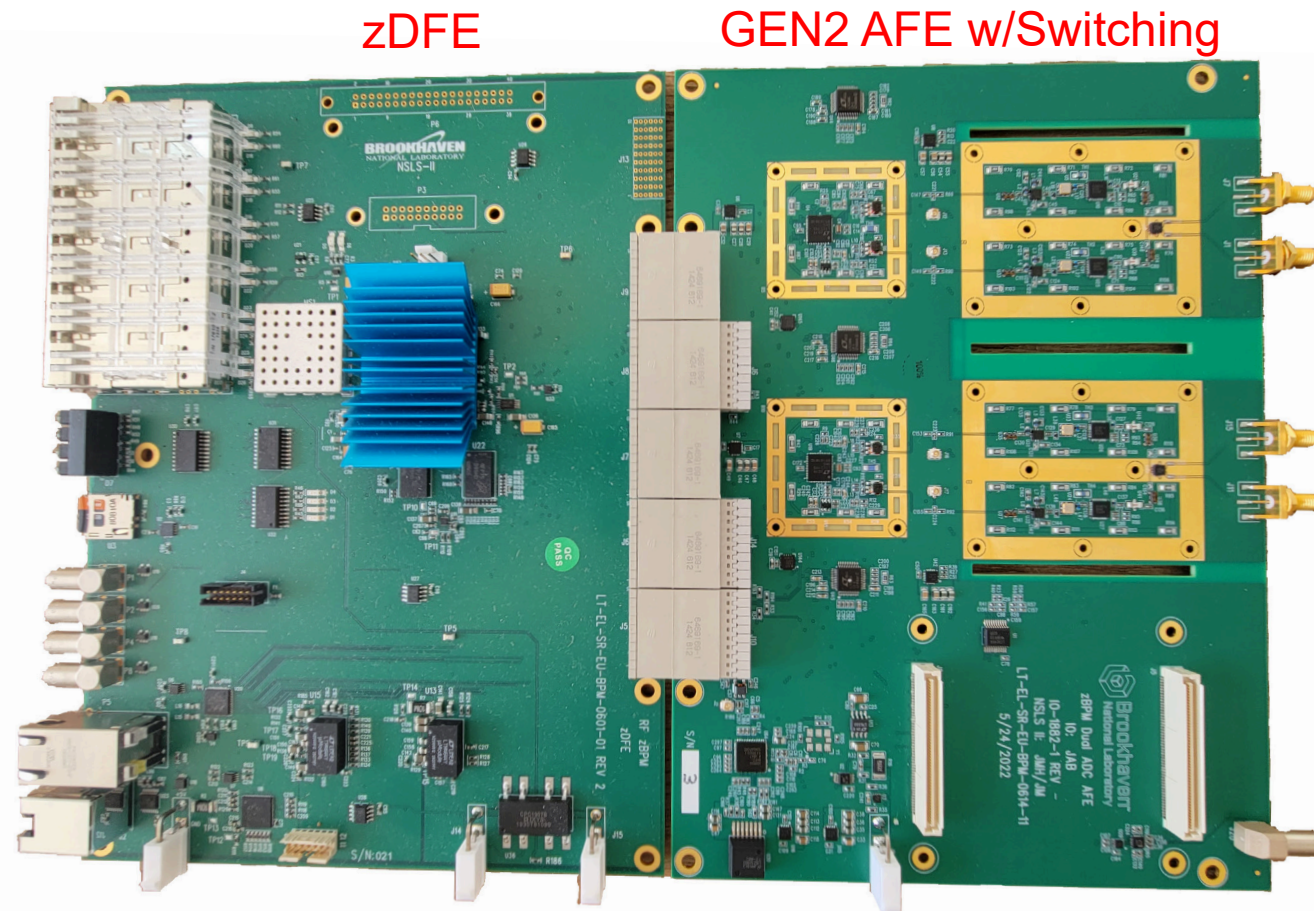

RFBPM Development

Gen2 Dual ADC (AD) AFE w/integrated switches

- Dedicated Setup at cell 28 BPM development rack. Button signal is connected to combiner/splitter
- Results below show with and without temperature PID control and RF switching.

- Analog Switching is on-board.

- Overnight Run 3-26-23 10pm–10am, ~14hrs
- Switching on, temperature PID was off
- No plastic covers over rf shields.
- Rf atten = 2dB, Max ADC counts ~ 28k.

Xstd = 18nm, Ystd = 20nm

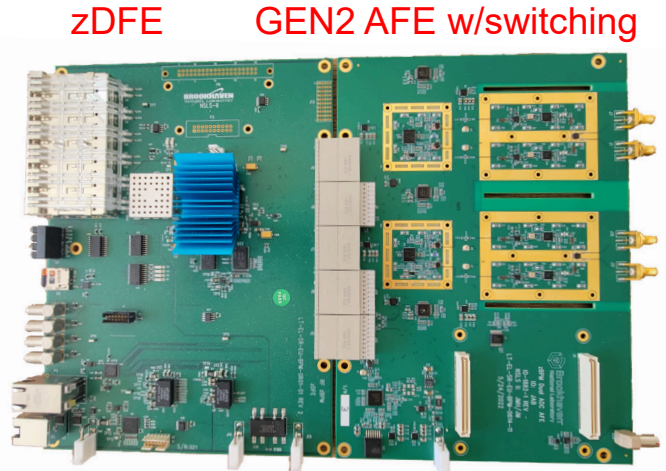
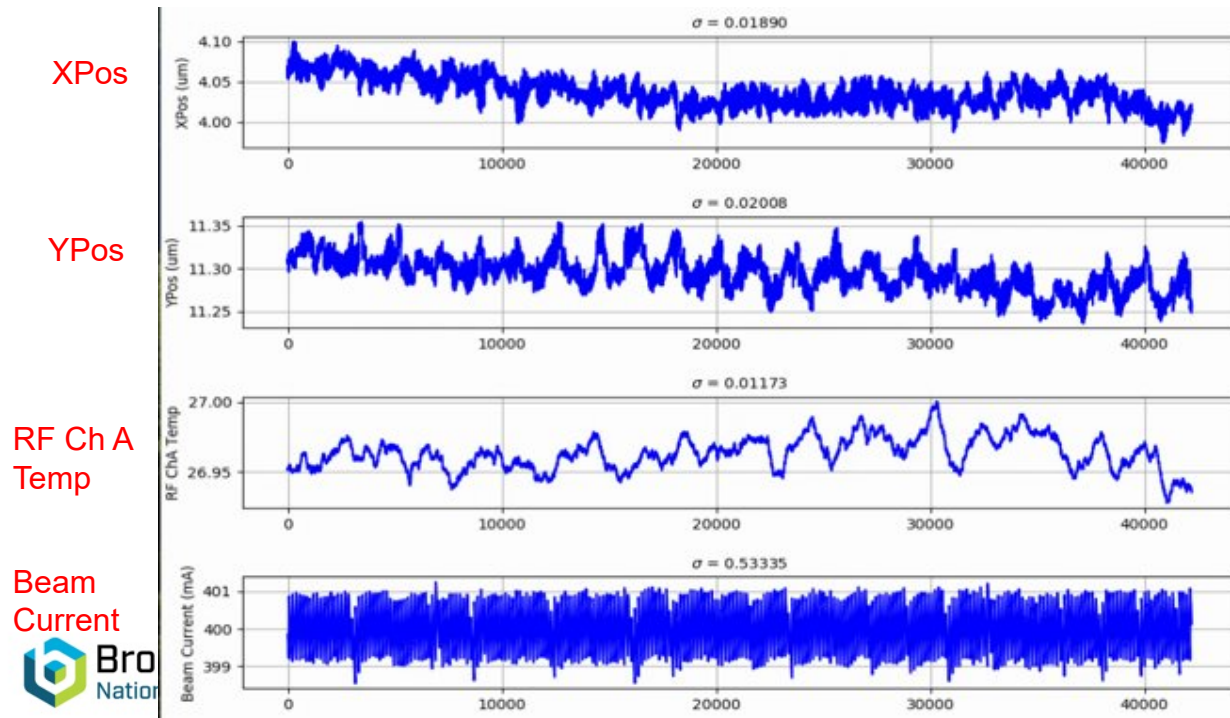

Controls Interface

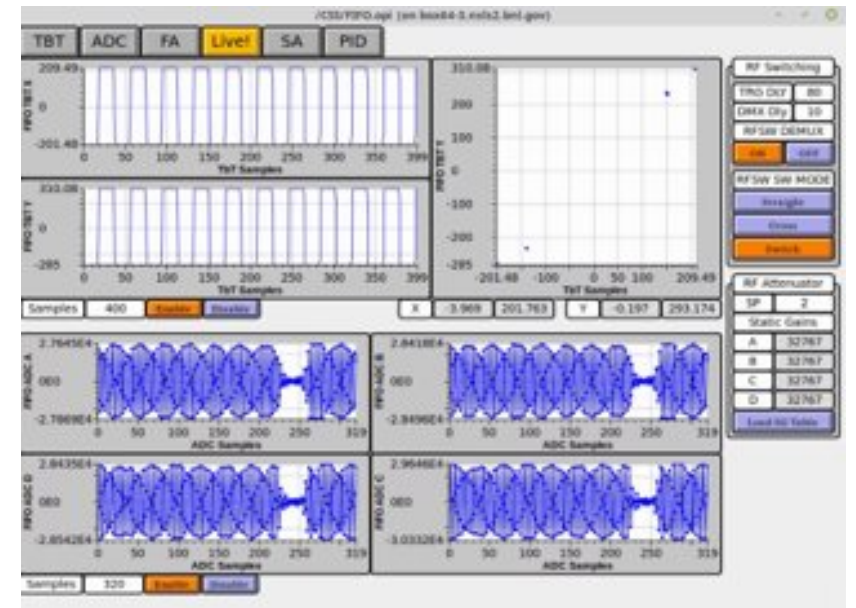

RFBPM Development

Complete Gen-2 BPM Electronics Assembly

- BPM electronics mounts into 1U chassis.
- Digital board : zDFE
- Analog board : Dual ADC (AD) (125Msps /16 Bit LTC2195 Analog Devices) ADC's
- AFE with integrated switches and heat pump controller daughterboard

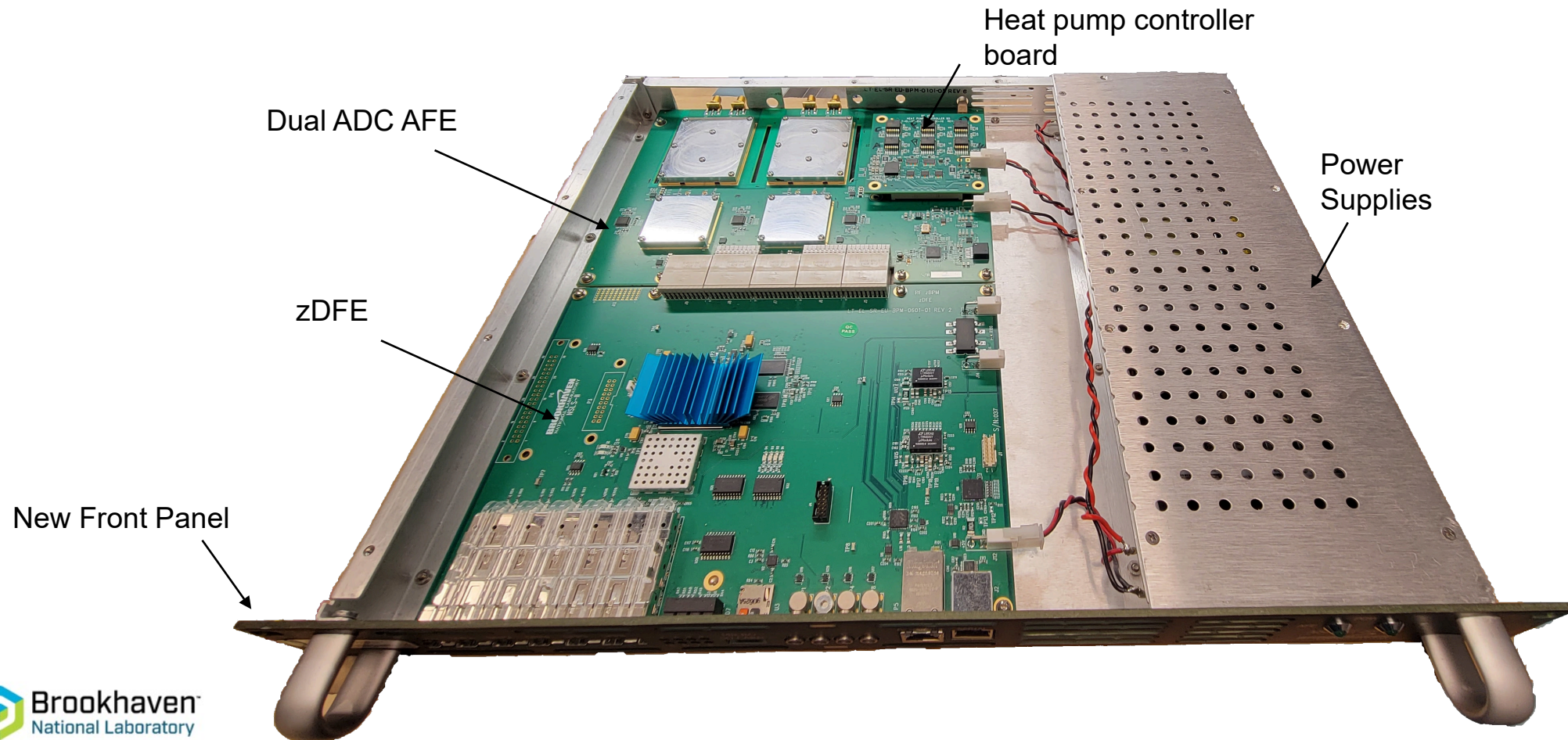

RFBPM Development

Gen3 Dual ADC AFE (TI) BPM

- Fully Developed Gen 3 Prototype AFE (Texas Instrument Dual ADC)
- Uses 2 – Dual channel 500Mps / 16Bit ADS54J69 TI ADC's
 - Option to go to 1Gps using pin compatible ADS54J60
- Sample Rate currently set to 250Mps. (ADC has a built in half band filter and decimate by 2.)
- Requires zuDFE board, needs 8 high speed transceivers for JESD204B interface to ADC's.
- Analog Switching is done externally.
- Initial testing w/promising results. Spin2 board assembly in progress.
- Ready for beam test in Nov

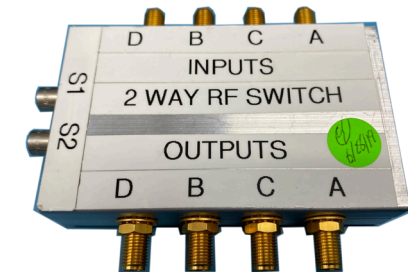
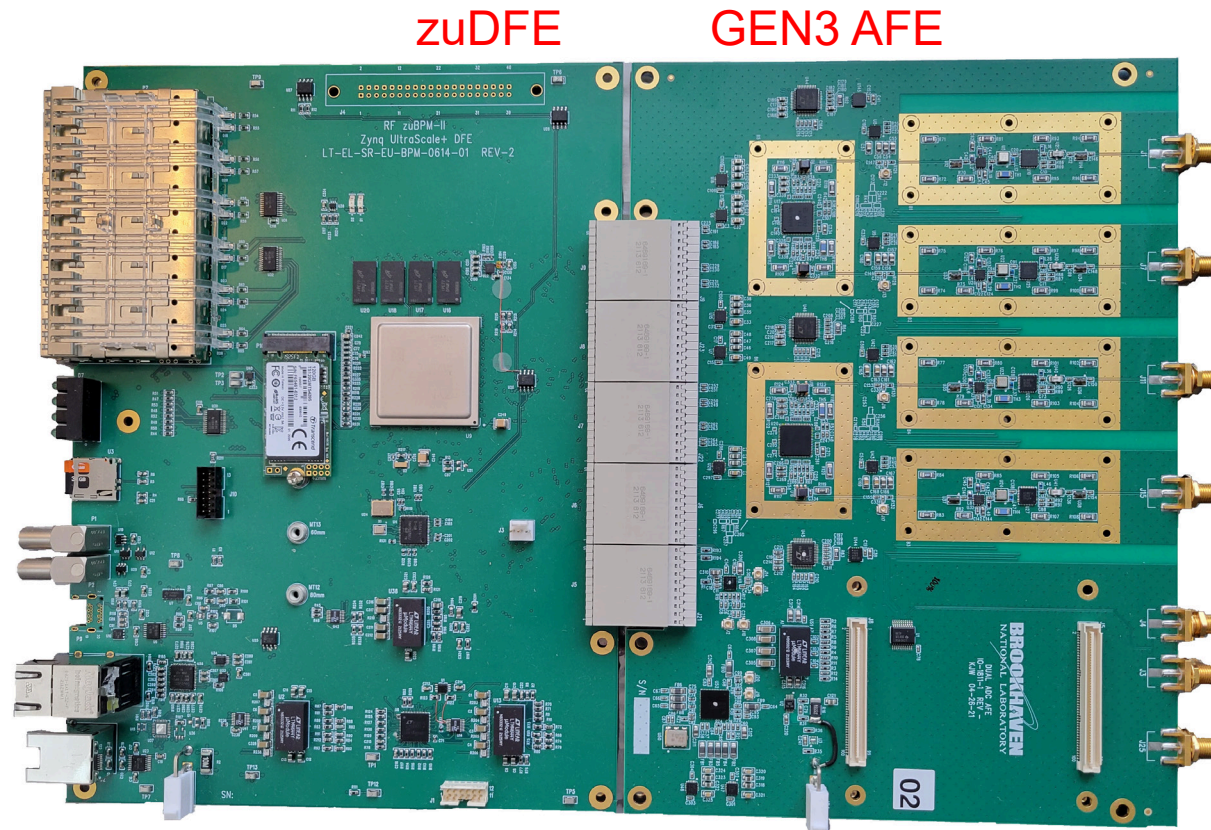

Analog Switch

RFBPM Development

Xilinx RF SOC Evaluation Board: ZCU208

- Alternate consideration for FPGA platform
- Zynq UltraScale+ RFSoc XCZU48DR-2F5VG1517E silicon featured on the ZCU208 Evaluation board
- ARM cortex-A53 processor
- Integrated 8x 14-bit 5GSPS ADCs
- Integrated 8x 14-bit 10GSPS DACs
- **Possible Applications**
 - BxB position measurements including:
 - 5 Gps ADC sampling each bunch (2ns bunch space)
 - Existing RF BPM is 117 MHz sub-sample
 - Extracting peak bunch from X10 sample data
 - Gate function, extract any bunch from 1320 fill
 - FPGA processing clock is 499.680 MHz (Sync with RF frequency)
 - FCT / WCM
 - Fill Pattern Monitor
 - LLRF.

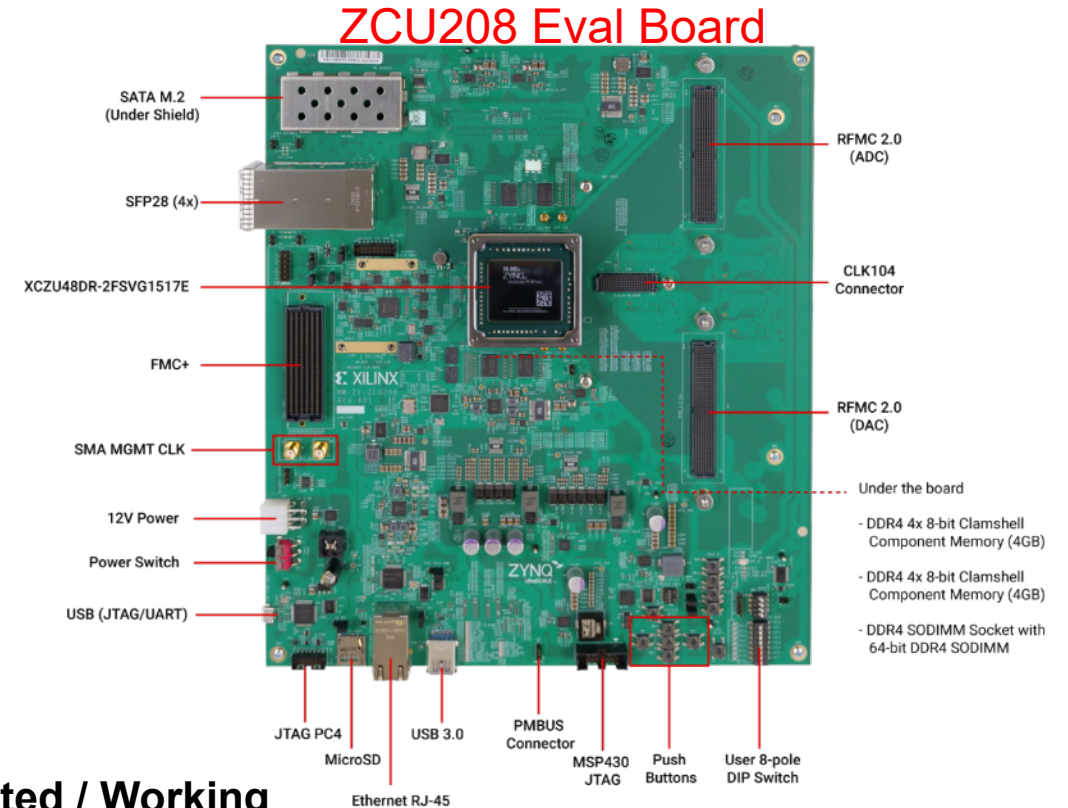

- **Completed / Working**

- Linux running.
- Initial Results from ADC at 2.5Gps and 5Gps.
- LMK04828 PLL programmed
- SI570 programmable oscillator programmed
- Embedded Event Receiver implemented
- ADC Sample clock locked to RF (via recovered clock on EVR)
- System configured in Cell 14

RFBPM Development

Xilinx RF SOC Eval Bd Test: ZCU208

- RFSOC sampled data (5 GSPS)
 - Output from Hybrid box with 560 MHz LPF
 - 10 Samples per RF bucket (200ps / sample)

3 RF Buckets
10 Samples/Bucket

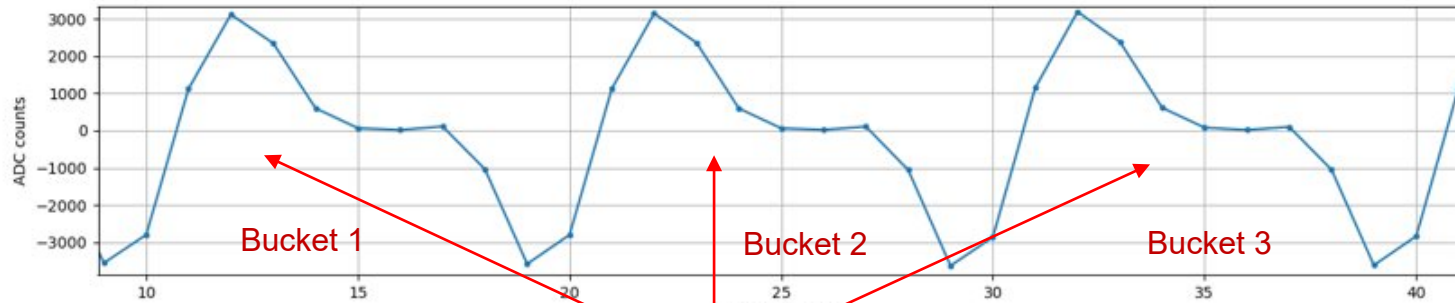

Standard Fill Pattern

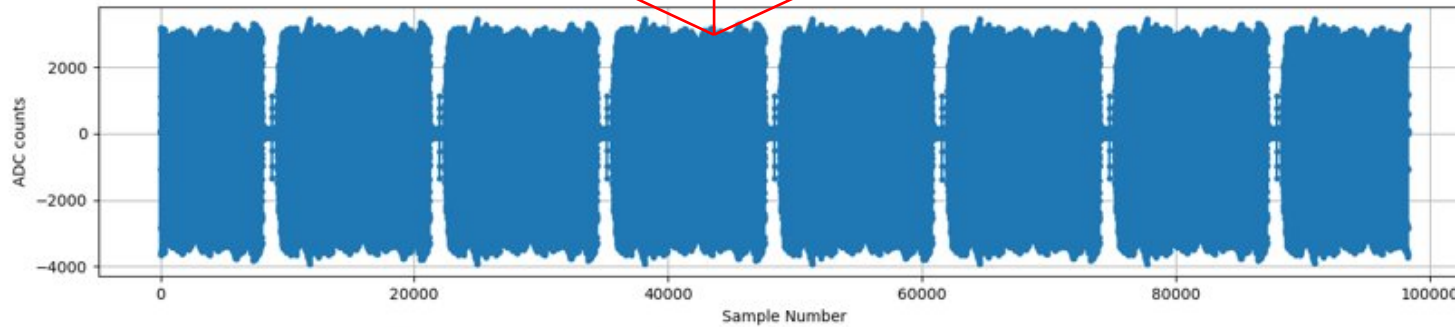

FFT

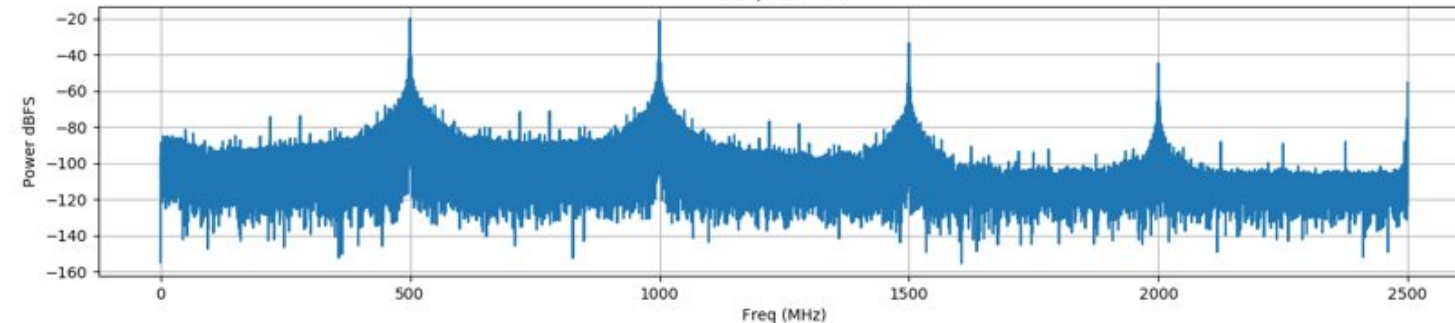

RFBPM Development

Xilinx RF SOC(ZCU208) For RFBPM application

- Preliminary TBT Test Results (no beam)
 - Sampling rate = $310 \cdot 40 \cdot \text{Frf} / 1320 \sim 4.69\text{GSPS}$
 - Using built-in DDC with a decimation factor of 40
 - Signal generator as the source, CW 499.68MHz
 - 5x improvement to V6 BPM
 - $<200\text{nm}$ (V6 BPM = $1\mu\text{m}$)

TbT Position

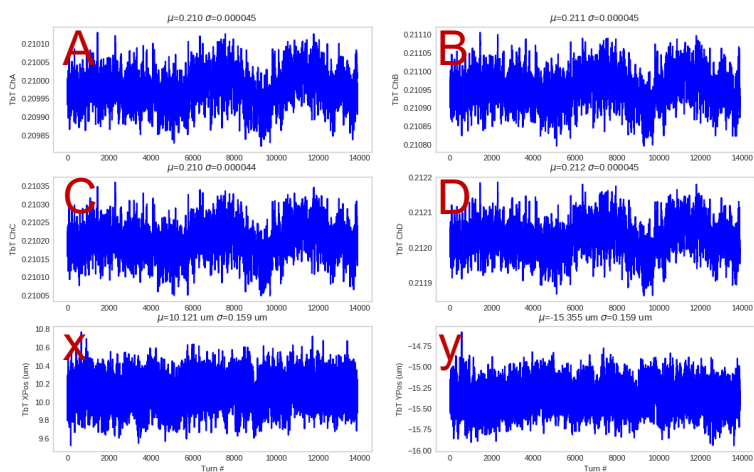

TbT Position (378kHz)
14000 Turns
 $<200\text{nm}$

FA Position

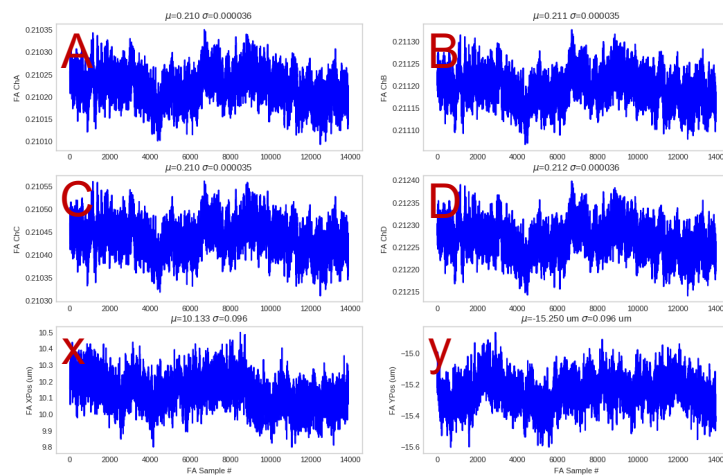

FA Position (10kHz)
14000 Samples
 $<100\text{nm}$

SA Position

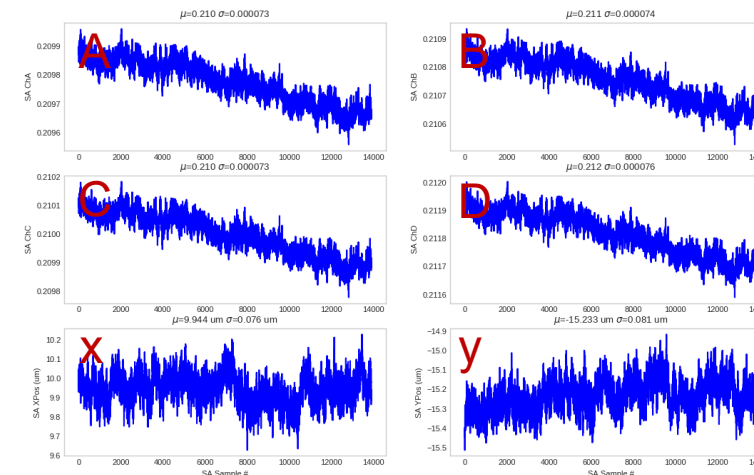

SA Position (10Hz)
 $<80\text{nm}$

RFBPM Development

Custom RFSOC DFE Board Design

- **Prototype RFSOC Zynq Ultrascale+ Digital Front End board design (rfsocDFE) for NSLS-II BPM electronics**

- High Sample Rate BPM, up to 5GSPS
- Compatible with existing chassis

- **Target Application:**

- SR/Injector RF BPMs (2 BPMs in one!)
- Common Platform DFE
- Cell Controller
- BxB RF BPM

RF AFE Daughter Board

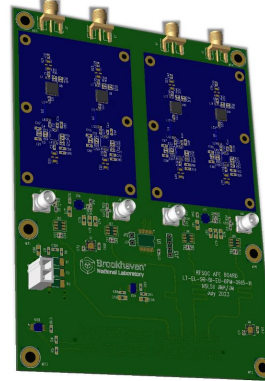

- **Prototype RF AFE Analog Front End board (rfAFE) for rfSOC DFE**

- Similar RF chain to that of the Dual AFE boards
- Interfaces directly to either ZCU208 or rfsocDFE Board
- Higher gain Amplifier MML09212HT1
- Replaced SAW BPF with more stable Ceramic BPF
- Layout Complete, PCB Assembly for test expected in Sept.

NSLS-II RFSOC Board

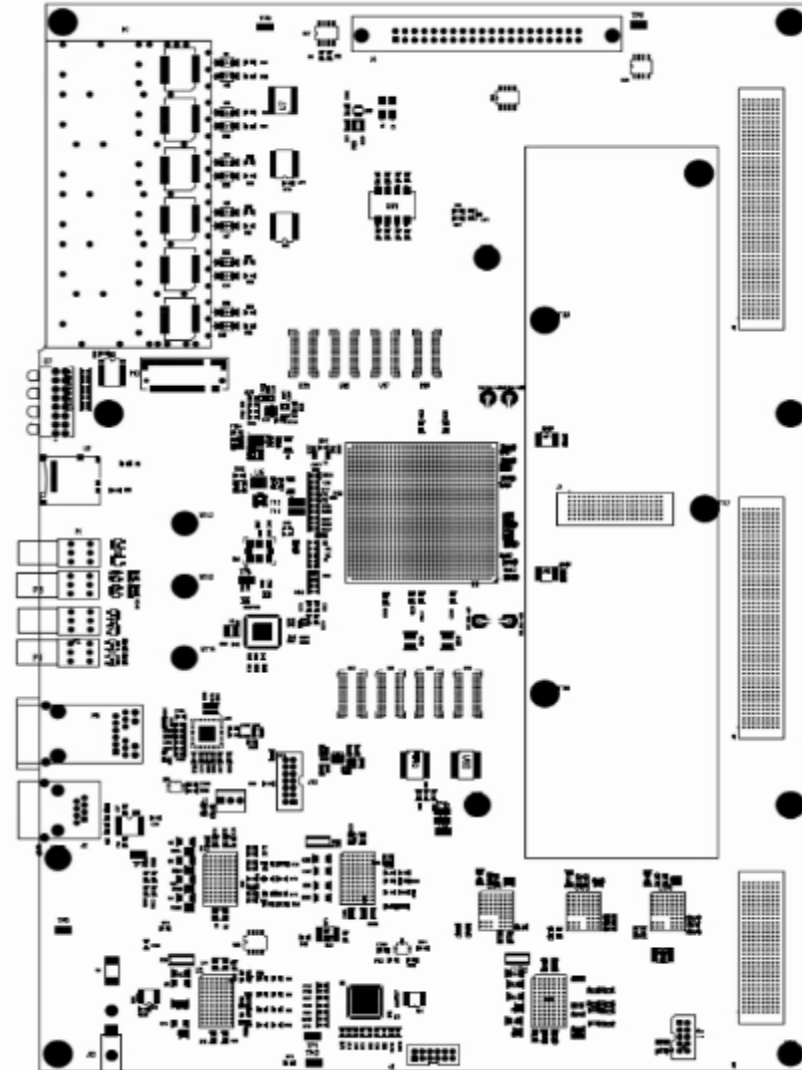

Today's Xray BPM Electronics

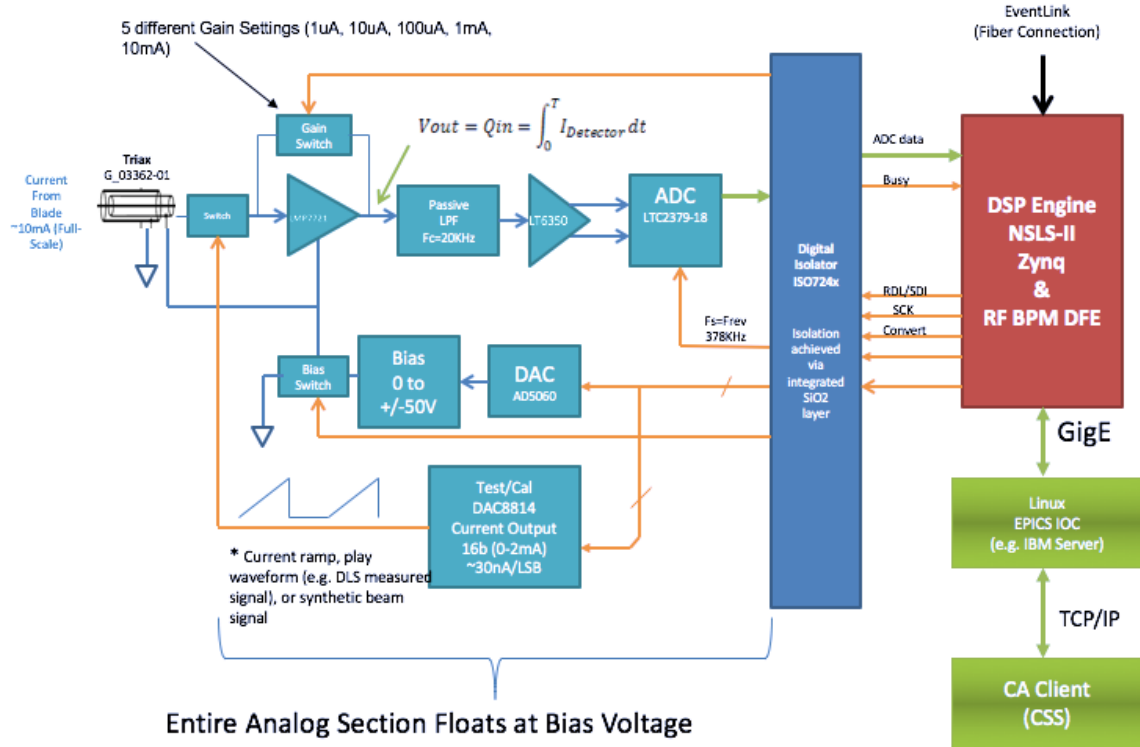
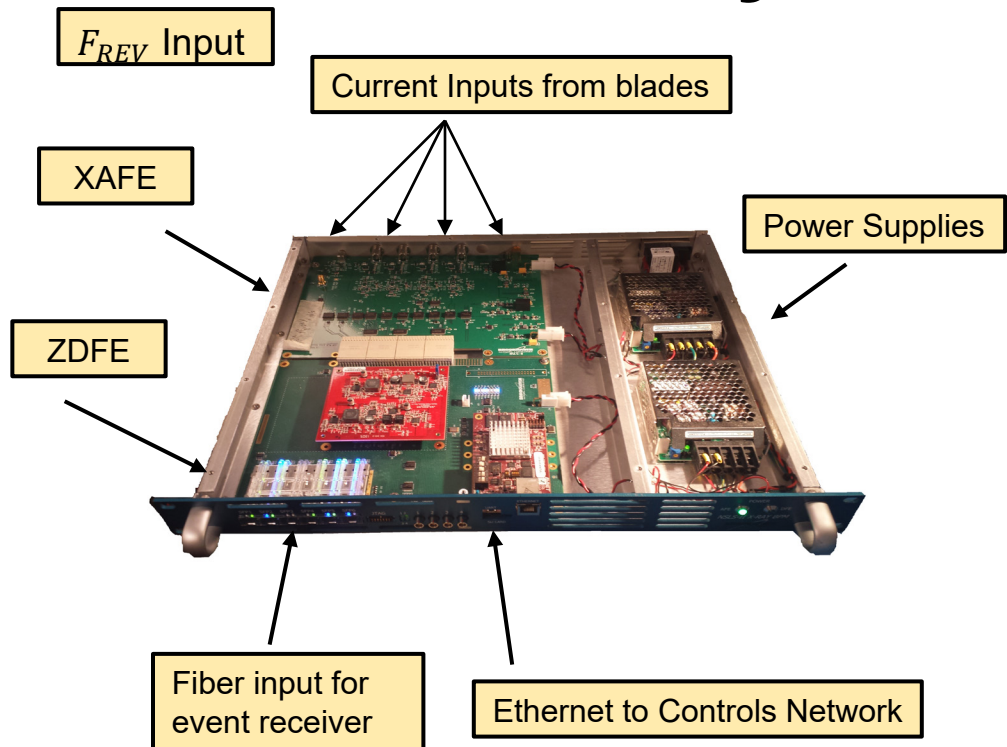

Presently Installed at 3 Beamlines

Features:

- Linux Operating System
- Embedded EPICS IOC and caClient Applications
- Python scripts for FFT calculations and other data processing
- Knowledgeable Users have access to all internal functions
- Very flexible, changes can usually be implemented within hours

Tomorrow's Xray BPM Electronics

Advantages:

- In-House Development
- Small compact module
- Designed to interface to front end equipment such as diamond bpm's, ion-chambers, etc.
- Interchangeable Voltage/Current Monitor
- Capable of providing feedback on X-ray beam position and provides fast feedback control on various beamline components
- Multiple programmable rate data streams are available to the user with nominal data rates of 10Hz, 10KHz and full ADC line rate.
- Embedded Event Receiver allows the module to run synchronized to the accelerator complex and receive global and local accelerator commands which permit easy synchronizing of data and time-stamping with other beamline components

Electrometer



Performance Parameters

Readout Channels	4 Current (independent gain control) 4 Voltage (independent gain control)
Current Measuring Range	6 programmable current ranges: 100nA, 1uA, 10uA, 100uA, 1mA, 10mA
Data Rate	Programmable, up to NSLSII turn-by-turn rate , 378.545KHz
Resolution Bits/Sample Rate	20 / 400Ksps
Bias Voltage Output	-10v to +10v
Current Polarity	Bipolar

I/O Interface

Control Interface	RJ45 – 10/100/1000 Ethernet Embedded EPICS IOC/LINUX OS
High Speed Interface	SFP – Gigabit Ethernet
Embedded Event Receiver	SFP
Electrometer Inputs	SMA
Bias Output	LEMO
Feedback Outputs	LEMO
Power	+5v @ 1A

RFBPM Development Summary / Look Ahead

- zDFE FPGA board in use since 2018.
- ZuDFE board prototype in testing, most features working. Spin 2 ready for Nov
- Gen 2 AFE board (dual, 117Msps / 16bit (AD) ADC)
 - Initial results are looking very good. More test results in the next few months
 - Version of the board with integrated switches complete, testing in progress.
- Gen 3 AFE board (dual, 1GSPS / 16bit (TI) ADC)
 - PLL and ADC seem to be working ok. Needs more firmware development and testing
- RFSoc Platform (zcu208 Evaluation Bd)
 - Have 1 ADC channel working at 5GSPS.
 - A version with 4 channels working.
 - Linux is running. IOC in progress
 - ADC clock is locked to the RF. Embedded event receiver is working.
 - Initial data with Beam looks promising.
- Gen 4 RFSoc (Custom Board Design)
 - Schematics Complete
 - Ordered 10ea Xilinx RFSoc FPGAs (XCZU47DR-1FFVG1517I)
 - Board Design in progress, Target Completion Nov

Acknowledgements

Contributions to this presentation:

Joe Mead, Kiman Ha, Tony Caracappa, Bel Bacha

Next Generation RFBPM Development/Test:

Joe Mead, Tony Caracappa, Kiman Ha, Bernie Kosciuk, Bel Bacha, Christian Videbaek, John Bohenek, John Hammond, Mike Capotosto, Artie Munoz, Ray Gonzales

Data Science & System Integration (DSSI):

Stuart Wilkins, Yuke Tian, Kiman Ha, Rob Reiner, Yong Hu

NSLS-II Accelerator Division

Timur Shaftan, Greg Fries, Helena Lewis

Thank You !