

Abstract: The ability of reliably measuring the transverse beam profile in its injectors is essential for the operation of the LHC. This report aims to assess the reliability, stability, and reproducibility of the new generation of beam wire scanners developed at CERN in the framework of the LHC Injectors Upgrade (LIU). The study includes data from the over 60000 scans performed in 2021 and 2022, with a special focus on reproducibility, investigation of optimal operational settings to ensure a large dynamic range, and evaluation of absolute accuracy through comparison with other instruments present in the injectors.

DESIGN AND LAYOUT

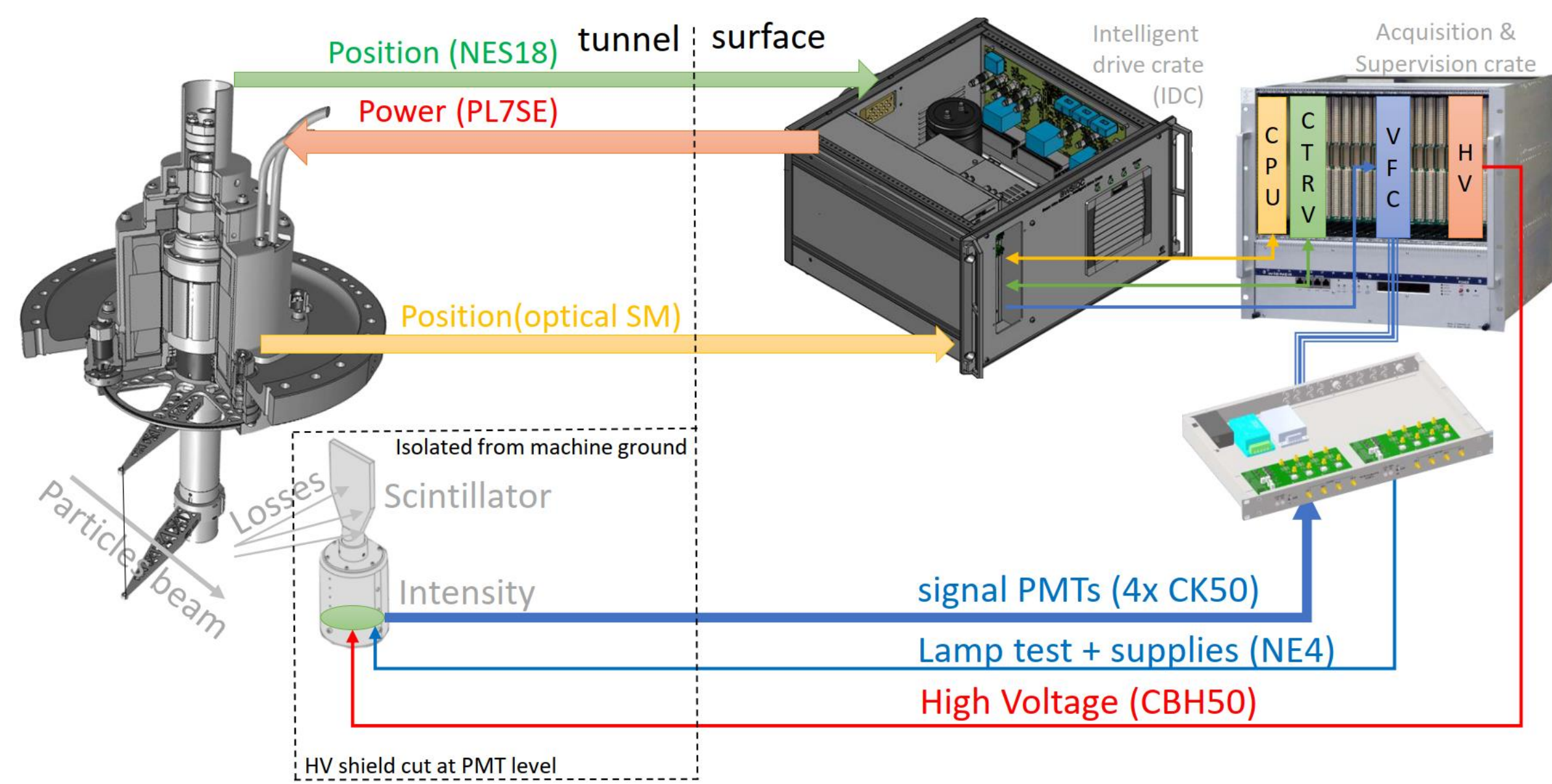

Figure 1: The kinematic unit and particle detectors (left side) are located in the accelerator tunnel. The stand-alone control unit and the VME acquisition system (right side) are in the surface service area. The communication from the tunnel to the surface is done with cables and optical fibers, with lengths above 150 m in some cases.

COMMISSIONING WITH BEAM 2021-2022

Seventeen new BWSs installed in the LHC injectors (PSB, PS, SPS) have been extensively used in 2021 and 2022 by operation crews to setup, tune, and characterize the new LIU beams, resulting in tens of thousands of scans. The only system failure reported in 2021 was a broken wire, due to an issue with carbon wire copper coating (used to ease the wire fixation) that was known since the first LS2 (2018-2020) tests.

Usage up to July 2022:

- PSB ~ 48000 scans
- PS ~ 17000 scans
- SPS ~ 16000 scans

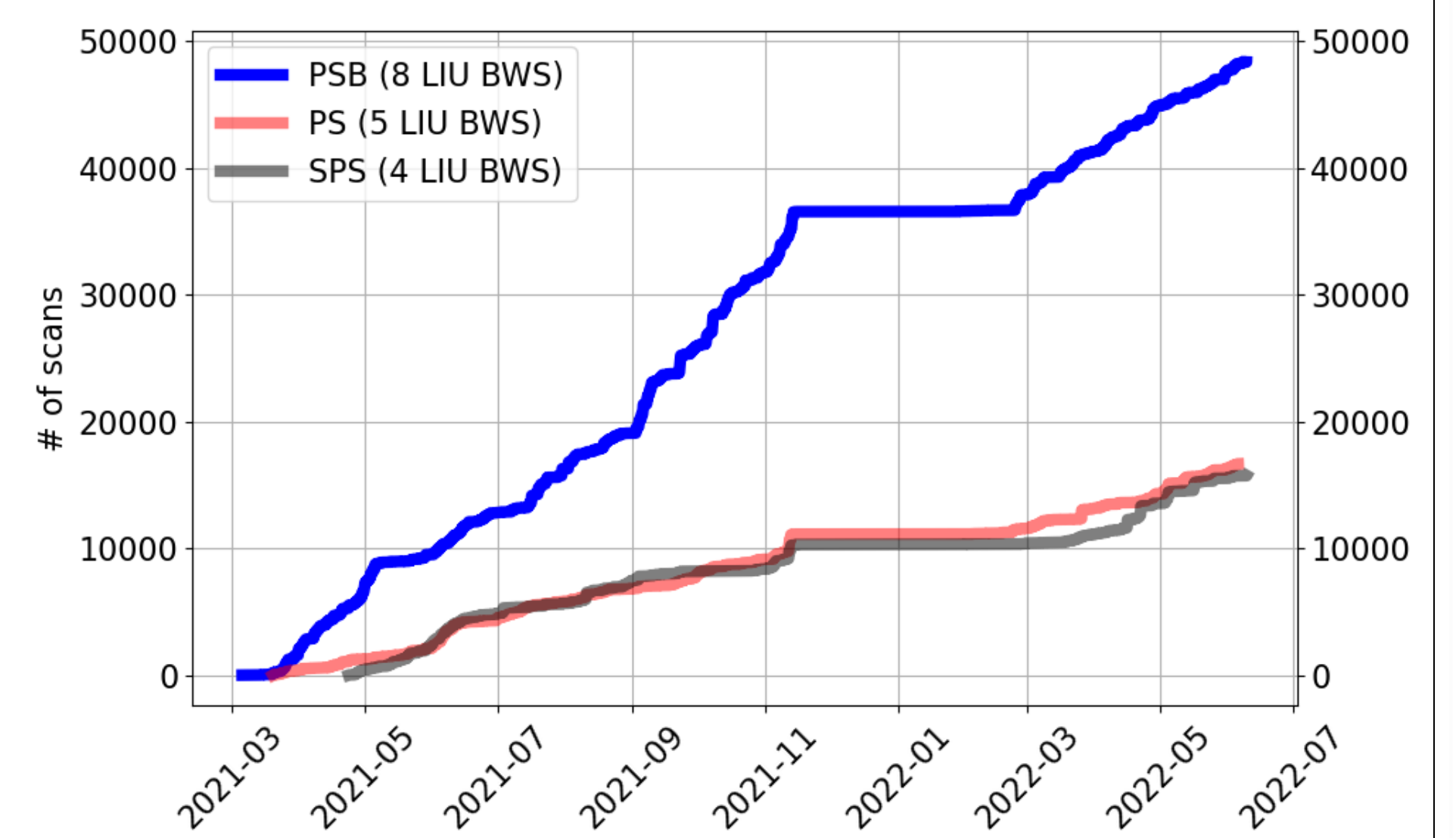

Figure 2: Usage statistics of the LIU BWS in the LHC injectors during 2021 and up to July 2022.

SINGLE-BUNCH MEASUREMENTS

Each measurement results in 4 estimations of the beam size, corresponding to the 4 PMTs with different attenuation filters. The best estimation of the beam size can be obtained by properly changing the high voltage and using the appropriate PMT channel, with PMT channels with different attenuation. The high voltage for the PMTs must be chosen so that the signal is above the noise level, but at the same time does not saturate the digitizers or cause the PMTs to go beyond their linear regime. Both these effects may lead to an overestimation of the beam size. Once the optimal high voltage has been selected, the BWS system has an algorithm to automatically select the best PMT.

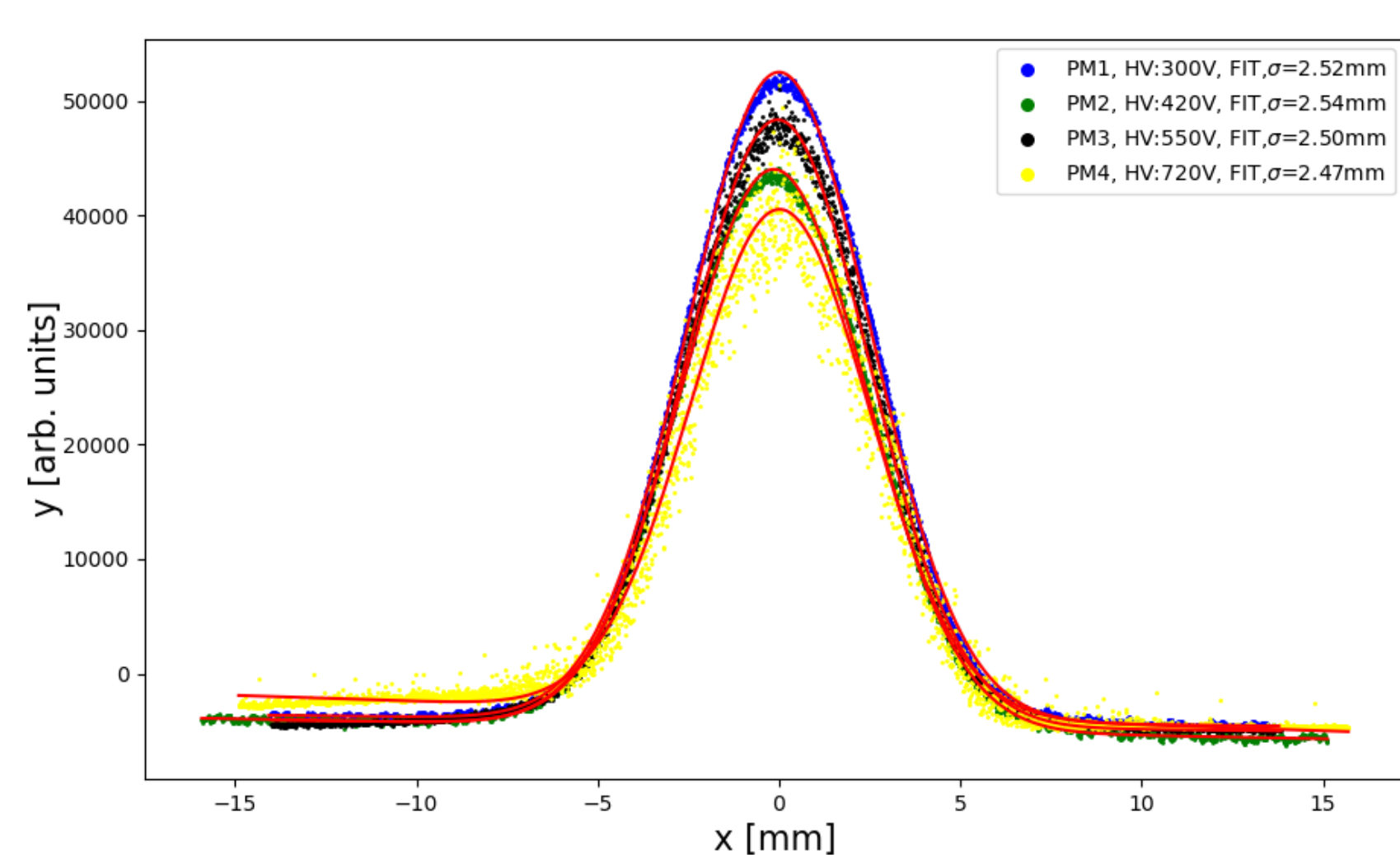

Figure 3: PSB horizontal profile of a LHC25 beam as measured by one of the LIU BWS. The 4 measurements are taken at different HV values and agree within 3% in terms of beam size.

MULTI-BUNCH MEASUREMENTS

The LIU BWS have a standardized hardware and software design that applies to the PSB, PS, and SPS, and were designed to provide high availability and reliability. The new BWS overcome the limitations of the previous BWS in the LHC injectors. The old linear scanners in the SPS had strong limitations on beam intensity due to their low speed (1m/s), potentially leading to wire sublimation. The new BWS (24m/s) can measure all the 288 LHC25 bunches in the SPS. The old rotational scanners (PSB, PS, SPS) typically featured a precision on the position of the wire that was never better than 100µm (10µm for the new ones) and was significantly influenced by electronic noise on the potentiometer reading, mechanical play, and vibrations.

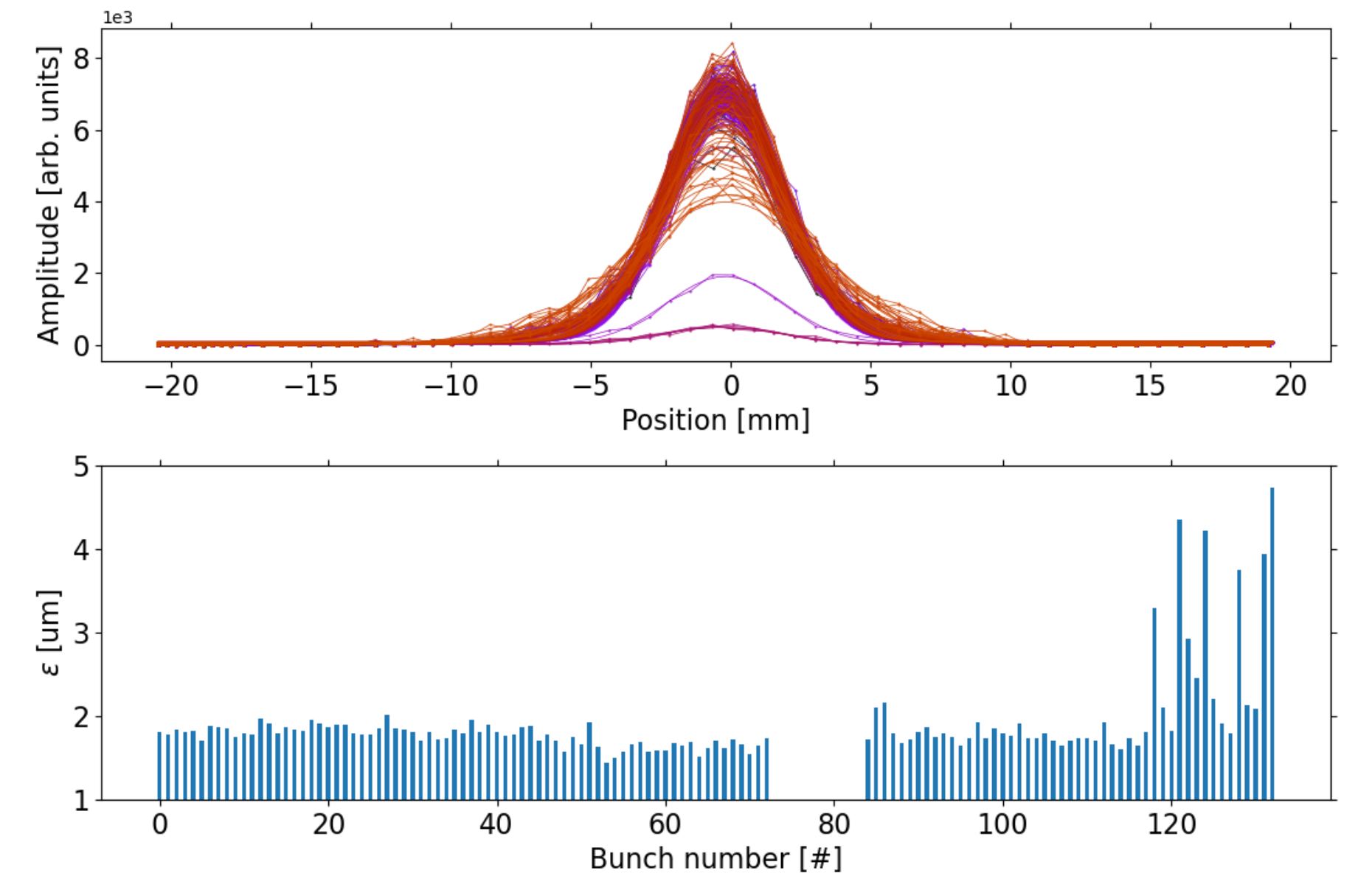

Figure 4: LIU wire scanner BWS.41677.V measurement in the SPS (top) of 25ns separated bunches (LHC Type beam). The beam emittance growth at the end of the train is due to the electron cloud effect (bottom).

WORKING POINT AND UNCERTAINTY STUDIES

Figure 5 shows one of the studies performed to evaluate the selection of the optimal high voltage working point for the acquisition of a beam profile, in this case measuring the horizontal size of a LHCINDIV beam. The high voltage is increased from 300V to 1000V in steps of 25V. Both residuals minimization and system algorithm provide an average sigma of 2.21mm, but the set of beam sizes selected by the algorithm has a lower relative STD, showing that the algorithm provides the optimal PMT for each measurement. Figure 6 shows two measures per scan (IN/OUT) in the PS that are consistent with each other. Figure 7 shows a comparison between LEGACY and LIU BWS in the PSB. We compare vertical emittances to minimize uncertainties arising from dispersion functions and momentum spread. The comparison indicates good agreement showing that the measurements provided by the LIU system are consistent. Mixing measurements from both systems and calculating the average RMS provides an upper limit estimation of the systematic uncertainty of 4%. The average statistical uncertainty is about 3% for the LEGACY system and 2% for the LIU system, and it was estimated from the RMS of the beam size distributions. Preliminary upper limit statistical uncertainty estimations on the beam size are 3% and 5% for the PS and SPS LIU BWSs, respectively.

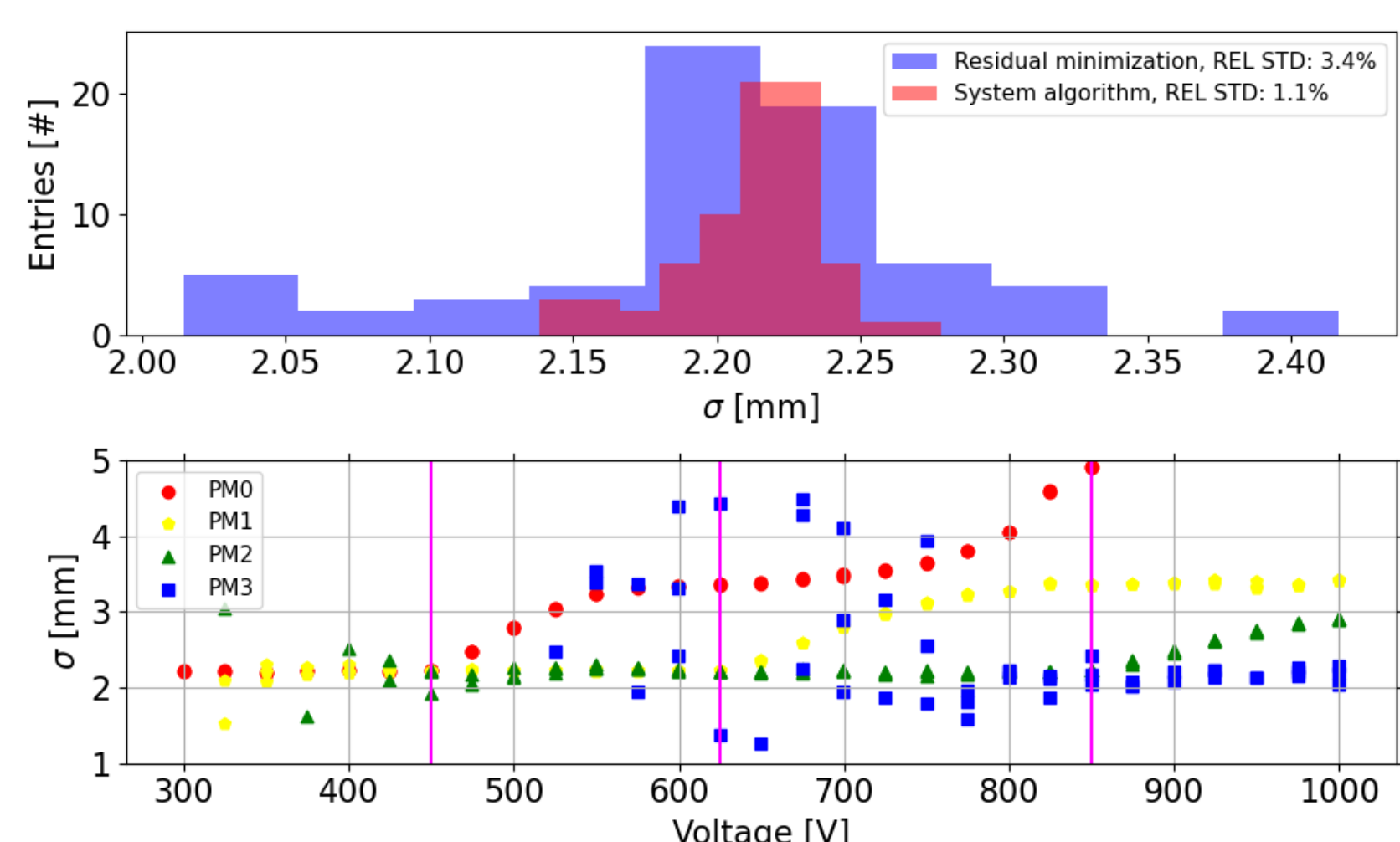

Figure 5: Top: comparison between residual minimization and algorithm methods to select optimal PMT. Bottom: voltage scan with vertical lines indicating optimal ranges for each PMT.

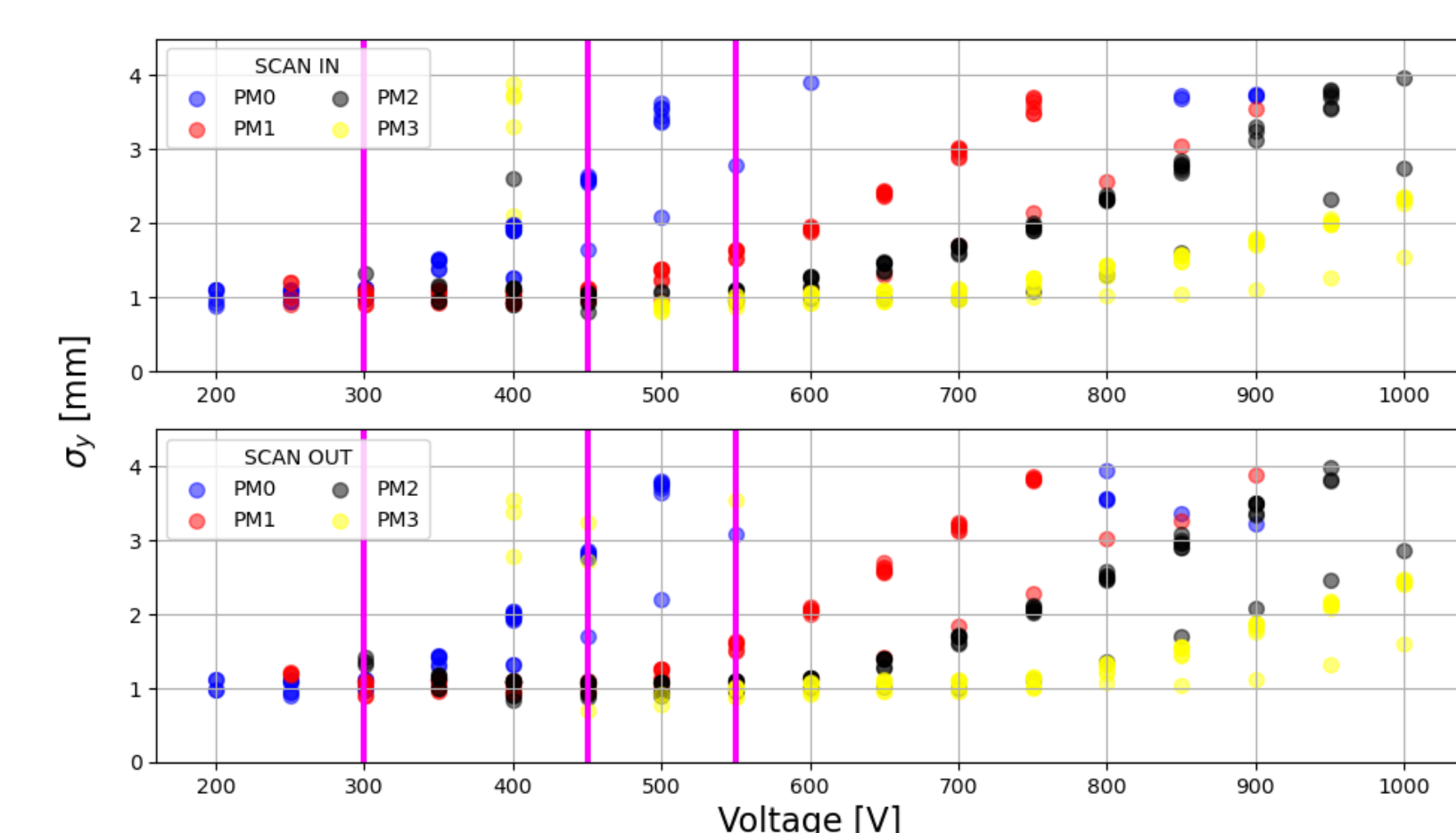

Figure 6: Voltage scan performed in the PS for a beam of type LHC25.

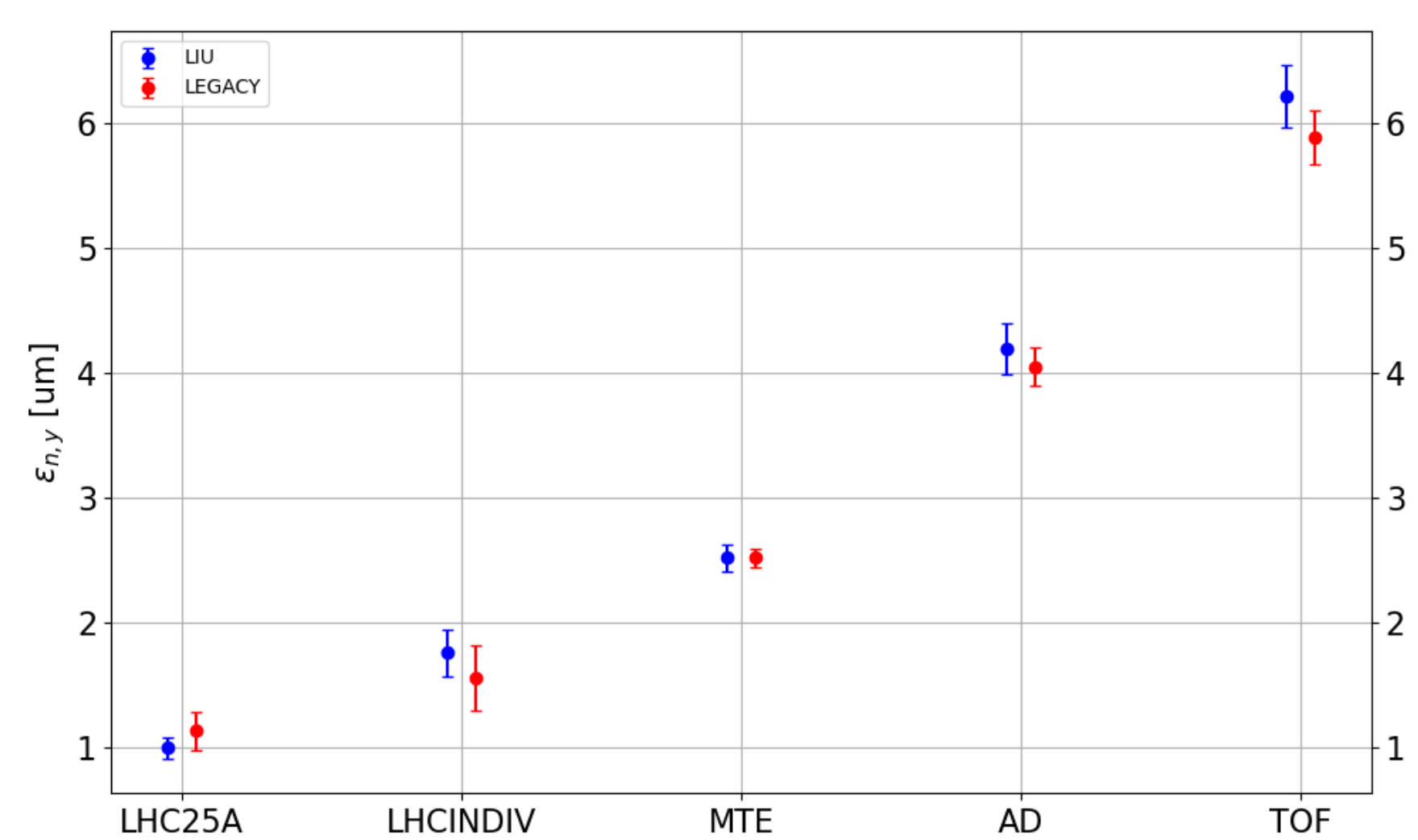

Figure 7: Comparison between LEGACY and LIU BWSs in the PSB for different beams.

$$\epsilon_n = \gamma_{rel} \beta_{rel} \epsilon = \gamma_{rel} \beta_{rel} \frac{1}{\beta} \left[\sigma^2 - \left(\frac{\Delta p}{p} D \right)^2 \right]$$

Statistical error (upper limit):
 PSB LEGACY: ~3% (emittance)
 PSB LIU: ~2% (emittance)
 PS: ~3% (beam size)
 SPS: ~5% (beam size)

Systematic error (upper limit):
 PSB: ~4%

SUMMARY & OUTLOOK

We showed that the new LIU BWS was successfully commissioned in the LHC injectors and it is able to provide reliable and precise measurements with improved availability compared to the old BWS. Two new prototypes BWS have been designed for the LHC, in the context of an electro-mechanical consolidation, to cope with previous recurring operational system failures. The LHC prototypes are linear - in contrast with the rotational BWS installed in the LHC injectors in the context of the LIU upgrade - and mechanical modifications and new electronics have been designed.

ACKNOWLEDGEMENTS

We gratefully acknowledge the help, during BWS measurement sessions, of Gian Piero Di Giovanni, James Ridewood, Hannes Bartosik, and Georges Trad.

REFERENCES

- [1] M. Meddahi et al., "LHC Injectors Upgrade Project: Towards New Territory Beam Parameters," in *Proc. 10th International Particle Accelerator Conference (IPAC'19), Melbourne, Australia, 19-24 May 2019*, International Particle Accelerator Conference, https://doi.org/10.18429/JACoW-IPAC2019-THXPLM1, Geneva, Switzerland: JACoW Publishing, Jun. 2019, pp. 3385-3390, issn: 978-3-95450-208-0, noc: doi: 10.18429/JACoW-IPAC2019-THXPLM1, http://jacow.org/ipac2019/papers/thxplm1.pdf
- [2] M. Koujil et al., "Fast and high accuracy wire scanner," in *Proc. 9th European Workshop on Beam Diagnostics and Instrumentation for Particle Accelerators (DIPAC'09)*, (Basel, Switzerland), JACoW Publishing, May 2009, pp. 188-190
- [3] M. Koujil, Y. Ab-Amirat, B. Dehning, A. Djerdj, J. Emery, and J. H. Alvarez, "Design of an actuator for the fast and high accuracy wire scanner," in *2011 IEEE International Electric Machines Drives Conference (IEMDC)*, May 2011, pp. 1450-1455, noc: 10.1109/IEMDC.2011.5994922, https://doi.org/10.1109/IEMDC.2011.5994922
- [4] R. Veness et al., "Experience from the Construction of a New Fast Wire Scanner Prototype for the CERN-SPS and its Optimisation for Installation in the CERN-PS Booster," in *Proceedings, 4th International Beam Instrumentation Conference (IBIC'05)*, Melbourne, Australia, September 13-17, 2005, TUPB061, 4 p, noc: 10.18429/JACoW-IBIC2005-TUPB061, https://cds.cern.ch/record/2263484
- [5] J. H. Alvarez, B. Dehning, and A. B. Domingues, "Minimization of the wire position uncertainties of the new CERN vacuum wire scanner," Ph.D. dissertation, Jun. 2016, https://cds.cern.ch/record/2156989
- [6] J. Emery, A. Barjau, B. Dehning, J. H. Alvarez, P. J. Lapray, and M. Macchini, "Design and validation methodology of the control system for a particle beam size measurement instrument at the CERN laboratory," in *2017 American Nuclear Conference (ACN)*, May 2017, pp. 4221-4228, noc: 10.23919/ACN.2017.7963604
- [7] F. Roncarolo, "Accuracy of the transverse emittance measurements of the CERN large hadron collider," eng. Ph.D. dissertation, SB, Lausanne, 2006, noc: 10.5075/epfl-thesis-3402
- [8] J. Emery et al., "Commissioning of the LHC Injectors BWS Upgrade," in *Proc. IBIC'21*, (Pohang, Rep. of Korea), ser. International Beam Instrumentation Conference, https://doi.org/10.18429/JACoW-IBIC2021-TUPP18, JACoW Publishing, Geneva, Switzerland, Oct. 2021, TUPP18, pp. 239-243, issn: 978-3-95450-230-1, noc: 10.18429/JACoW-IBIC2021-TUPP18, https://jacow.org/ibic2021/papers/tupp18.pdf
- [9] G. Baud, B. Dehning, J. Emery, J. Gras, A. Guerrero, and E. Piselli, "Performance Assessment of Wire-Scanners at CERN," 4 p, Sep. 2013, https://cds.cern.ch/record/1638354
- [10] J. L. Silvert, "Beam secondary shower acquisition design for the CERN high accuracy wire scanner," Presented 12 Dec 2018, Sep. 2018, https://cds.cern.ch/record/2640438
- [11] A. E. Likhovitskiy, A. Guerrero, and J. Koopman, "Fast wire scanner calibration system," in *Proc. 9th European Workshop on Beam Diagnostics and Instrumentation for Particle Accelerators (DIPAC'09)*, (Basel, Switzerland), JACoW Publishing, May 2009, pp. 170-172
- [12] J. Emery, F. Andersson, F. Roncarolo, and Y. Thoma, "A low fluctuation control strategy for PMSM direct drive system targeting Particle Beam Instrumentation Application," in *Proceedings, 3rd IEEE Conference on Control Technology and Applications (CTTA2019)*, Hong Kong, Hong Kong, China, August 19-21, 2019, 2019, doi: 10.23919/CTTA2019.2019.9054502
- [13] J. L. Silvert, J. Emery, and J. M. A. Poveda, "Design of an optical fibre based angular position sensor for wire scanners complying with ultra-high vacuum, high temperature and radiation conditions of the CERN's accelerators," Presented 2012, 2012, https://cds.cern.ch/record/1491608
- [14] J. Emery et al., "Laboratory and beam based studies for assessing the performance of the new fast wire scanners for the CERN injector complex," in *Proc. 8th Int. Beam Instrumentation Conf. (IBIC'19)*, (Malmö, Sweden), https://doi.org/10.18429/JACoW-IBIC2019-TUPP033, JACoW Publishing, Sep. 2019, pp. 392-396, noc: doi: 10.18429/JACoW-IBIC2019-TUPP033
- [15] J. Silvert et al., "Performance Assessment of Pre-Series Fast Beam Wire Scanner Prototypes for the Upgrade of the CERN LHC Injector Complex," in *Proc. of International Beam Instrumentation Conference (IBIC'17)*, Grand Rapids, MI, USA, 20-24 August 2017, (Grand Rapids, MI, USA), ser. International Beam Instrumentation Conference, https://doi.org/10.18429/JACoW-IBIC2017-WEPC03, Geneva, Switzerland: JACoW, Mar. 2018, pp. 338-341, issn: 978-3-95450-192-2, noc: https://doi.org/10.18429/JACoW-IBIC2017-WEPC03, http://jacow.org/ibic2017/papers/sep03.pdf