

ABSTRACT

A bunched beam intensity measurement system for the CERN Extra Low Energy Antiproton (ELENA) ring, using a cylindrical shoe-box electrostatic pick-up from the existing orbit system [1], is presented. The system has been developed to measure very challenging beam currents, as low as 200nA corresponding to intensities of the order of 10^7 antiprotons circulating with a relativistic beta of the order of 10^{-2} . In this work we derive and show that the turn-by-turn beam intensity is proportional to the baseline of the sum signal and that, despite the AC-coupling of the system, the installed front-end electronics, based on a charge amplifier, not only guarantees the preservation of the bunch shape (up to a few tens of MHz), but also allows for an absolute calibration of the system. In addition, the linearity of the intensity measurements and their independence with respect to average beam position is evaluated using a standard electromagnetic simulation tool. Finally, experimental measurements throughout typical antiproton deceleration cycles are presented and their accuracy and precision are discussed.

THE ELENA RING

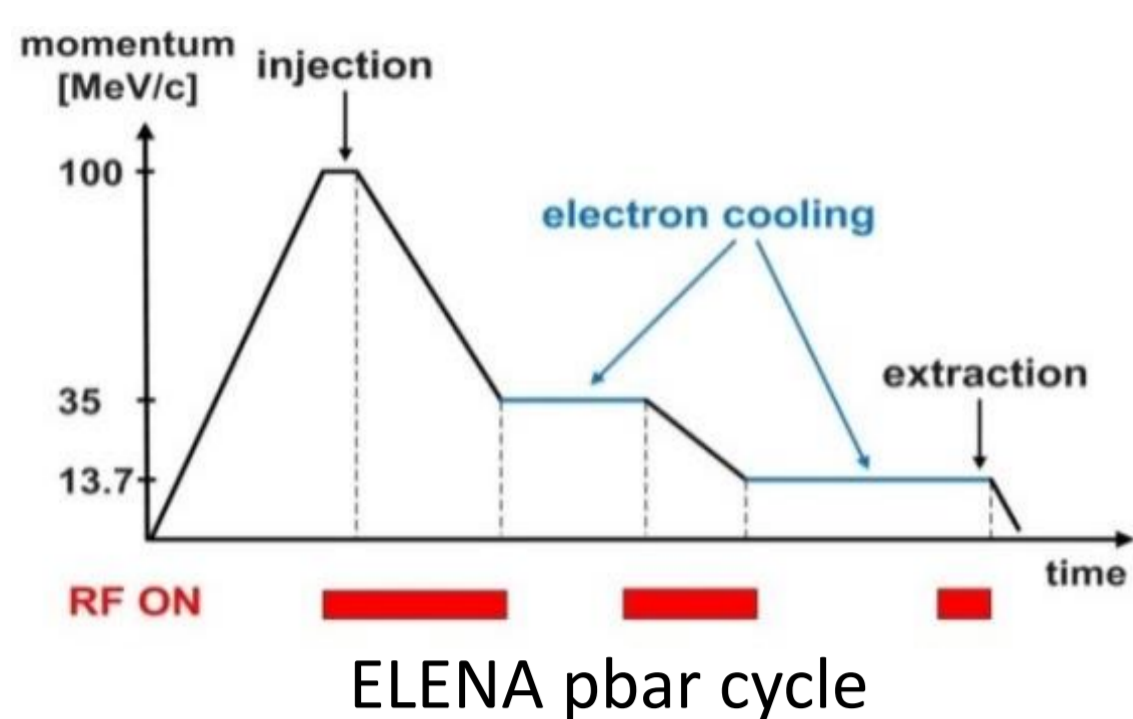

Parameter	Injection	Extraction
Momentum, MeV/c	100	13.7
Kinetic Energy, MeV	5.3	0.1
Revolution frequency, MHz	1.06	0.145
Expected number of particles	$3 \cdot 10^7$	$1.0 \cdot 10^7$
Number of extracted bunches	4 (operationally)	
Extracted bunches length, m/ns	1.3/300	
Circumference, m	30.4	

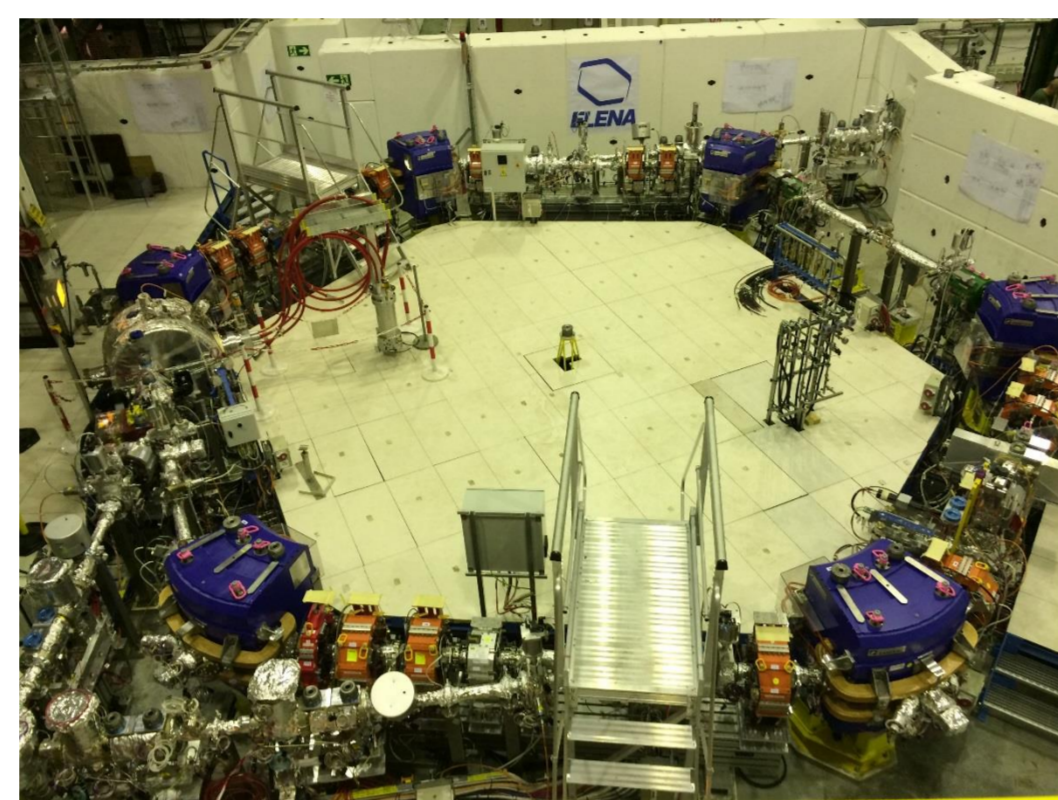

The CERN ELENA, Extra Low Energy Antiproton ring is designed to decelerate anti protons from the CERN AD from 5.3MeV to 100keV ($\beta = 0.015$). It handles $3 \cdot 10^7$ anti protons or, alternatively during commissioning, the same number of H⁺ coming from a local source.

ELECTROSTATIC PICK-UP AS A CHARGE MONITOR

The total beam charge, Q_{beam} , can be calculated by integrating the beam current, i_b , over one revolution period, T_0 , to give

$$Q_{beam} = \int_0^{T_0} (i_b - i_{baseline}) dt = C \cdot \frac{\beta c}{L} \int_0^{T_0} (V_{out} - V_{baseline}) dt. \quad (9)$$

For a circulating beam, after the droop time has passed, no DC is left and the base line is flat (assuming only small and/or slow beam losses when compared to the revolution period). With reference to Figure 4, this means that the area $A2 + A3 = A4$. What is needed is $A1$, which is equal to $A4 + A5$ so, substituting $A4$ by $A2 + A3$, we can see that $A1 = A2 + A3 + A5 = A6$:

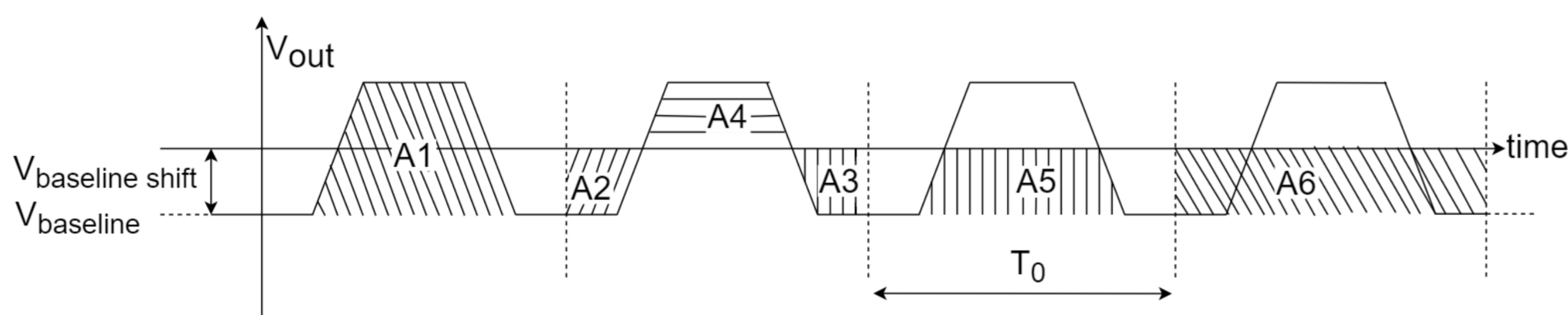

Figure 4: Circulating bunched beam example.

The integral of the output voltage can thus be found as the baseline shift multiplied by the revolution period to give

$$\int V_{out} dt = V_{baseline} \cdot \frac{L_{ELENA}}{\beta c}, \quad (11)$$

where L_{ELENA} is the circumference of the machine. By using this baseline shift to calculate the integral of V_{out} in Eq. (9) the beam intensity, Q_{beam} can be found:

$$Q_{beam} = C \cdot \frac{\beta c}{L} \int V_{out} dt = C_{feedback} \cdot V_{baseline} \cdot \frac{L_{ELENA}}{L}. \quad (12)$$

Equation (12) shows that the intensity measurement conveniently becomes independent of the beam energy and only depends on known constants.

SYSTEM & MEASUREMENT

Head amplifier:

Using a charge (transimpedance) amplifier as the first amplifier (see figure 3), the sensitivity can be increased as the total capacitance, C (normally the sum of the PU capacity, C_{PU} and the load impedance capacity, C_L), becomes essentially $C_{feedback}$:

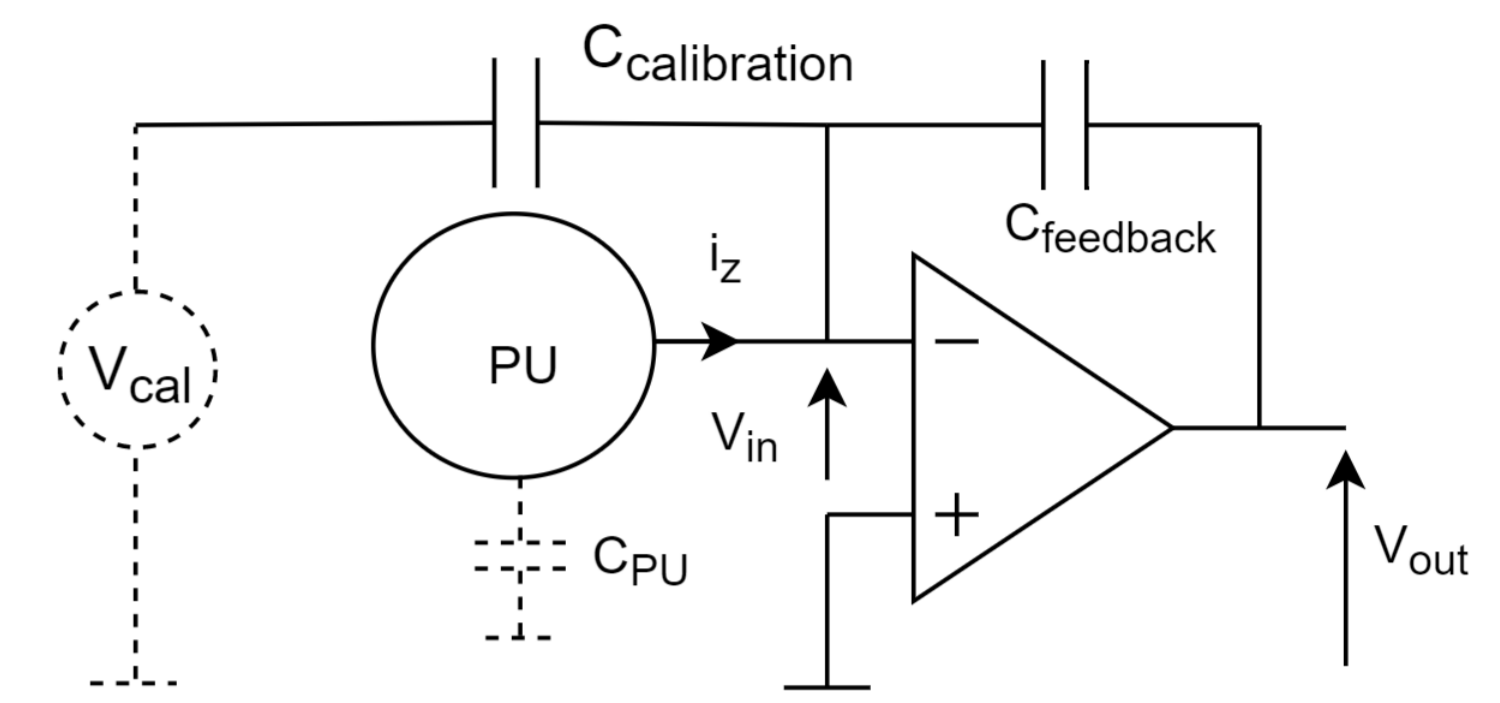

Figure 3: Ideal charge (transimpedance) amplifier, connected to PU and calibration signal.

Simulation:

The integral over time of the output voltage for each beam offset position and β value is calculated in the simulation. A negligible ($<0.1\%$) change in the integrated output voltage is observed with respect to vertical changes in the beam position (for this horizontal PU). The ratio between the time integrated output voltage for the different β values is the ratio of β values themselves, as expected from Eq. (9). Sweeping the number of charges or sweeping the bunch length reveals no non-linearities. These simulations do not include the front-end electronics.

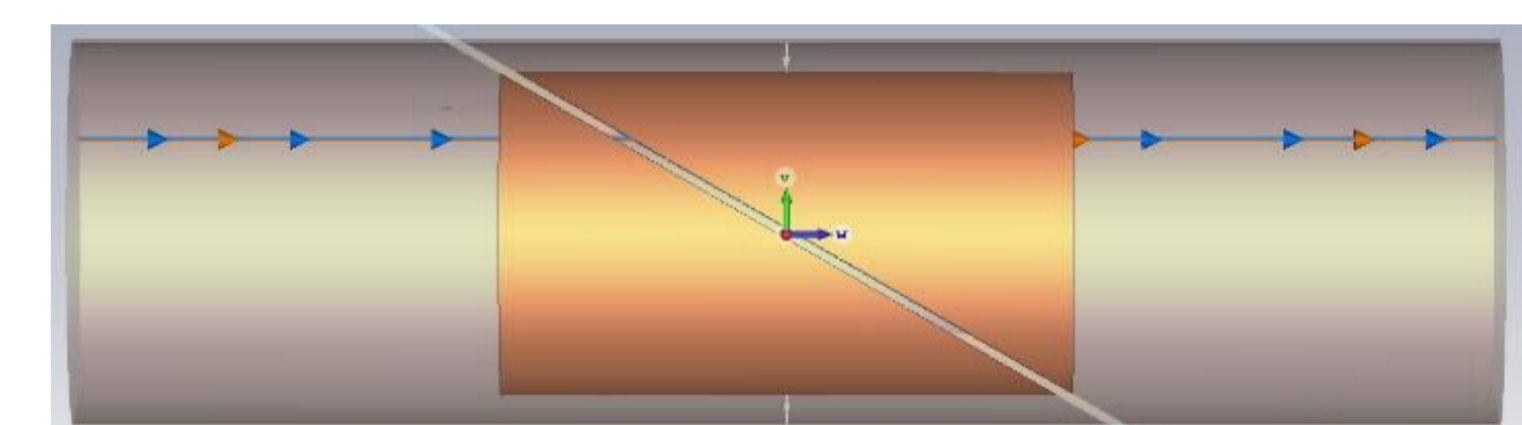

Figure 6: The 3D model of ELENA PU

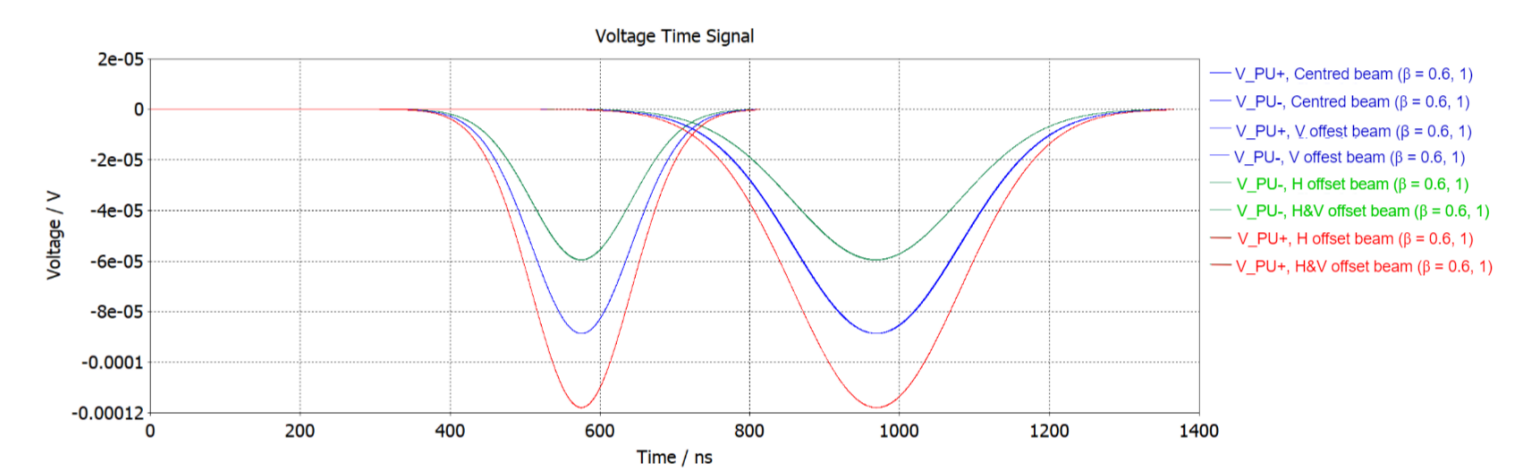

Figure 7: Beam position and β sweep for linear cut PU

Finding the baseline

The baseline shift, can be derived by taking the average of all time samples within a percentile interval. This percentile interval should ideally be set so that only the digitised samples with a signal level corresponding to the baseline (e.g. approximately around -1000 as can be seen in the plot of Figure 5A) is included in the averaging. The settings for the percentile interval are empirically tuned and may depend on the bunch shape. A measurement of the PU sum signal and its cumulative distribution is shown in figure 5. Typically, only the data samples over the 1% percentile and below the 25 to 50% percentiles are taken and averaged to find the baseline.

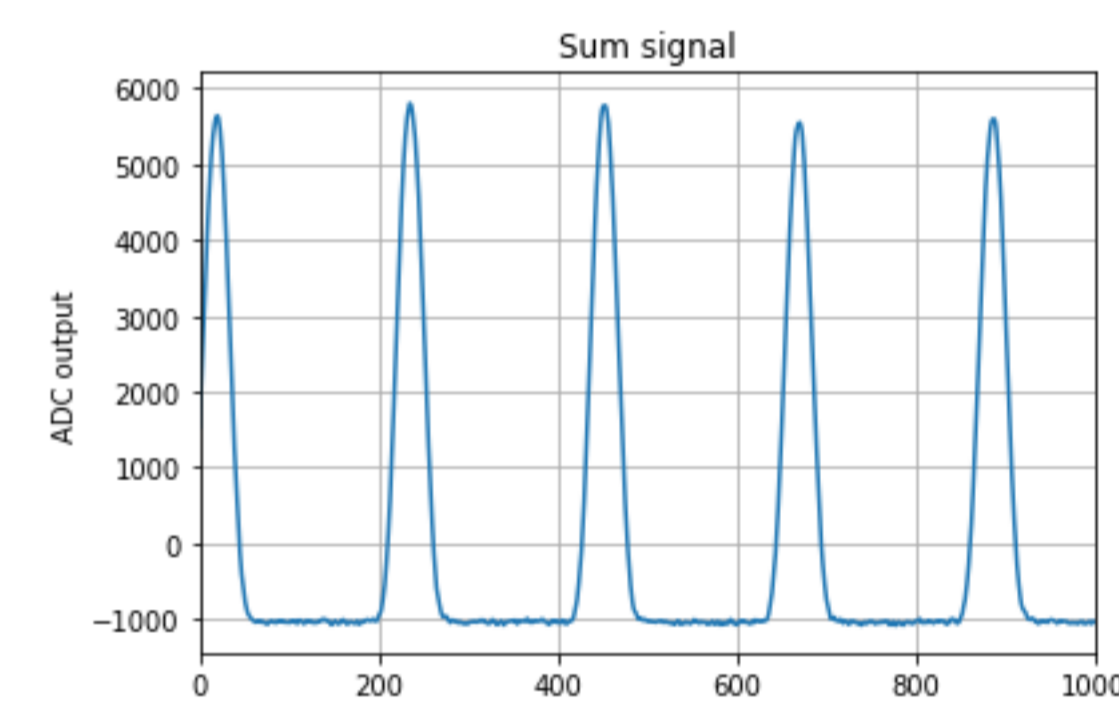

Figure 5A: Time sampled sum signal

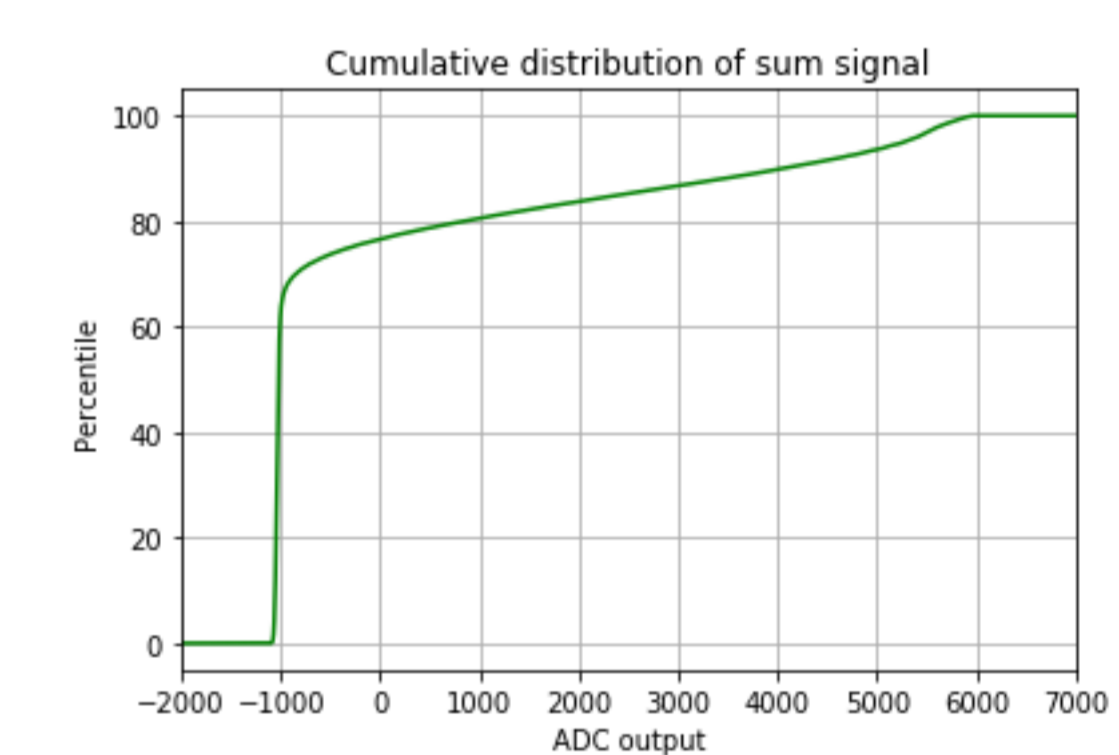

Figure 5B: Corresponding (to 5A) cumulative distribution

Measurement:

This system, installed in ELENA, uses Eq. (12) to provide an intensity measurement, every 1ms, during the ELENA deceleration cycle. A typical output is shown in figure 8, where injection occurs at approximately 2.8s, when the beam coming from the CERN Antiproton Decelerator (AD) is injected. Due to the high pass characteristic of the system, this approach is only valid while the beam is bunched.

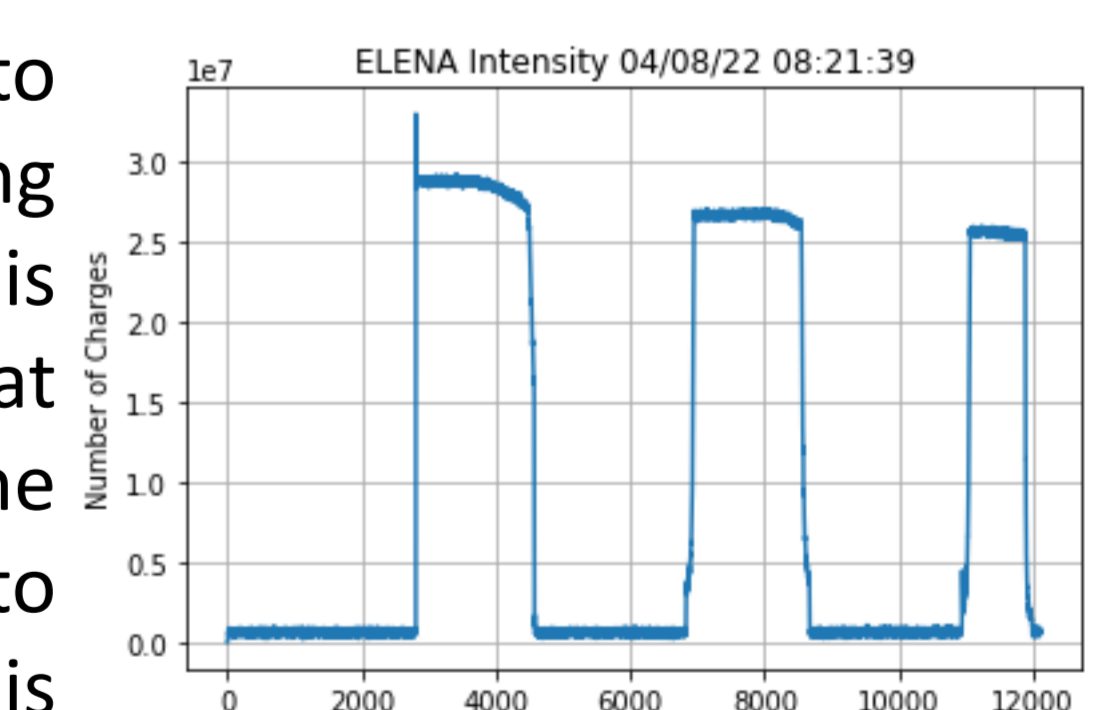

Figure 8: The Intensity IS measured in the bunched periods of the ELENA deceleration cycle

CONCLUSIONS

A system capable of measuring low intensity (few 10^7 charges) antiproton beams, when bunched during the CERN ELENA deceleration cycle, was presented. The system is based on the sum signal from a circular linearly cut electrostatic PU also used by the ELENA orbit system. It has been shown that the baseline shift, caused by the high pass transfer function of the PU can be used to measure the absolute intensity, provided that the system bandwidth covers all relevant harmonics of the bunched beam spectrum. The baseline shift method does not seem to be affected by relativistic effects, as indicated by the CST simulations (only $\beta=1$ and $\beta=0.6$ evaluated). When compared to voltage amplifiers, the use of charge amplifiers as the first amplifier in the chain gives an advantage in terms of sensitivity, though stray capacitance sets a limit to the absolute accuracy of the intensity measurement if the feedback capacitor is taken to very low values. In this system the feedback capacitor is approximately 1pF and the estimated sensitivity gain 30dB.

It has been shown, via simulations, that the position sensitivity of the sum signal is negligible, making an electrostatic PU an interesting intensity sensor. Measurements from the ELENA system were presented. Since no alternative reliable intensity measurement exists in ELENA, not only the operators' task of providing optimized beams for the experiments is difficult, but also our task of validating our measurements becomes challenging. The absolute accuracy of the system is currently limited by the accuracy of the knowledge of the capacitance of the feedback capacitor, including its stray capacitance once mounted and used in the charge amplifier configuration. For these reasons, at present, this system is only used to obtain relative measurements and further studies will be done with the goal of providing absolute intensity measurements.