

DEVELOPMENT OF A PROTOTYPE ELECTRO-OPTIC BEAM POSITION MONITOR AT THE CERN SPS

A. Arteché*, A. Bosco, S. M. Gibson, Royal Holloway, University of London, Egham, UK
N. Chritin, D. Draskovic, T. Lefèvre, T. Levens, CERN, Geneva, Switzerland

Abstract

A novel electro-optic beam position monitor capable of rapidly (< 50 ps) monitoring transverse intra-bunch perturbations is under development for the HL-LHC project. The EO-BPM relies on the fast optical response of two pairs of electro-optic crystals, whose birefringence is modified by the passing electric field of a 1 ns proton bunch. Analytic models of the electric field are compared with electromagnetic simulations. A preliminary opto-mechanical design of the EO-BPM was manufactured and installed at the CERN SPS in 2016. The prototype is equipped with two pairs of 5 mm cubic LiNbO₃ crystals, mounted in the horizontal and vertical planes. A polarized CW 780 nm laser in the counting room transmits light via 160 m of PM fibre to the SPS, where delivery optics directs light through a pair of crystals in the accelerator vacuum. The input polarization state to the crystal can be remotely controlled. The modulated light after the crystal is analyzed, fibre-coupled and recorded by a fast photodetector in the counting room. Following the recent installation, we present the detailed setup and report the latest status on commissioning the device in-situ at the CERN SPS.

MOTIVATION AND CONCEPT

An electro-optic beam position monitor (EO-BPM) is being developed for high frequency, intra-bunch measurements at the High-Luminosity Large Hadron Collider [1]. The main aim of the new instrument is to determine the mean transverse displacement along each $4\sigma = 1$ ns proton bunch, with a time resolution of < 50 ps. Existing head-tail monitors based on stripline BPMs are capable of measuring intra-bunch instabilities, with a bandwidth of 3–4 GHz that is limited by the pick-ups, cables and acquisition system [2]. In contrast, an EO-BPM is essentially a conventional button-BPM in which the pick-ups have been replaced with electro-optic crystals, to target bandwidths of 10–12 GHz or more, due to the fast optical response of the crystal in the transient electric field of the bunch.

The electro-optic response is measured using polarized light from a continuous wave, 780 nm laser source, housed away from the accelerator in the low radiation, accessible environment of a counting room. The light is conveyed in 160 m PM delivery fibre to collimation and polarization optics at each pick-up, and transmitted through the crystal, parallel to the particle beam direction. The light that emerges after the crystal typically has a different polarization state, due to the natural birefringence of the crystal. When the particle bunch passes, the electric field penetrates the crystal

and via the Pockels effect, induces a change in the birefringence of the crystal, thus rapidly modifying the polarization state of the emerging light. An analyzer is placed after the crystal and the subsequent intensity of light is coupled into a return SM fibre and recorded by a fast photodetector. By taking the difference signal between pick-ups on the opposite sides of the beam pipe, the transverse displacement along the bunch can be deduced. In an alternative interferometric layout, coherent light is exploited to optically suppress the common mode signal, such that the detector directly measures the difference signal between the two pick-ups [1].

As a proof of these concepts, a prototype EO-BPM has been developed and was recently installed for tests in the CERN SPS. The following sections report on the detailed opto-mechanical design of the electro-optic pick-ups that were installed, including electromagnetic simulations of the geometry to assess the electric field strength penetrating the crystal. The installed layout in the CERN SPS is reviewed, including the fibre coupled, remotely controlled polarization optics. Finally, experimental validation of the sensitivity of the crystal to electric fields equivalent to those expected from the simulation is presented.

ELECTRO-OPTIC PICK-UP DESIGN AND SIMULATION

Prototype Opto-Mechanical Design

The conceptual design of the EO-BPM has compact, fibre-coupled optics directly mounted to the eo pick-up. For the CERN SPS prototype, however, a more flexible approach was decided, to enable reconfiguration and investigation of the polarization states. Therefore the fibre-coupled collimation and polarization optics were mounted on a small external breadboard adjacent to the pick-up, with light coupled into and out of the pick-up by a free space laser beam. The opto-mechanical design of the pick-up [3] is illustrated in Figure 1, showing the superposed path of the laser beam.

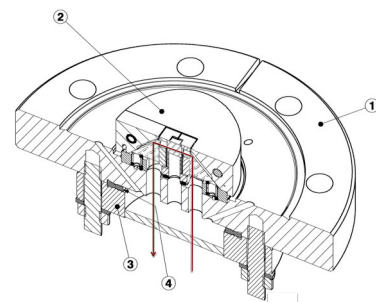

Figure 1: Laser beam trace inside the eo pick-up: 1. Flange. 2. Button. 3. Viewing port. 4. Copper gasket.

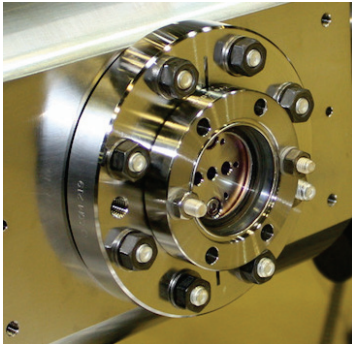

Figure 2: External view of pick-up in BPM body.



Figure 3: Pick-up components: ceramic holders, prisms and crystal.

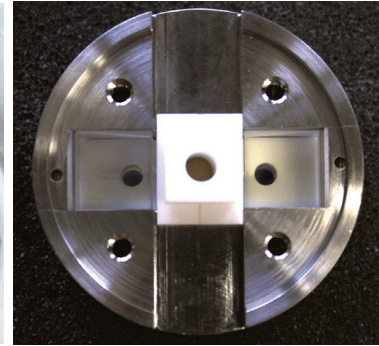

Figure 4: Top view shows reflected path through crystal.

Four such pick-ups have been installed in the CERN SPS and each consists of three components connected by copper gaskets: a button, an external flange and a viewing port, as in Figures 2–4. The incident laser beam is reflected using two right-angled prisms, surrounding a $\text{MgO}_2\text{:LiNbO}_3$ 5 mm cubic crystal, that is held within a ceramic support of mica. The incoming beam is linearly polarized and the passing proton bunch Coulomb field interacts over the crystal resulting in a polarisation modulation in the output laser beam. An anti-reflection coated viewport provides the interface between the vacuum and the free space beam optics.

Analytic Model

The pick-up signal is based on the linear electro-optic Pockels effect, which modifies the refractive indices of the crystal traversed by the polarized laser beam, in proportion to the induced electric field penetrating the crystal. An analytic model was developed as a function of the bunch and crystal parameters to study the pickup performance and design.

The Coulomb field time profile at a radius, r_0 , from the proton beam axis is given by the convolution of a single particle electric field, E_p , and the charge density function, $\rho(t)$, of the bunch:

$$E_{\text{bunch}}(r_0, t) = E_p(r_0, t) * \rho(t). \quad (1)$$

The charge density is typically defined as a Gaussian distribution, $\rho(t) = N_p e^{-t^2/2\sigma^2} / \sqrt{2\pi}$, where N_p is the number of protons in the bunch, centred on $t = 0$. When dealing with relativistic proton bunches ($v/c \rightarrow 1$), the particle electric field, E_p , depends upon the proton charge, e_0 , the relativistic γ , and the crystal dielectric constant, ϵ , as follows [4]:

$$E_p(r_0, t) = \frac{\gamma e_0}{4\pi\epsilon} \cdot \frac{r_0}{(r_0^2 + \gamma^2 v^2 t^2)^{3/2}}. \quad (2)$$

When the Coulomb field is propagating in free space, $\epsilon = \epsilon_0$. At the point where the Coulomb field reaches the crystal face, the propagation gives rise to a discontinuity at the interface position between vacuum and the dielectric crystal sample. The impact on the penetration is given by applying the new dielectric constant over equation 2, considering $\epsilon = \epsilon_0 \epsilon_z$.

For LiNbO_3 , in the SPS bunch power spectrum scenario, it can be assumed $\epsilon_z = 28$ [5].

Applying the Fourier transform properties over equation 2, the time profile can be obtained as an inverse Fourier transform of the profile in the frequency ω domain:

$$E_{\text{bunch}}(r_0, t) = \frac{N_p e_0}{2\sqrt{2}\pi^{3/2}\gamma v^2 \epsilon} \cdot \text{FT}^{-1} \left\{ e^{-\frac{1}{4}\sigma^2 \omega^2} \omega K_1 \left[\frac{r_0 \cdot \omega}{v\gamma} \right] \right\}, \quad (3)$$

where K_1 is the modified Bessel function of the second type. The maximum electric field value E_{max} that takes place at $t = 0$, corresponds with $\omega = 0$ in the domain profile. Expanding equation 3 around the maximum, results in $K_1[r_0\omega/\gamma\beta] \approx \gamma\beta/r_0\omega$. By substitution, an expression for the maximum Coulomb field is obtained:

$$E_{\text{bunch}}(r_0, t = 0) = E_{\text{max}} = k \cdot \frac{N_p}{\beta\sigma} \cdot \frac{1}{r_0} \quad (4)$$

with $\beta = v/c$, thereby:

$$k = \frac{e_0}{2\sqrt{2}\pi^{3/2}c\epsilon_0}. \quad (5)$$

Considering $\beta \approx 1$ for SPS proton bunches, the maximum electric field at a given position r_0 depends strictly upon the charge and the bunch length through σ . Equation 4 accurately predicts the maximum strength of the Coulomb field as it propagates in vacuum up to the beam pipe radius. Applying equation 4 at the interface would generate a step given by a factor $1/\epsilon_z$ when propagating through the dielectric medium.

Electromagnetic Simulation

A powerful numeric electromagnetic simulation has been carried out in CST studio to clarify the interaction of the propagating particle bunch electric field at the crystal interface and how the field propagates inside the dielectric. This study is vital to estimate the expected extent of the electro-optic modulation, since the effect is linearly dependent on the penetrating electric field strength.

Figure 5 illustrates the simplified layout of the simulated button; components that were considered irrelevant were removed to optimise the simulation. The simulated pieces

were the button with a simplified shape, the crystal and the mica holder. The crystal cube had no electrical contacts and the side facing the proton bunch is non-metalized. The geometry shown in Figure 5 was simulated by applying the parameters in Table 1 that are relevant for the CERN SPS.

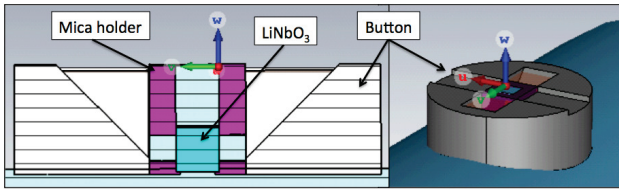

Figure 5: Transversal section and general view of the electro-optic button pickup in the CST visual interface.

Table 1: SPS Bunch and LiNbO₃ Sample Parameters

Bunch intensity	1.15×10^{11}	protons per bunch
Bunch length = 4σ	1	ns
SPS beam energy	450	GeV
Pipe radius	66.5	mm
Crystal dimension	cubic 5x5x5	mm

Two cases were simulated: the crystal was first removed to explore the penetration of the E-field into the cavity that is, in the second case, occupied by the LiNbO₃ crystal. The eo crystal is an anisotropic material that is characterised by three dielectric constants [5], with ϵ_z parallel to the radial dimension and $\epsilon_x = \epsilon_y$. Figure 6 shows how the maximum electric field varies with the radial position for both the numeric CST simulation and the analytic prediction of Equation 4. The beam pipe radius for the SPS prototype is 66.5 mm, and the vertical dashed lines depict the radial positions of two faces of the 5 mm cubic crystal.

The upper plot of Figure 6 shows the radial E-field penetration through the metallic slot of the pick-up and into the empty cavity for the case when the crystal is removed. The observed decay of the electric field in the cavity is explained by the impedance of the slot aperture. With the crystal in place, the electric field drops rapidly in the analytic prediction due to the $1/\epsilon_z = 1/28$, factor of the dielectric constant and remains below 1 kV/m. The numerical simulation, as detailed in Table 2, also converges to the analytic model inside the crystal, though the first few points are considered an unphysical result of the numerical approach at the discontinuity of the interface. The laser beam passes through the crystal centre, corresponding to a radial position $r_0 = 68.8$ mm. Thus the electric field strength responsible for the electro-optic modulation is estimated to be ~ 0.7 kV/m, which implies a per mil signal / background detection.

Table 2: Electric-Field Results Inside the Crystal.

Radial position [mm]	67.5	68	69	70
Electric field [kV/m]	0.936	0.853	0.664	0.442

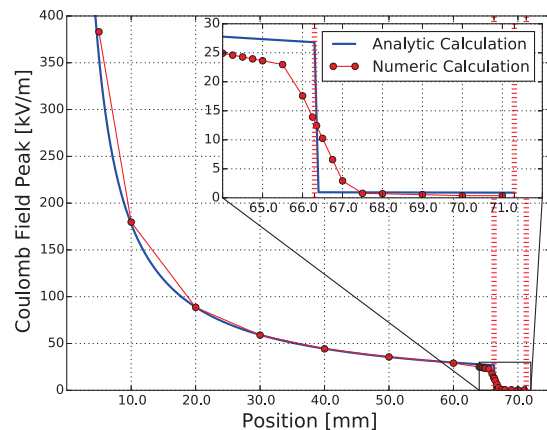
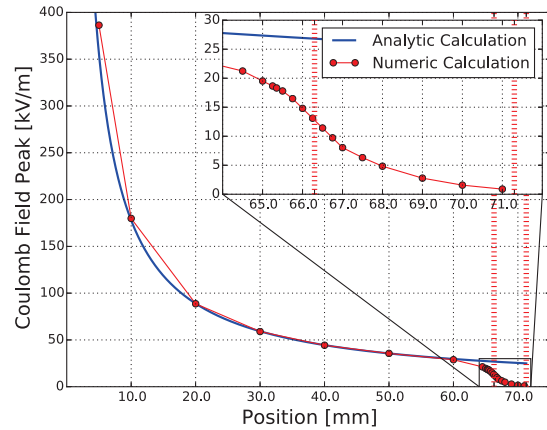

Figure 6: Coulomb field radial penetration into: the vacant pick-up cavity (top); and with the crystal in place (bottom).

PROTOTYPE EO-BPM AT THE CERN SPS

In 2016 a prototype EO-BPM was installed at the CERN SPS adjacent to the existing HT monitor [1]. The prototype includes four pick-ups with an identical mechanical design as presented in Figures 1–4. The opposing pair of

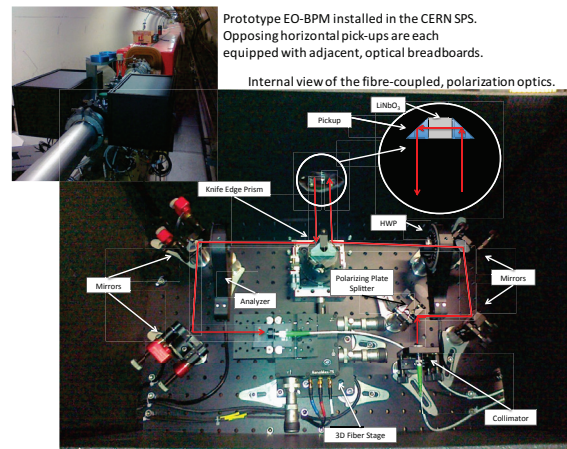

Figure 7: Fibre-coupled collimation optics control and analyze the polarization before and after the eo pick-up.

3% doped MgO₂ LiNbO₃ crystals in the vertical plane were metallic-coated on the sides facing the beam, whereas the pair in the horizontal plane were uncoated on the sides facing the beam, to check THz radiation penetration into the crystal. The horizontal pick-ups was initially equipped with two breadboards, each containing fibre-coupled, radiation tolerant, remote-controlled polarization state and analyzer optics as shown in Figure 7, for flexible, online reconfiguration and investigations of the polarization state. 160 m of PM fibre conveys light from a 780 nm laser to the collimator shown. A knife edge prism diverts light into and out of the EO pick-up. The modified polarization state is analyzed, fibre coupled, and monitored by a distant fast photodetector.

CRYSTAL RESPONSE MEASUREMENTS

Optical bench tests were performed to validate the detection method when approaching realistic conditions. Figure 8 shows the setup that recreates the pick-up configuration, with automated polarization control optics surrounding the eo-crystal, in a HV safety case. A pulse voltage was ap-

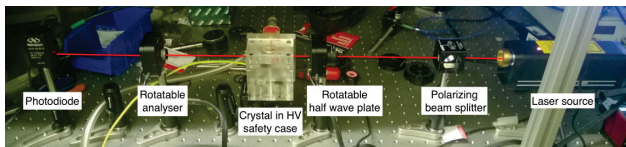

Figure 8: Crystal characterisation setup.

plied across the crystal while linearly polarized light was normally incident on the face of the crystal, with a 45° axial orientation. Even for a pulse of 10 V applied across a 5 mm MgO₂:LiNbO₃ crystal, a signal is detectable by a photodiode after the crossed analyzer, as in Figure 9. Azimuthal

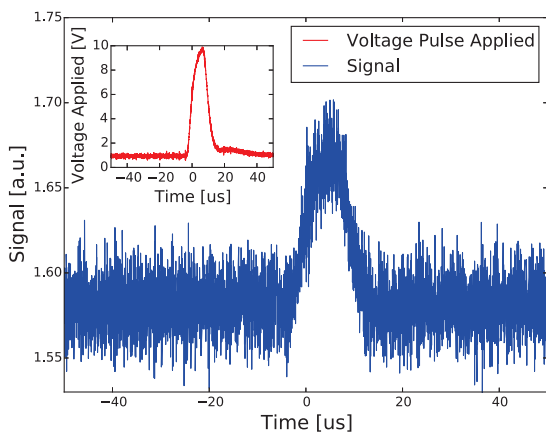

Figure 9: Optical response to an applied low voltage pulse.

scans of the analyzer enable the polarization state due to the natural birefringence of the crystal to be evaluated, as in Figure 10. By inserting a Soleil-Babinet compensator after the crystal, and before the analyzer, the polarization state can be readjusted to optimise the signal. By this method and a model of the polarization state, it was confirmed that

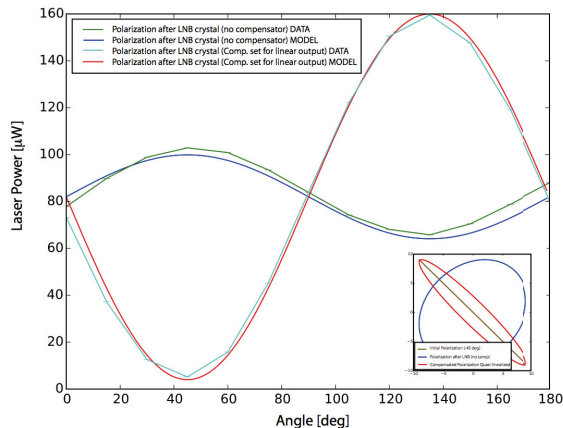

Figure 10: Natural and linearised polarization states.

the maximum signal is obtained by setting the polarization state after the crystal to be circular. For the CERN SPS EO-BPM, a narrow linewidth (<200 kHz), tunable laser will be installed, that enables the natural birefringence effect to be modified by fine adjustment of the wavelength, to optimise the working point of the instrument.

SUMMARY AND OUTLOOK

A prototype EO-BPM was recently installed in the CERN SPS, with remote controlled, fibre-coupled polarization and analyzer optics. The strength of the electric field penetrating the crystal has been evaluated by electromagnetic simulations. Optical measurements of the crystal response confirm applied voltage pulses of the expected field strength are detectable. Methods to adjust the working point of the instrument have been developed and a narrow linewidth, tunable laser will be installed soon for initial beam tests.

ACKNOWLEDGEMENTS

We thank the CERN vacuum group and SPS team for their support. Work funded by UK STFC grant ST/N001583/1, JAI at Royal Holloway University of London and CERN.

REFERENCES

- [1] S. M. Gibson et al., “High frequency electro-optic beam position monitors for intra-bunch diagnostics at the LHC”, WEDLA02, Proc. of IBIC 2015, Melbourne, Australia.
- [2] T. Levens et al., “Recent developments for instability monitoring at the LHC”, THAL02, Proc. of IBIC 2016, Barcelona, Spain.
- [3] P. Y. Darmedru, “Conception mécanique d’un instrument de mesure de position d’un faisceau de particules”, CERN EN report, Groupe 2A04, 2015.
- [4] J. D. Jackson “Classical Electrodynamics”, John Wiley and sons, Inc., 3rd edition, 1999.
- [5] R. S. Weis and T. K. Gaylord, *Appl. Phys. A* 37, p191-203 (1985).