

BEAM INSTRUMENTATION, CHALLENGING TOOLS FOR DEMANDING PROJECTS

A SNAPSHOT FROM THE FRENCH ASSIGNED NETWORK

F. Poirier¹, T. Durand¹, C. Koumeir¹, C. Jamet², S.M. Ben Abdillah³, N. Delerue³, H. Guler³, T. Adam⁴, E. Bouquerel⁴, C. Maazouzi⁴, F. R. Osswald⁴, C. Thiebaut⁵, M. Verderi⁵, L. Daudin⁶, A. Husson⁶, B. Lachacinski⁶, J. Michaud⁶, B. Cheymol⁷, D. Dauvergne⁷, M.-L. Gallin-Martel⁷, R. Molle⁷, C. Peaucelle⁷,

¹ ARRONAX, Saint-Herblain, ² GANIL, Caen, ³ IJCLAB, Orsay, ⁴ IPHC, Strasbourg, ⁵ LLR, Palaiseau, ⁶ LP2I, Gradignan, ⁷ LPSC, Grenoble, France.

Beam Instrumentation Network

“An accelerator is as good as its diagnostics”*

HIAT 2022

Introduction: Beam instrumentation

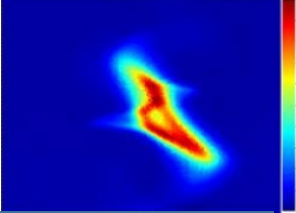

- Performances of the accelerators depends crucially on the capacities to measure, monitor and control the properties of particle beams.
 - There is a demand, for more and more stringent high energy beams, small emittance, strict tolerances which are imposed to modern accelerators. It can also be a combination with high intensity/low energy or high power and low cycle or intensity range.
 - A (very) good understanding of the beam instrumentation is essential to reach the expected performances
 - Diagnostics developments take time. They can follow a development pattern
 - in phase (or not) with the accelerator developments
 - iterative
 - But some diagnostics are not systematically designed and put in place before the operation of the accelerator.
 - Beam Instrumentation depends necessarily (and not surprisingly) on the skills of the experts (from physicists, Engineers, technicians and operators)

Introduction: Beam instrumentation

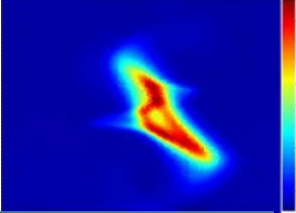

- Performances of the accelerators depends crucially on the capacities to measure, monitor and control the properties of particle beams.
 - There is a demand, for more and more stringent high energy beams, small emittance, strict tolerances which are imposed to modern accelerators. It can also be a combination with high intensity/low energy or high power and low cycle or intensity range.
 - A (very) good understanding of the beam instrumentation is essential to reach the expected performances
 - Diagnostics developments take time. They can follow a development pattern
 - in phase (or not) with the accelerator development
 - iterative
 - But some diagnostics are not systematically designed and put in place before the operation of the accelerator.
 - Beam Instrumentation depends necessarily (and not surprisingly) on the skills of the experts (from physicists, Engineers, technicians and operators)
- Beam instrumentation here:
 - Measurements instrumentation (sensors).
 - Associated electronics, Mechanical material and devices which do not make measurements
 - High level applications (signal treatment & Com. Cont. software, and usage methodologies)

Beam Instrumentation force

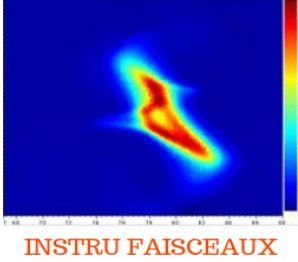

- French institutes (Here CNRS/IN2P3 and CEA) support and participate in various present and future facilities on the national territory and international accelerators
 - Experts of beam instrumentation are involved.
 - Experts here are scattered in various laboratories
- A beam instrumentation network has thus been put in place
 - <https://tech-news.in2p3.fr/reseau-instrumentation-faisceau/>

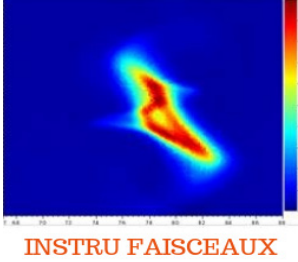

Mission of the network

- Network animates, coordinates, encourages, and promotes the exchange and interdisciplinary initiatives on beam instrumentation
- Ease communication and skills and/or information exchange between its members
- Takes an active part in scientific and technological monitoring
- Identifies and promotes the skills and expertise of the Network by updating pools of experts
- Develops proposals relating to its missions
- Identifies and help promote research themes
- Help develop training if necessary
- Promote the work of young collaborators - Students

French Beam Instrumentation Network

Coord.: F.Poirier Arronax, C.Peaucelle LPSC, + CC-IN2P3

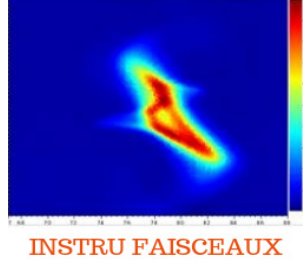

- Created in 2018
 - Almost 40 members, 12 labs/institutes
- More than 22 meetings:
 - Wide range of subjects:
 - From specific diagnostics (BPM, Emittance-meter, profilers,...)
 - Diagnostics for leptons and ions machines
 - Test-benches, command-control soft,...
 - Zoom meeting
 - Members:
 - Eg: “Review of Emittance-meter in France”, “Thin detector damages”
 - Invited talks:
 - “Experience from the European Instrumentation Network ARIES-ADA”, P.Forck
 - Next session in july: “Diags at LHC”
 - Last annual meeting over 2 days in April 2022 at ijCLab, Orsay
 - 15 talks + site visit
- Working Group on dedicated subject (Survey, Overview)
- Participated in:
 - “2020-30 IN2P3 prospective exercise”
 - Deployment of diags on several accelerators (see later)
 - Devices (elec. Cards, power supply)

Laboratoires /Instituts

- IJCLab
- CENBG
- LLR
- LPC Caen
- LPSC
- IPHC
- GANIL
- Arronax
- LAPP
- Subatech
- ESRF
- CEA/IRFU

1

Présentations

Posters

GANIL

IPHC

LPSC

ARRONAX

Visites IPNL

IPNL

HIAT 2022

Survey - snapshot

Working group coord.: C.Peaucelle LPSC, F.Poirier Arronax

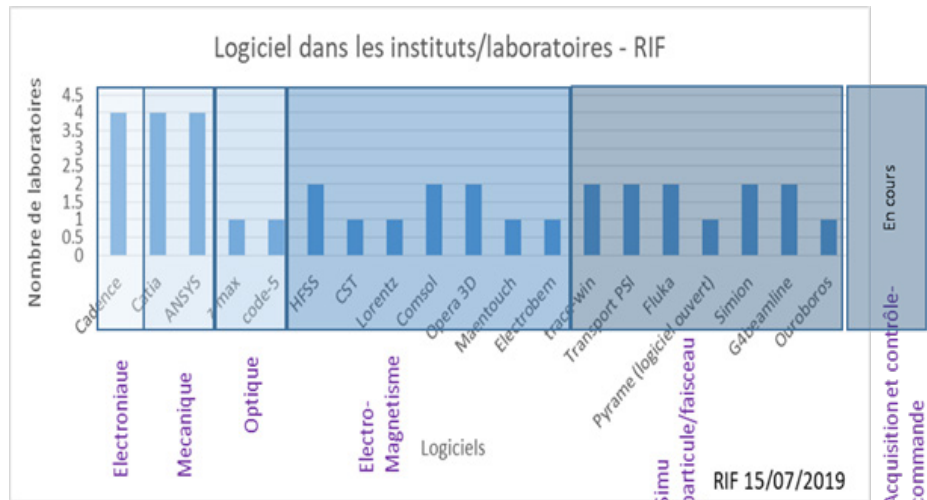
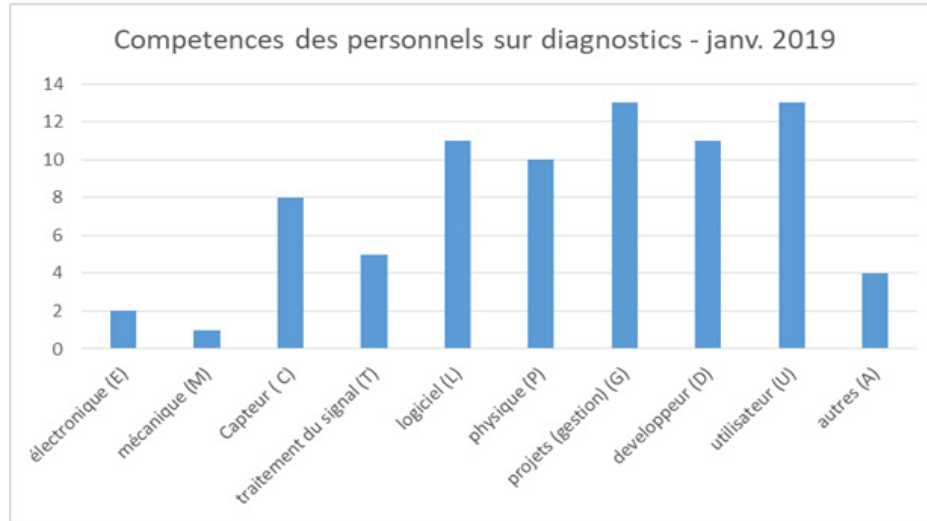
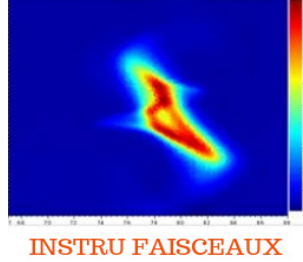

• Wide set of skills:

• Technical:

- Sensors
- Physics
- Electronics
- Softwares
- Signal treatments

• Administrative:

- Project (management)

• Participation at several Diag. phase

- Dvt
- users

• Needs of software knowledge for the Beam Instr. dvt in various domain:

- Optics
- Electronics,...

Diagnostics Development phases

Initial work: N.Delerue, IJCLab

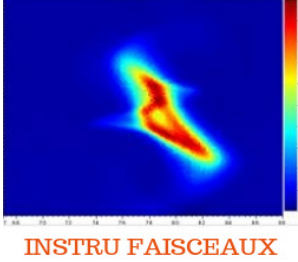

- Diags dvt take time:
 - R&D
 - Generic validation: proto
 - Specific Validation: ope.
- Diags do also participate in the phase of the accelerators
 - safety regulation for commissioning authorisation
 - Commissioning,
 - Std operation
 - Start-up
 - Regular scheduled runs

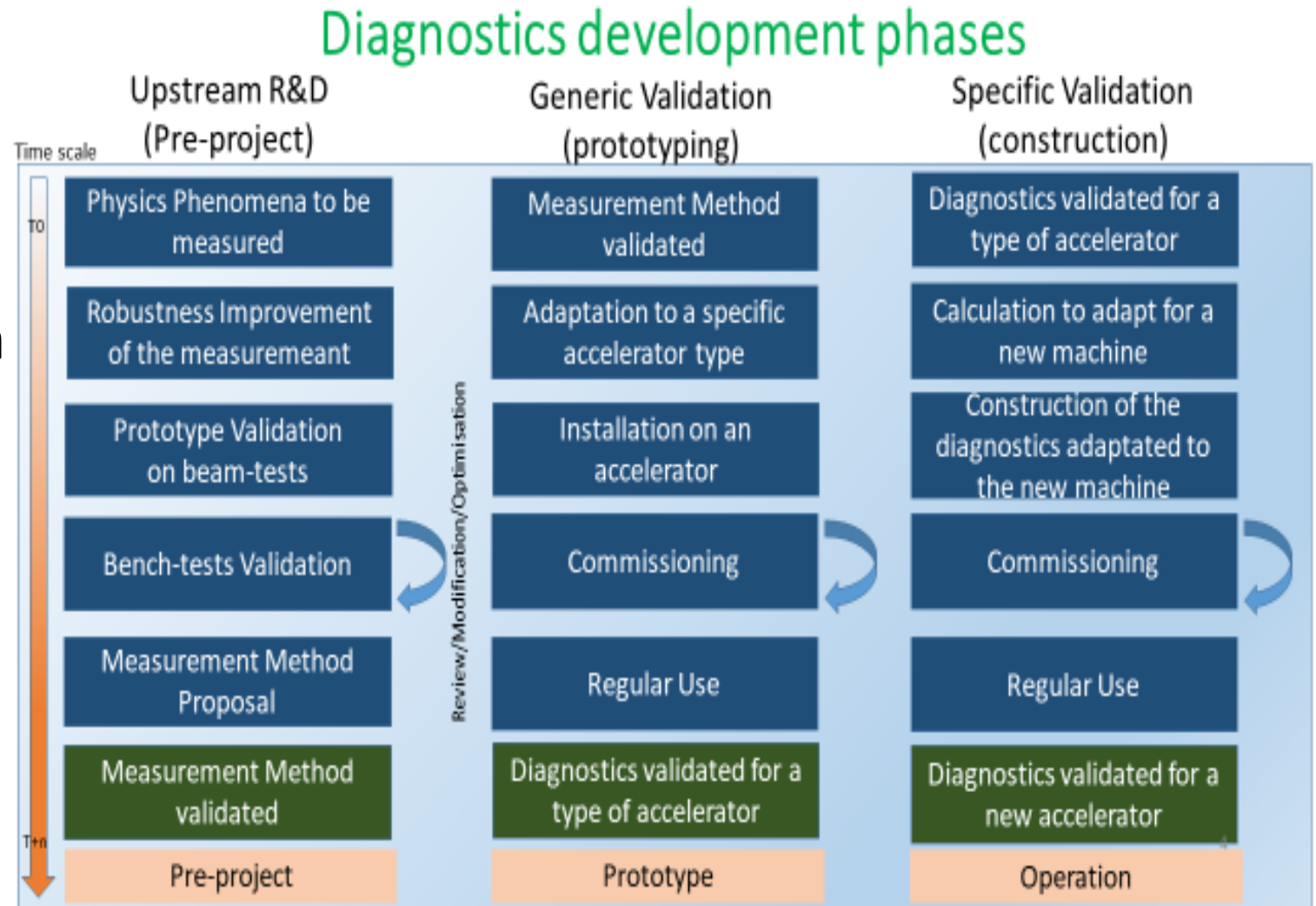

Accelerators

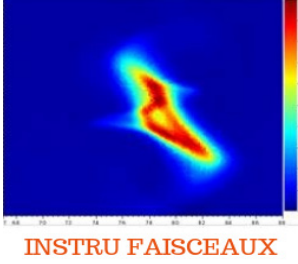

- Experts of the network are involved in a large range of instrumentations,
- For this presentation, We focused on Beam inst. on the following ions machine (not exhaustive):
 - ARRONAX – 10 years of operation
 - SPIRAL2 - commissioning
 - DESIR - project
 - NEWGAIN - project
 - MYRRHA – project (in the paper only)
- Involvement in other ion machine also:
 - See emittance-meter part

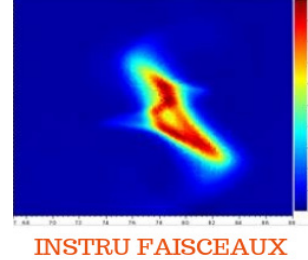

Accelerators

- Experts of the network are involved in a large range of instrumentations,
- For this presentation, We focused on Beam inst. on the following ions machine (not exhaustive):
 - ARRONAX – 10 years of operation
 - SPIRAL2 - commissioning
 - DESIR - project
 - NEWGAIN - project
 - MYRRHA – project (in the paper only)
- Involvement in other ion machine also
 - See emittance-meter part

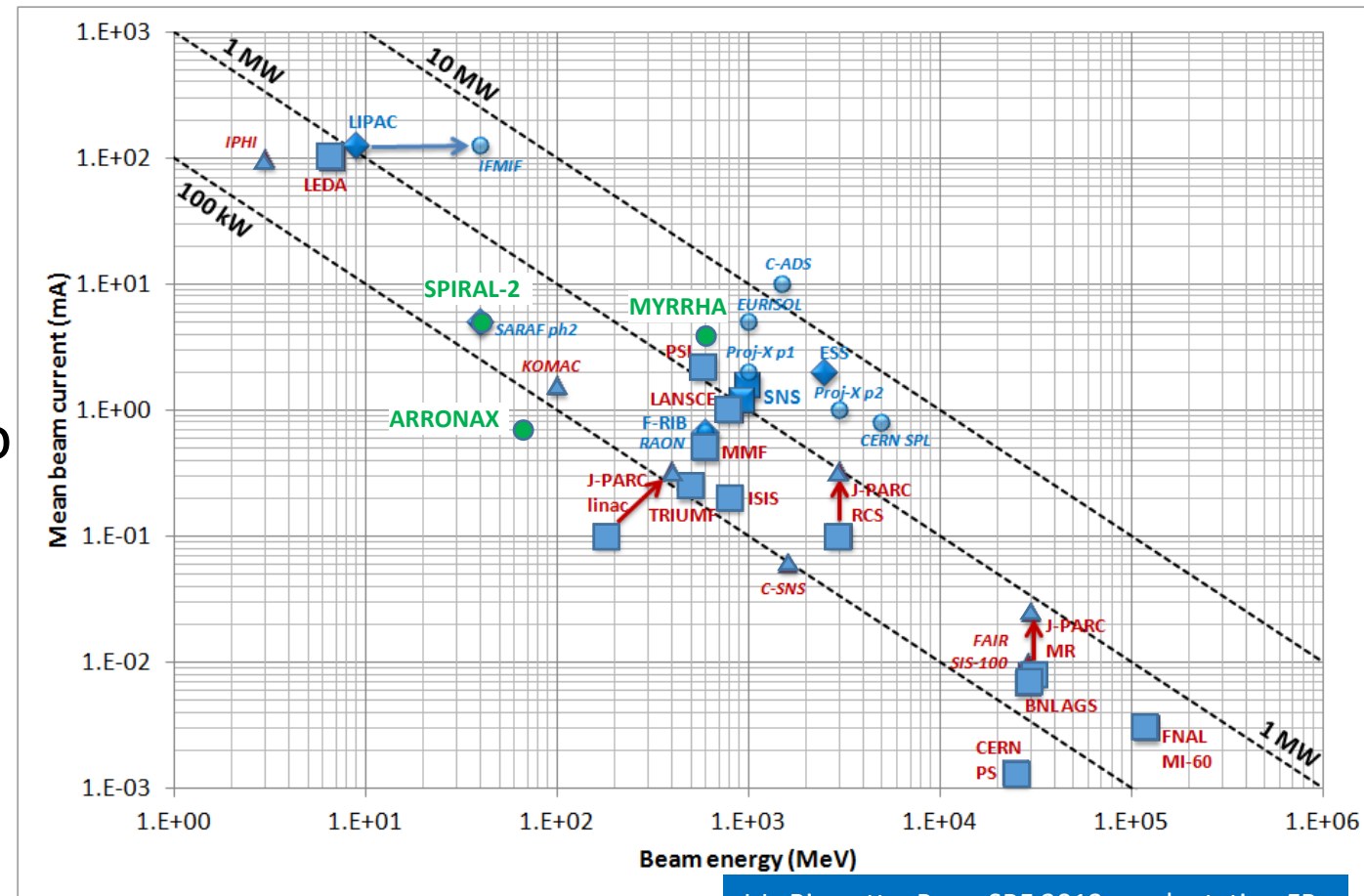

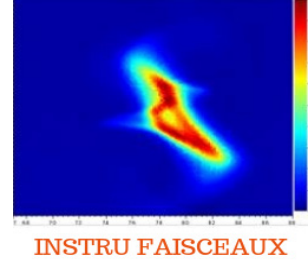

Accelerators

- Experts of the network are involved in a large range of instrumentations,
- For this presentation, We focused on Beam inst. on the following ions machine (not exhaustive):
 - ARRONAX – 10 years of operation
 - SPIRAL2 - commissioning
 - DESIR - project
 - NEWGAIN - project
 - MYRRHA – project (in the paper only)
- Involvement in other ion machine also
 - See emittance-meter part

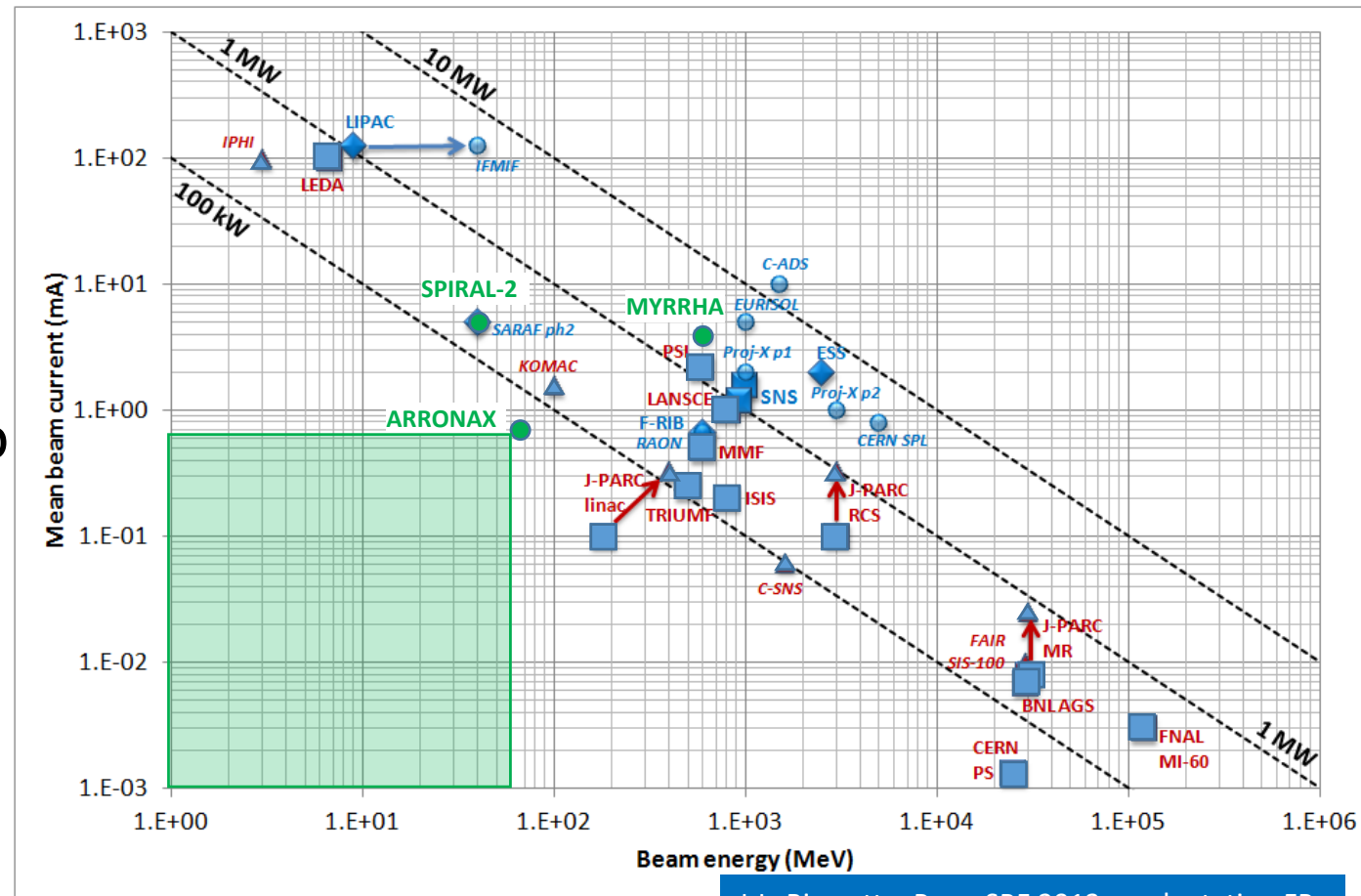

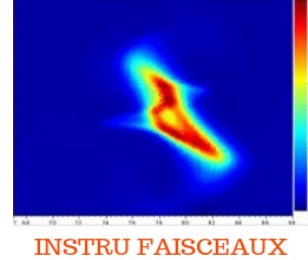

Accelerators

- Experts of the network are involved in a large range of instrumentations,
- For this presentation, We focused on Beam inst. on the following ions machine (not exhaustive):
 - ARRONAX – 10 years of operation
 - SPIRAL2 - commissioning
 - DESIR - project
 - NEWGAIN - project
 - MYRRHA – project (in the paper only)
- Involvement in other ion machine also
 - See emittance-meter part

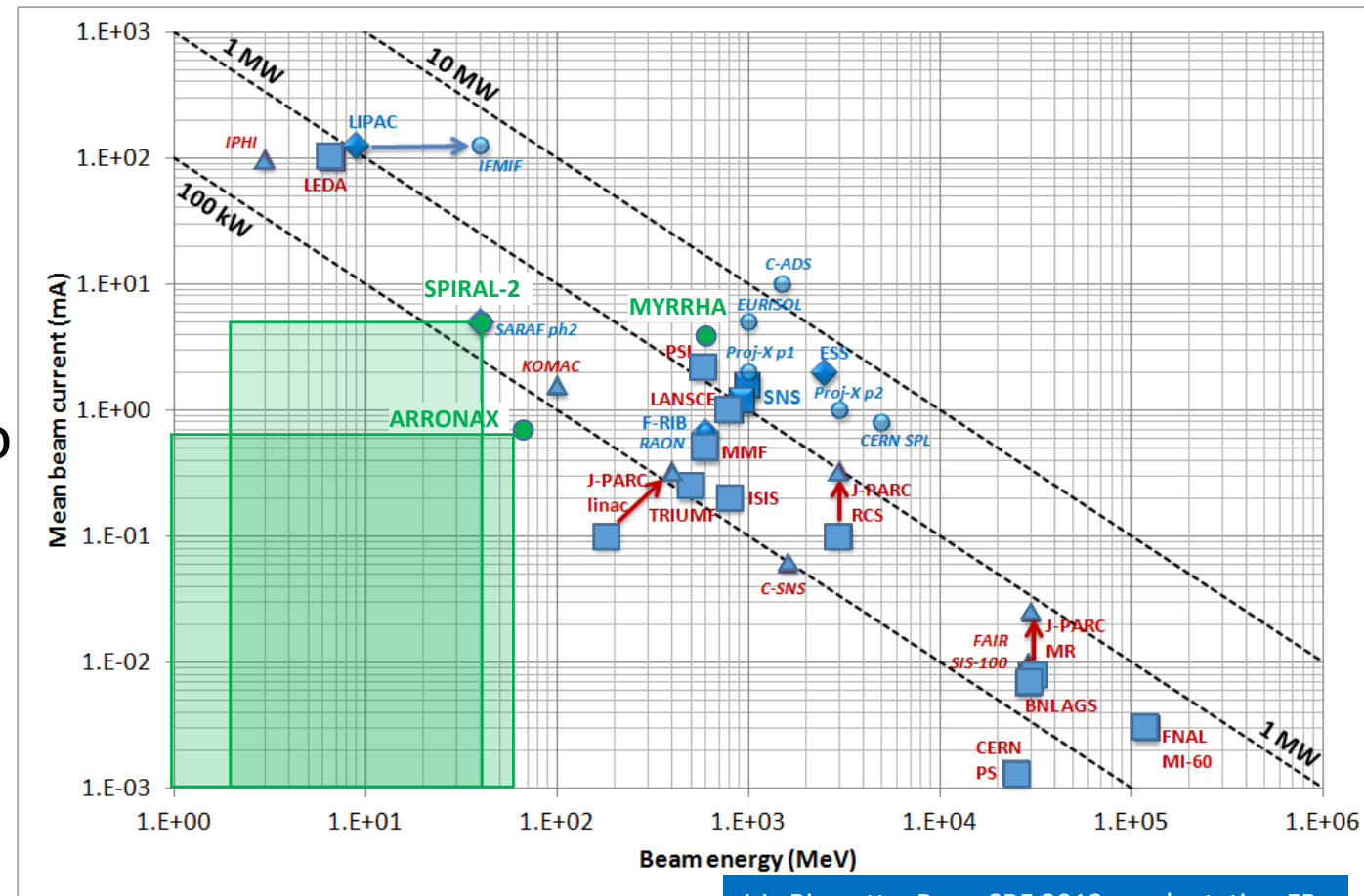

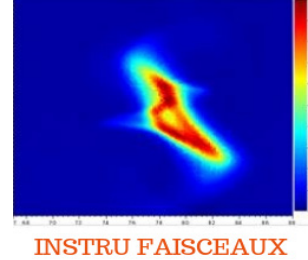

Accelerators

- Experts of the network are involved in a large range of instrumentations,
- For this presentation, We focused on Beam inst. on the following ions machine (not exhaustive):
 - ARRONAX – 10 years of operation
 - SPIRAL2 - commissioning
 - DESIR - project
 - NEWGAIN - project
 - MYRRHA – project (in the paper only)
- Involvement in other ion machine also
 - See emittance-meter part

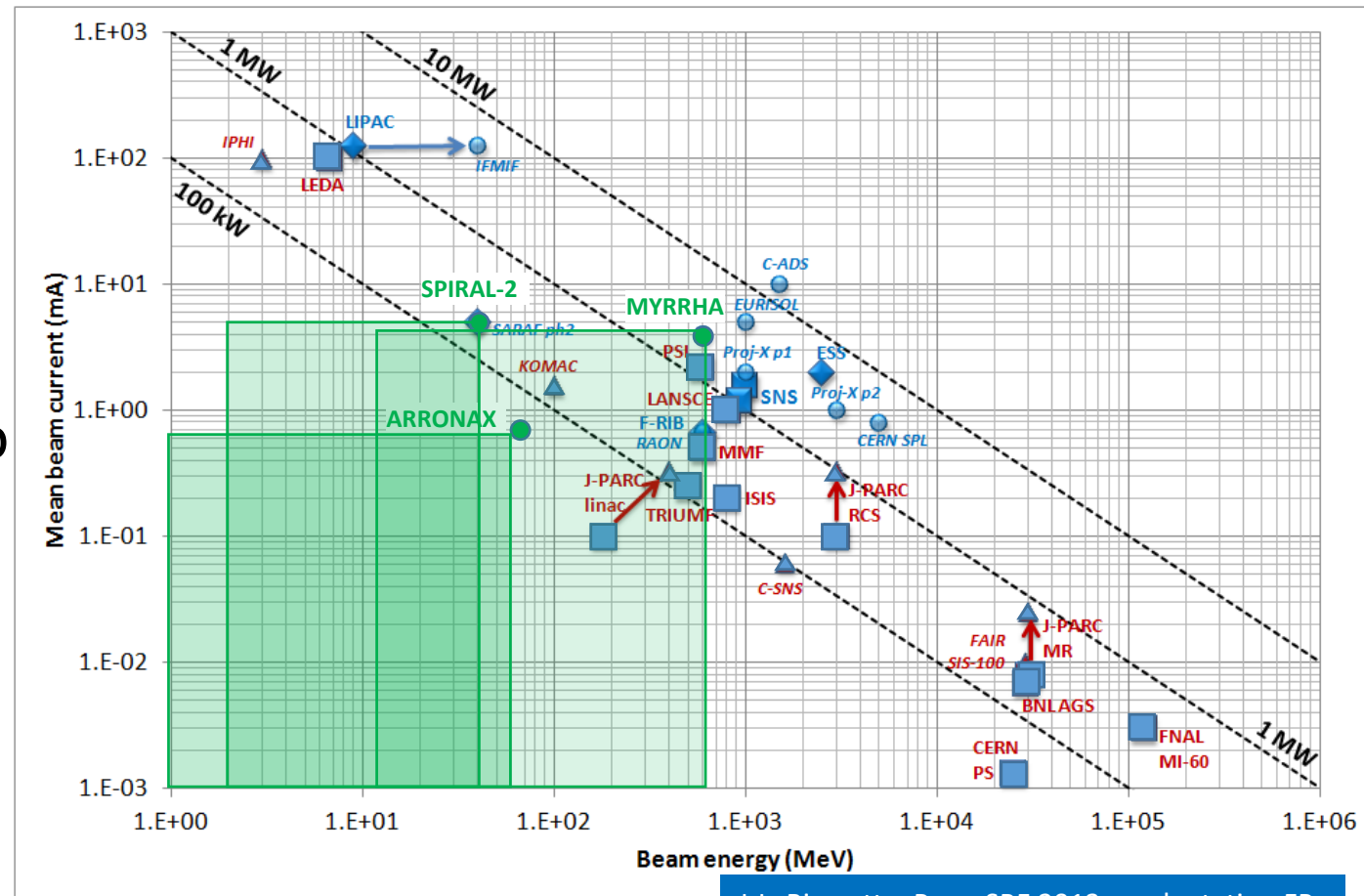

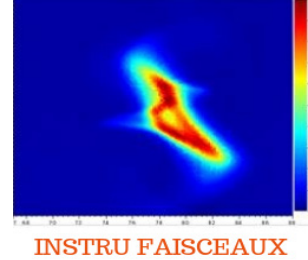

Accelerators

- Experts of the network are involved in a large range of instrumentations,
- For this presentation, We focused on Beam inst. on the following ions machine (not exhaustive):

- ARRONAX – 10 years of operation
- SPIRAL2 - commissioning
 - DESIR - project
 - NEWGAIN - project
- MYRRHA – project (in the paper only)

- Involvement in other ion machine also

- See emittance-meter part

- Rather high power machines
- Operations extend over several order of beam Intensity and over several energy

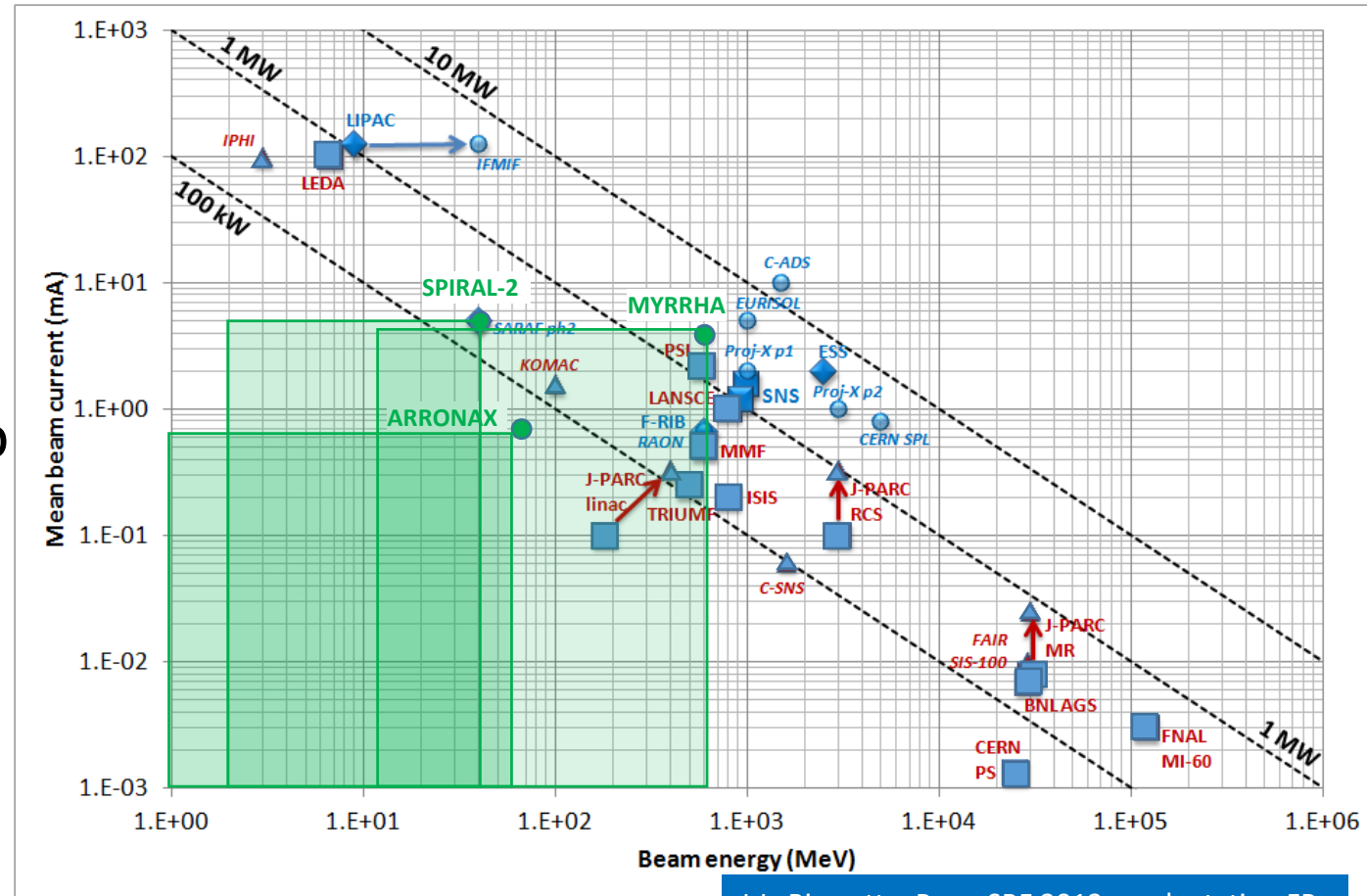

Arronax

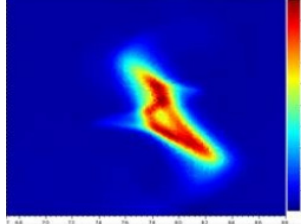

INSTRU FAISCEAUX



- C70XP Cyclotron:
 - Isochron cyclotron with 4 sectors
 - RF: 30.45 MHz
 - Acceleration Voltage: 65 kV
 - Max magn. field : 1.64T
 - 2 sources (ECR, Multicusp)
- 6 main beamlines
- Can provides train of bunches
 - Length ~100us, low to 50 kHz rep.
- 4700h RF eq. time in 2021

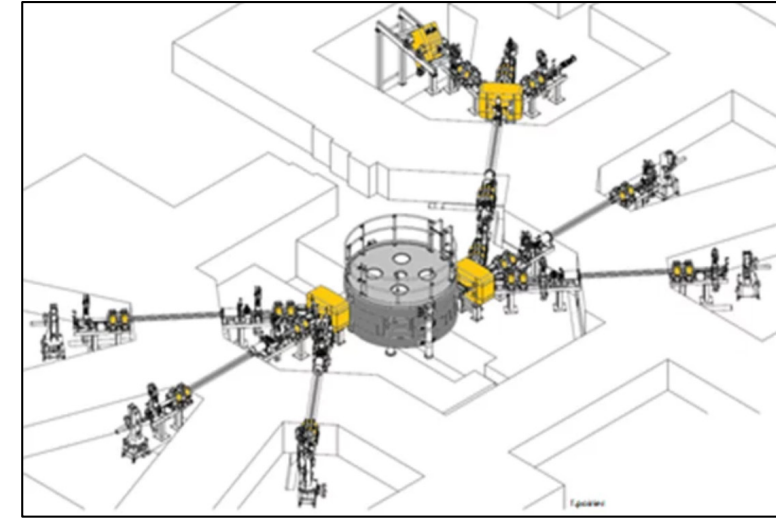

Diagnostics in the beampipes are scarce:

- faraday cups (210kW), BLM, <I> probes (15kW), instrumented collimators
- Planned: injection collimators → See:TUP14, T.Durand, Arronax

Extracted Particles	E(MeV)	<I> (pμA)
H+	30 – 70.3	10 ⁻⁵ , 140 x2 max 750
He2+	67.3	20
HH+	35	0.1 – 1
D+	15 - 35	0.05 – 1.2, 80

• Mainly used for:

- Radio-isotope production (eg ⁸²Sr, ²¹¹At,...)
- Research on Physics, Radiobiology, Radiochemistry
- Studies on Detectors, provide a beam test for diagnostics
- Bench for Flash experiments

A Secondary Electron Ultra-thin Charged Particles Beam Profiler

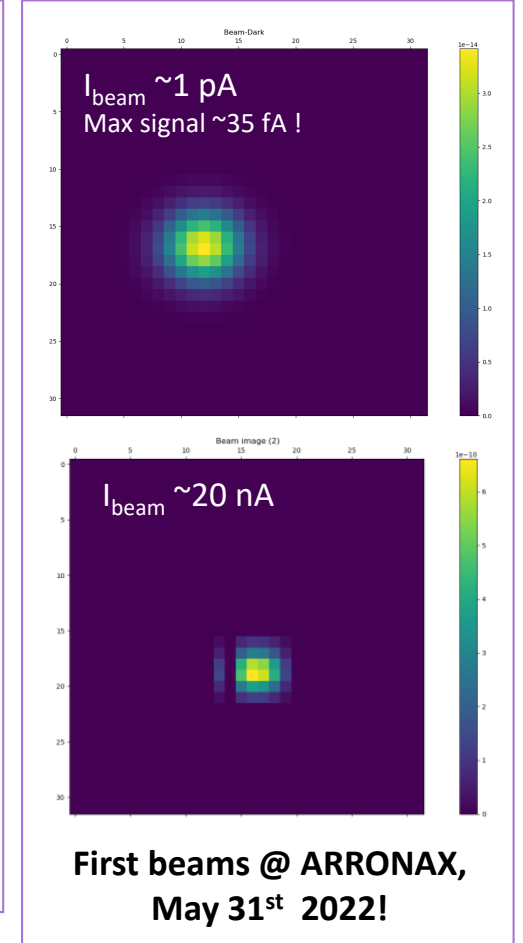
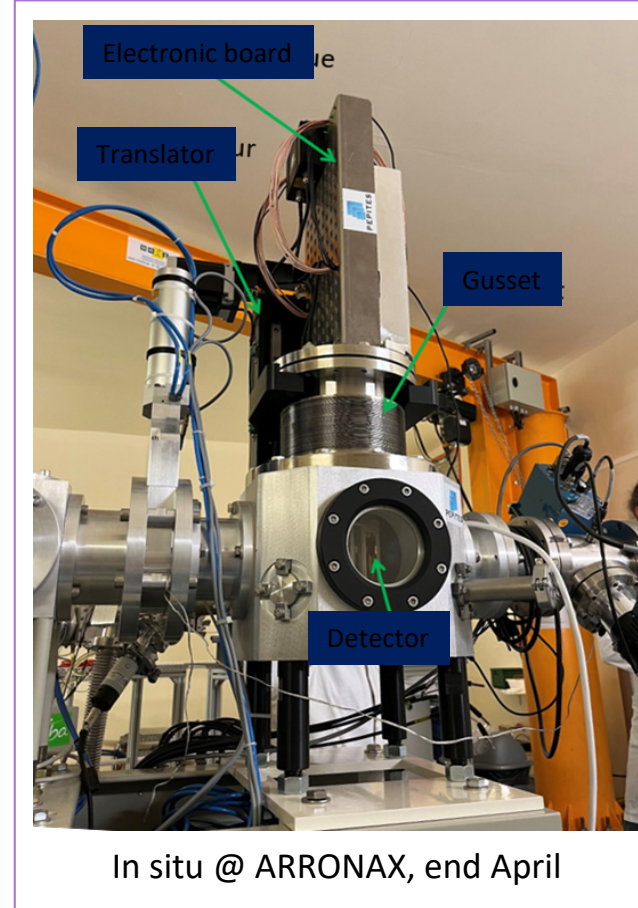
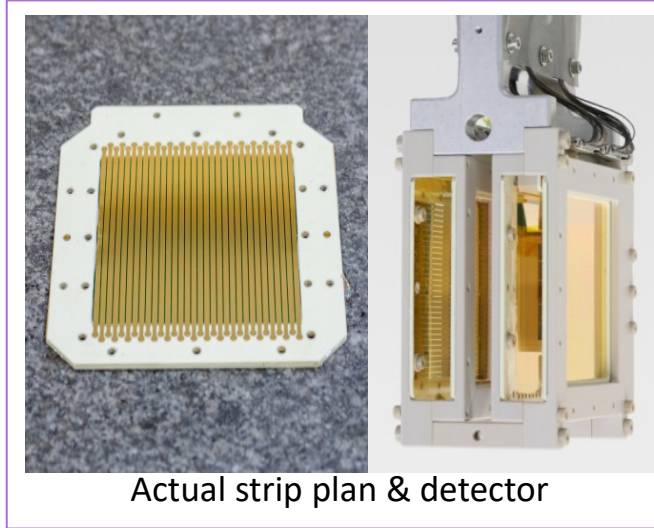
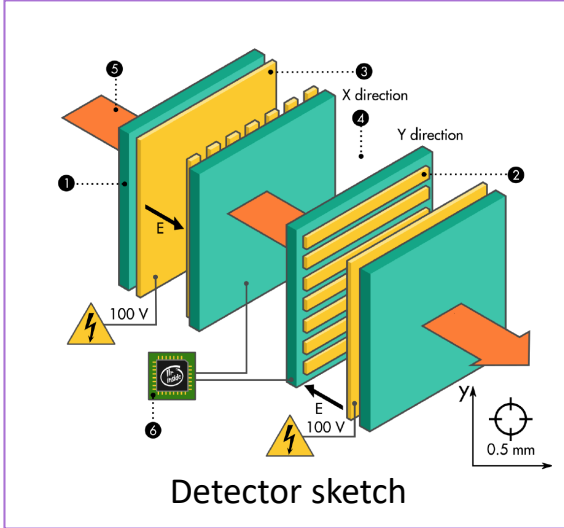
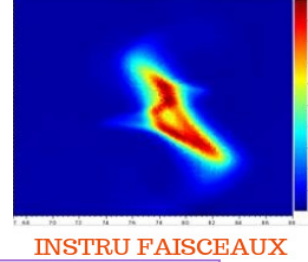

- Secondary Electron Emission based ultra-thin charged beam profiler
 - **10 μm Water Equivalent Thickness**
- Operated in vacuum of beam line
- Built with thin film techniques:
 - Segmented electrode signal : 32 gold strips, **50 nm thick**, ~ 2 mm wide, 7 cm long, deposited on 1.5 μm polyimide film
 - Fully metallized plan for electron collection : same materials and thicknesses, +100 V potential
- Radiation hardness tested
 - @ ARRONAX with 68 MeV protons, up to 10^8 Gy
 - @ LSI with 2 MeV electrons, up to 10^9 Gy
- Low noise and wide range dedicated electronic made by CEA

- **Excellent first results !**
- Future ? CNAO interested ! Designed for continuous currents, but strong assets for FLASH beams !



Diamond as beam tagging monitors

Contact person on diag: M.L. Gallin-Martel, LPSC

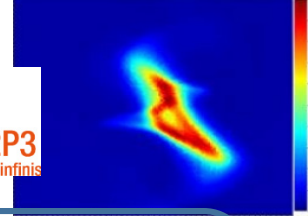

Solid-state ionizing chamber

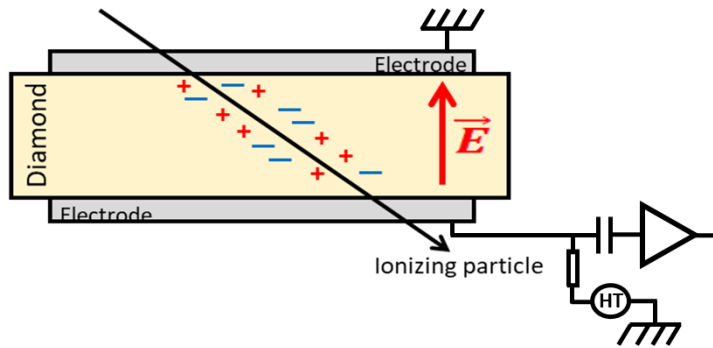

Diamond properties useful for particle detection:

- Radiation hardness
- High mobilities of charge carriers
- High breakdown voltage
- Low leakage current
- Intrinsic efficiency ...

Diamond beam monitor for hadrontherapy

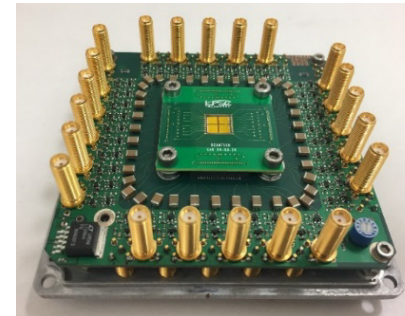
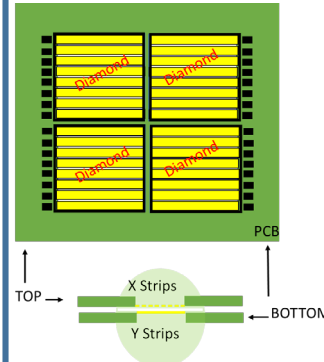

4 sCVD = 1cm²
32 channels

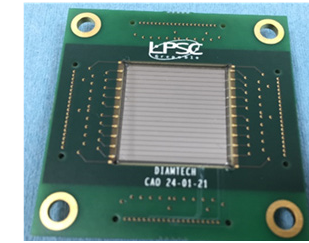

1 pcVD = 4cm²
40 channels

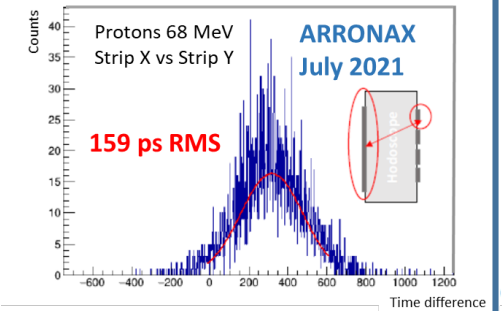

Time resolution (achieved)

LPSC Hodoscope prototype 42 channels + Front End electronic (fast preamplifiers) developed at LPSC

Beams specifications

- **Proton therapy (Cyclotron IBA/C230 Orsay, Dresden...):**
 - ❑ Bunch: 1-2 ns
 - ❑ HF : 100 MHz
 - ❑ 200 protons/bunch
- **Proton therapy (Synchro-cyclotron Nice S2C2):**
 - ❑ Bunch: 7 ns (16 ns)
 - ❑ Train: 4 μs (1 ms)
 - ❑ 10⁴ protons/ micro-bunch
- **Carbone therapy (HIT/CNAO):**
 - ❑ Bunch: 20-40 ns
 - ❑ Bunch interval: 200 ns
 - ❑ 10 ions/bunch

Beam tagging hodoscope specifications

- **Counting rate:**
 - ❑ 100 MHz for the whole detector
 - ❑ ~10 MHz per channel
- **Time resolution:**
 - ❑ **At the level of 100 ps**
- **Spatial resolution:**
 - ❑ **1mm (readout strip)**
- **Radiation hardness:**
 - ❑ 10¹¹ protons/cm²/treatment, about 20 treatments a day =>10¹⁴ protons/cm²/year

Diamond as beam tagging monitors

Contact person on diag: M.A. Laure-Gallin

ANR - DIAMMONI Project (2020-2024)

Objective: diamond monitor aimed to count in bunches at low proton beam intensity, and in trains at high intensity

=> dedicated to equip a beam line at the ARRONAX Cyclotron.

Two operating modes: bunch and train counting

- **Bunch counting mode :** from a single particle up to 100 protons per bunch (4ns ON, 29ns OFF). At this intensity, dedicated preamplifier are required (*electronic development in progress at LPSC*)

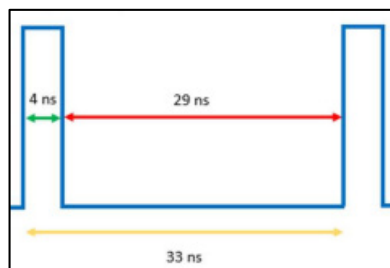
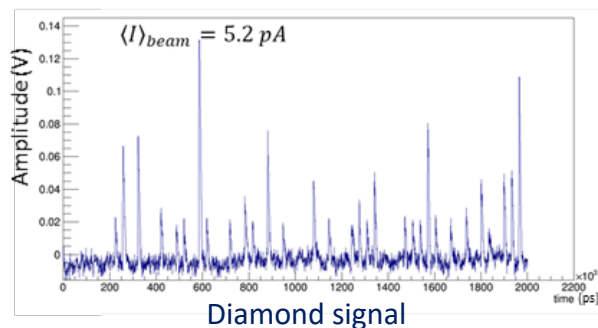

ARRONAX beam structure

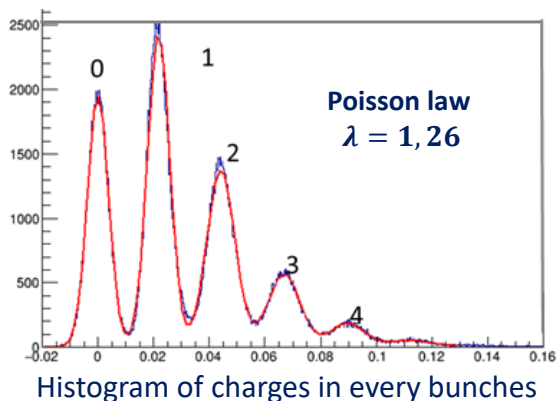

Availability to time stamp each single bunch with a time resolution of:

- 100ps in a single particle regime
- ~1ns for tens of particles in a bunch



- **Train counting mode :** at higher intensity, diamond is directly connected to acquisition system. 5 μ A has been reached recently at ARRONAX. Electronic developed at LPSC already validated => **FLASH therapy for medical application**

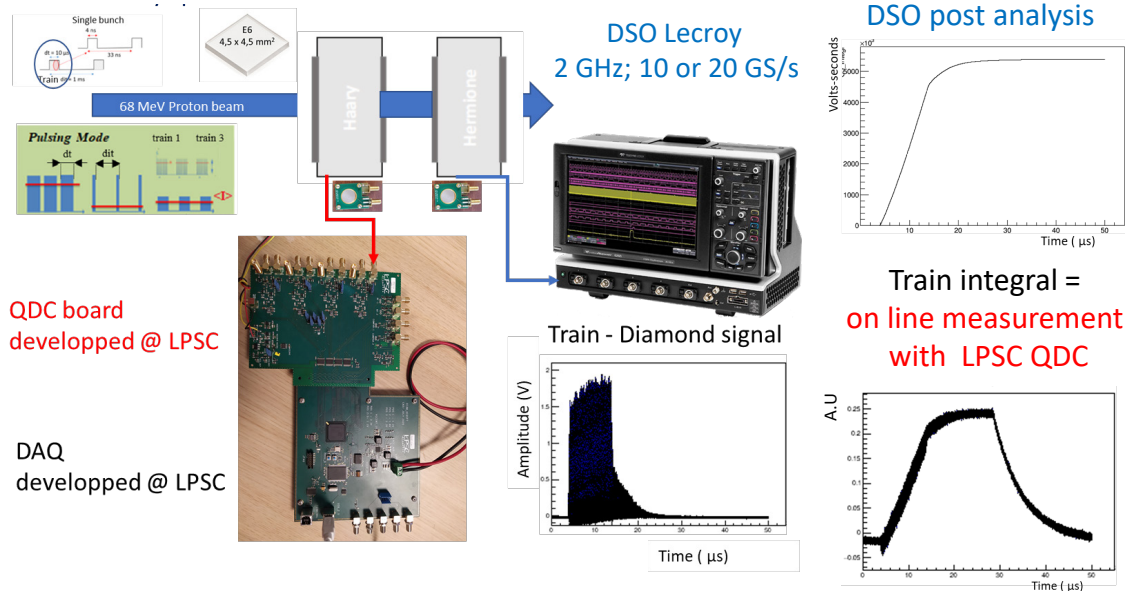

5 μ A on Diamond reached in May 2022 ~10⁶ protons within 4 ns @ 30,45 MHz

Train « Start » and « Stop » stamped

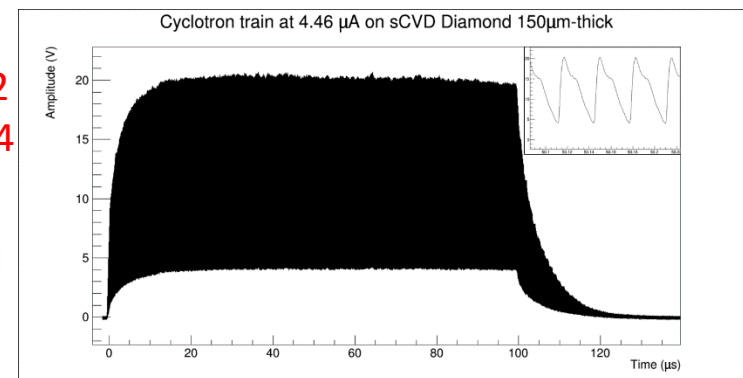

Spiral2 , DESIR and NEWGAIN at GANIL

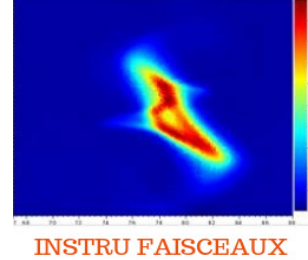

INSTRU FAISCEAUX

See WE211, from H. Franberg Delahaye, "SPIRAL2 commissioning", GANIL

Supported by  **anr**®
agence nationale
de la recherche

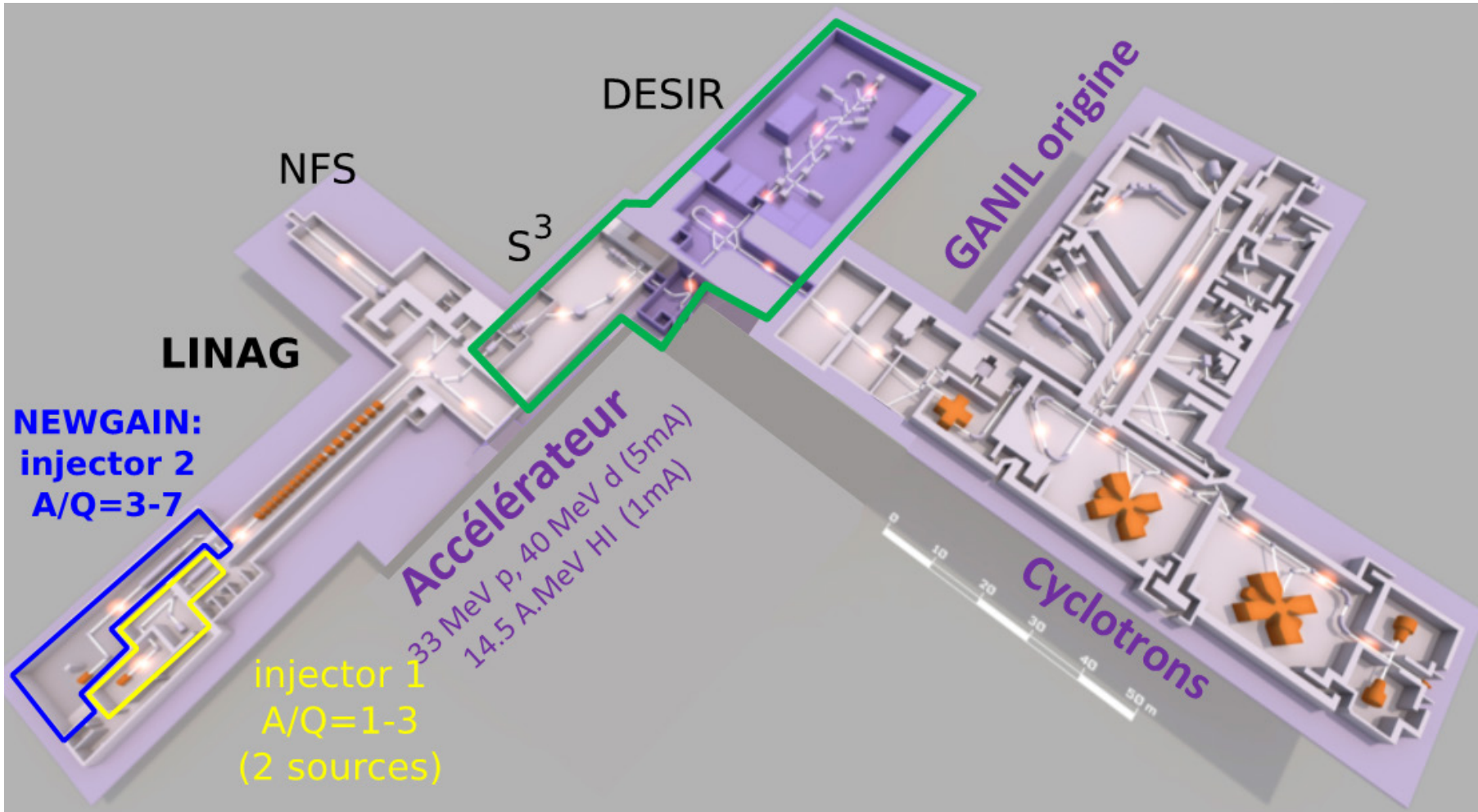

SPIRAL2:

- 5 mA p-d ion source
- 1 mA heavy ions source ($A/Q \leq 3$)
- CW RFQ and a SC linac

Spiral 2 – Diag POV commissioning

Contact person on diag: C.Jamet, GANIL

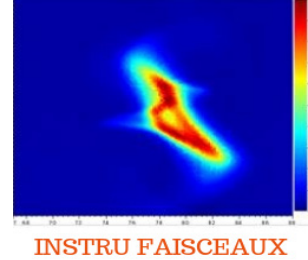

- From December 2015 to November 2018, First commissioning phase.
 - RFQ beams and Diags were characterized with a Diagnostic Plate (removed since)
- In July 2019, the beam commissioning with a proton beam started in the MEBT. Then, from October to December, the commissioning continued in the linac and HEBT.
- In July 2021, with a helium beam at 40 MeV, beam energies were measured using ToF with BPMs

Diagnostic Plate

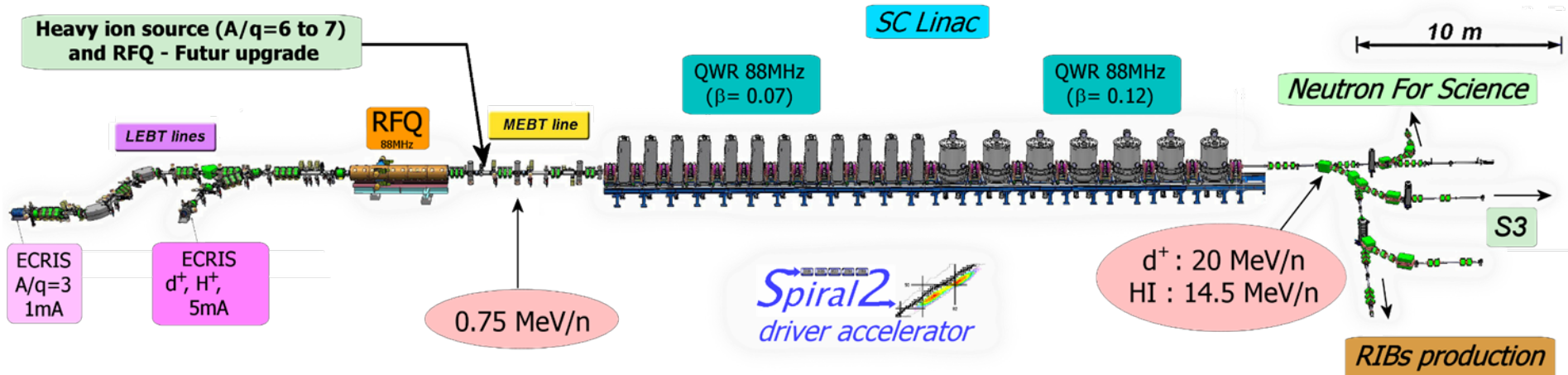
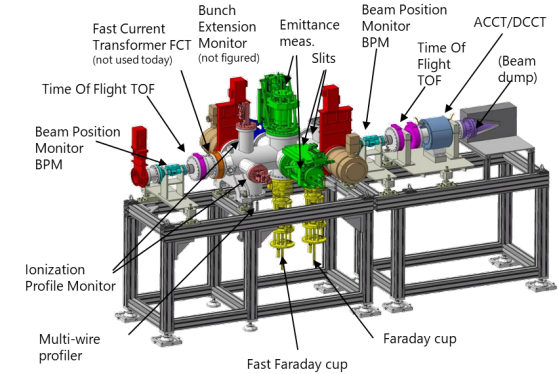



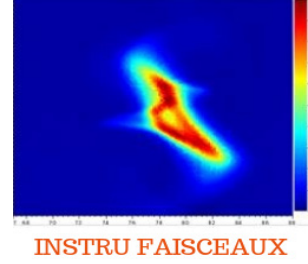



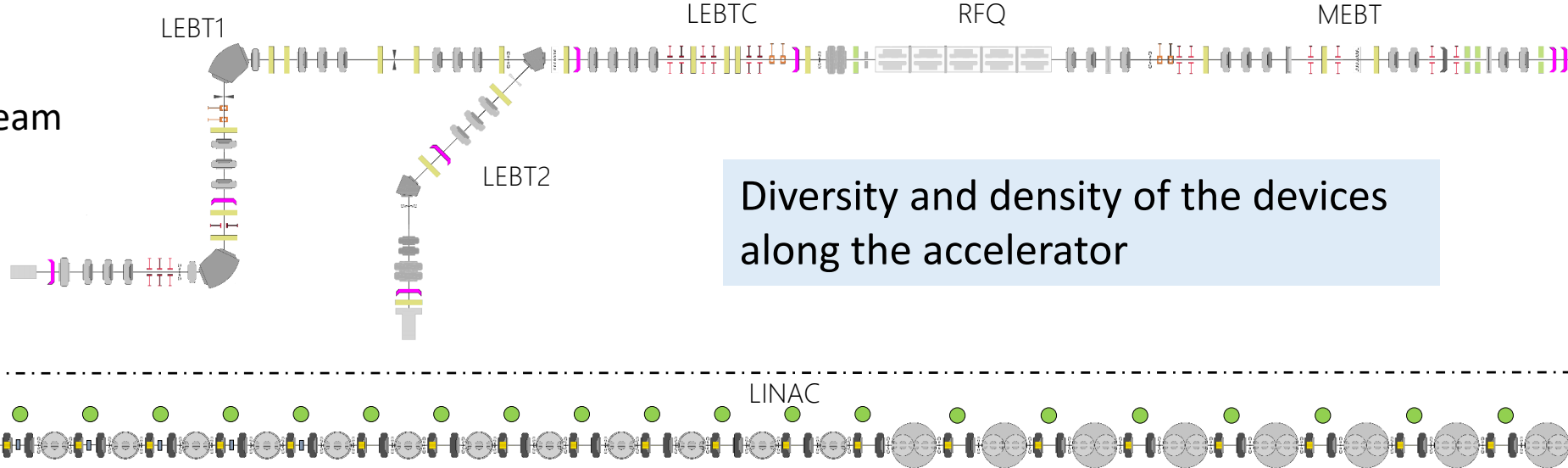





SPIRAL2 Diagnostics



Low Energy Beam Transfer



Diversity and density of the devices along the accelerator

-  6x Faraday Cup (FC)
-  1x Fast Faraday Cup (FFC)
-  16x Pair of slits
-  6x Loss Ring
-  1x Segmented Collimator
-  4x DC Current Transformer (DCCT)
-  3x AC Current Transformer (ACCT)
-  23x Multi-wire Profiler
-  6x Emittance meter
-  5x Bunch Extension Monitor (BEM)
-  1x Time Of Flight (TOF)
-  20x Beam Position Monitor (BPM)
-  32x Beam Loss Monitor

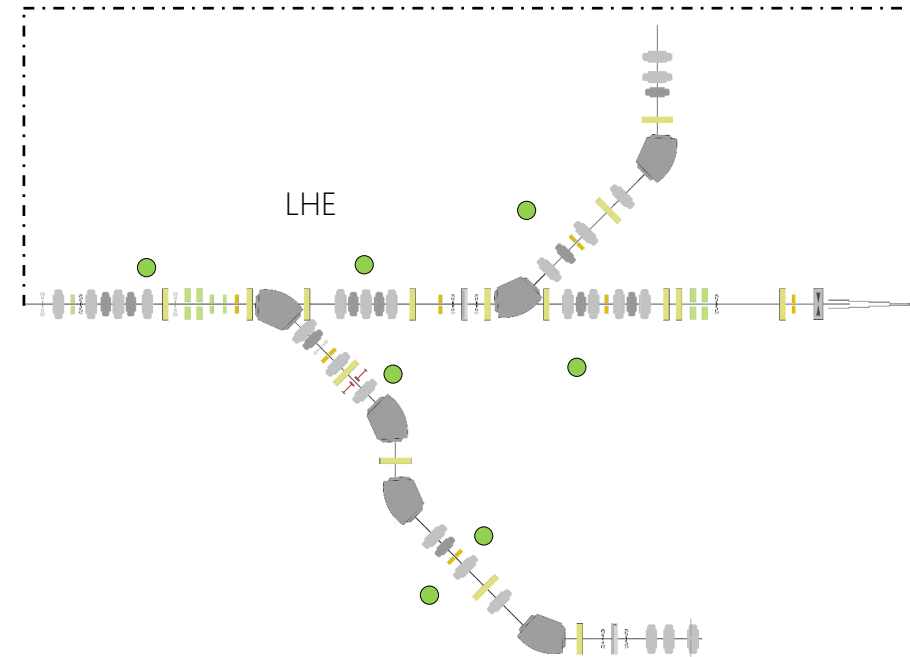

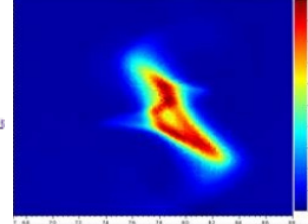

INSTRU FAISCEAUX

BEAM POSITION MONITORS (BPM)

Principle: Bunch electric field generates RF signals on electrodes. Amplitudes and phases of fundamental ($h_1 = 88$ MHz) and second harmonic ($h_2 = 176$ MHz) are used to calculate position, ellipticity and phase.

20 BPMs are installed in the warm sections of the linac.

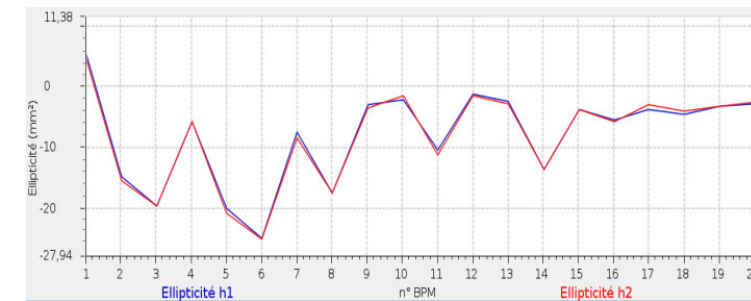
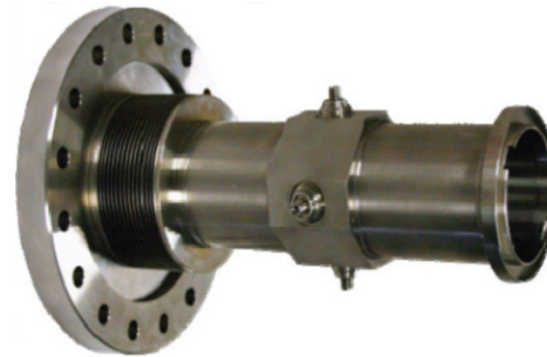
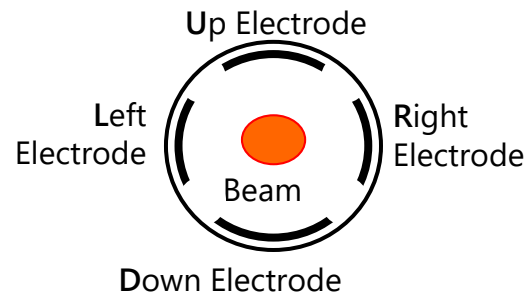

$$Position X_{h_1} = K_{h_1} \times \frac{R_{h_1} - L_{h_1}}{R_{h_1} + L_{h_1} + U_{h_1} + D_{h_1}}$$

$$Position Y_{h_1} = K_{h_1} \times \frac{U_{h_1} - D_{h_1}}{R_{h_1} + L_{h_1} + U_{h_1} + D_{h_1}}$$

$$Ellipticity h_1 = S_{h_1} \times \frac{R_{h_1} + L_{h_1} - U_{h_1} - D_{h_1}}{R_{h_1} + L_{h_1} + U_{h_1} + D_{h_1}} - (X_{h_1}^2 - Y_{h_1}^2)$$

$$Phase h_1 = atang \left(\frac{Q(\vec{R}_{h_1} + \vec{L}_{h_1} + \vec{U}_{h_1} + \vec{D}_{h_1})}{I(\vec{R}_{h_1} + \vec{L}_{h_1} + \vec{U}_{h_1} + \vec{D}_{h_1})} \right)$$

Limitations :

Intensity min ~ 50 μ A

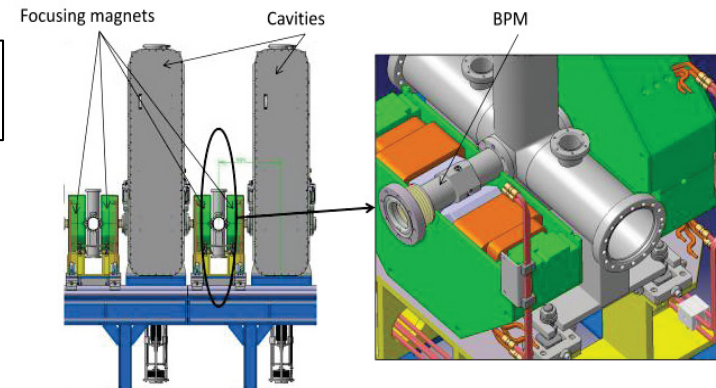

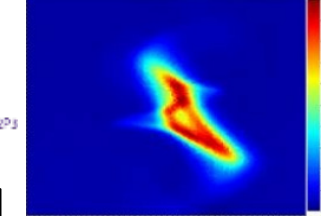

INSTRU FAISCEAUX

Velocity comparisons between TOF and BPMs with a proton beam of 3 MeV.

The new procedure, to tune the linac cavities, use the beam velocity from BPMs, which implies measuring the BPM phases with the same reference.

The beta velocities between BPM and TOF are close, with a maximum difference of 0,2 %.

These results are obtained thanks to BPM electronics (collaboration with the Indian laboratory BARC)

Main corrective actions taken during the commissioning phase:

- EMC modifications to decrease the disturbances from the RF cavities
- Reinforced shielding cables & RF-shielded electronic cabinet
- 50 Ohm matching of the 20*4 BPM electrodes
- New precise calibration of the 22 modules

Now: automation of the calibrations and an increase of the sensitivity towards the very low levels

Next Modifications:

- Cable phase corrections
- Position and ellipticity monitoring connected to the T-MPS
- Stop Acquisition management and Post-Mortem Data optimizations
- Offset deductions for low intensities measurements
- Automatic gain tuning
- Code optimizations
- Spare module reception and qualification
- GUI modifications

Beam Transmission Monitors

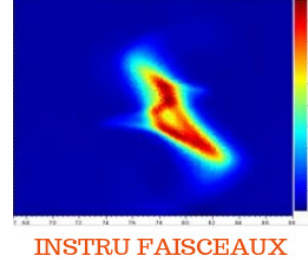

INSTRU FAISCEAUX

BEAM TRANSMISSION WITH ACCT OR DCCT

Principle: Intensity difference between two ACCT or DCCT.

Used to tune and survey the beam losses

Tuning with ACCT

Same Graphical Interface as intensities

Full scale range	10 mA
P-P noise (BW 1Hz)	~16 μ A
Gain error	~0.6 %
Gain difference between 2 ACCT	~0.1 %

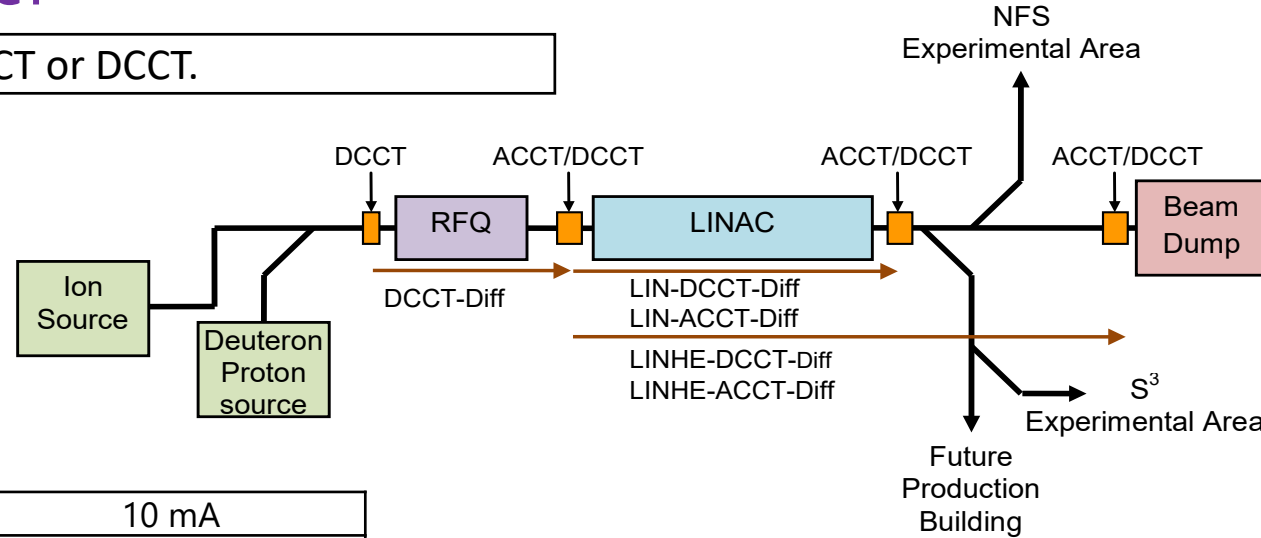

Categorised as part of EPS: Safety Probability Evaluation

Monitoring of the difference average

DCCT : Enlarged Machine Protection System (E-MPS) to limit radiations produced by beam losses

⇒ Monitoring of 250 μ A beam loss (159 μ A including uncertainties margins)

ACCT : Thermal Machine Protection System (T-MPS) , to protect the machine

⇒ Monitoring of around 1 μ A ideally, and as low as possible in real life

Next Steps: EMC optimization to decrease the noise of ACCT chains.



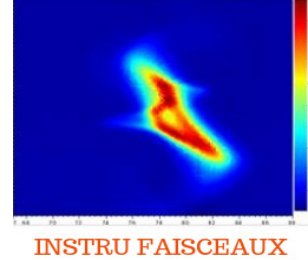

SPIRAL2 LINAC

Dedicated to the study of nuclear structure, astrophysics, and weak interaction at low energy

Exotic ion beams (RIB)
= SAMPLES to measure

Contact person: L.Daudin, LP2I

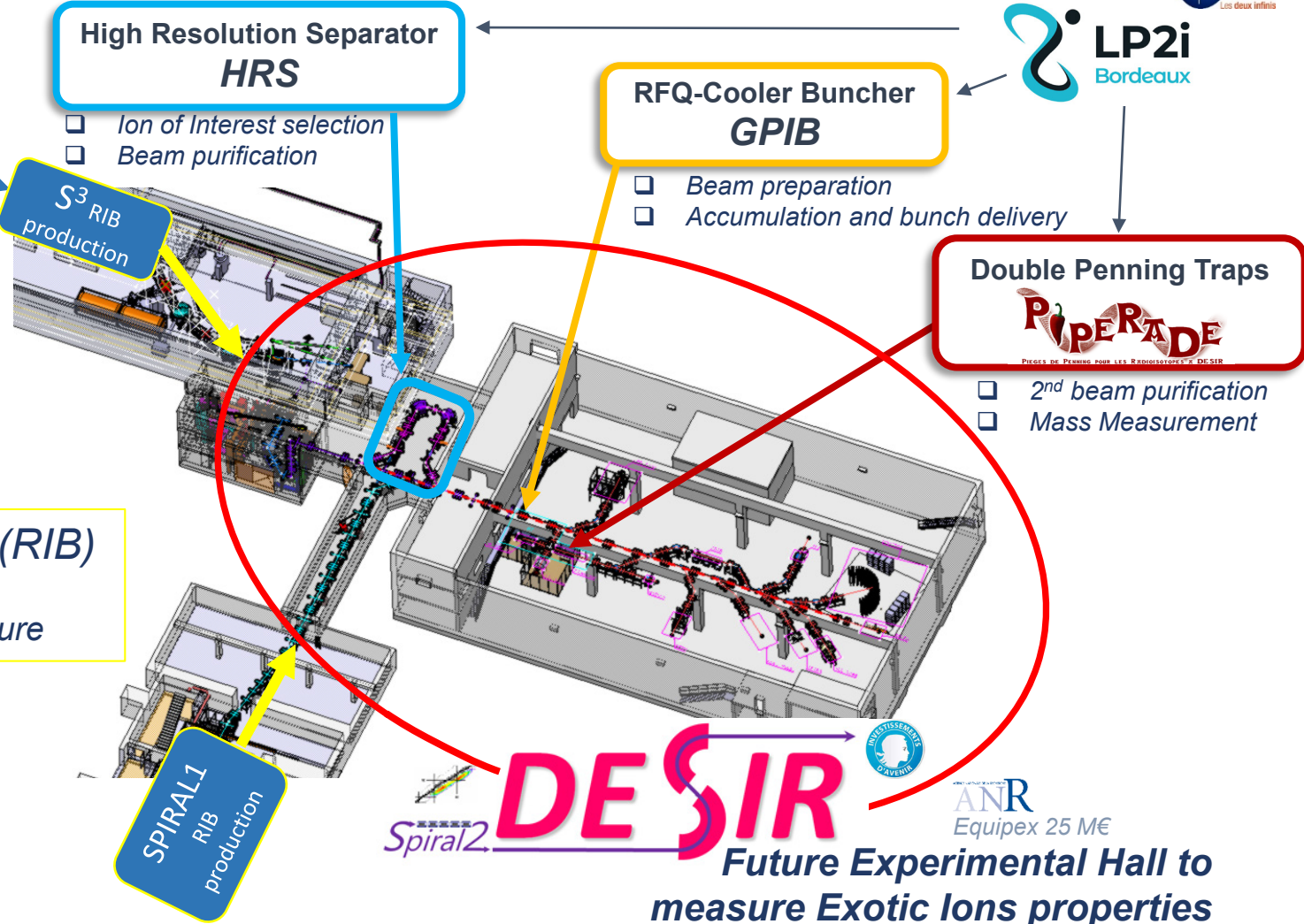

- Low energy ions (< 60 keV)
- Low intensity beam (< 10⁸ pps) CW & Bunched

DESIR ANR Equipex 25 M€
Future Experimental Hall to measure Exotic Ions properties

- Laser Spectroscopy
- Mass Spectroscopy
- Decay Spectroscopy

- ☐ Low energy (< 60 keV)
- ☐ Low intensity (< 10^8 pps) CW & Bunched

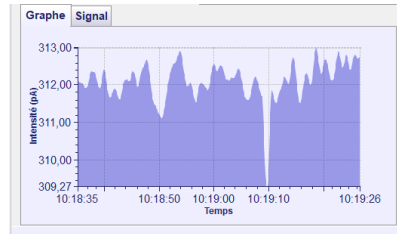
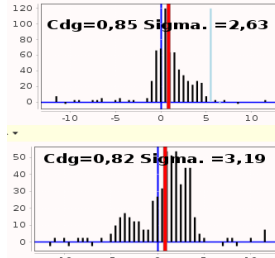
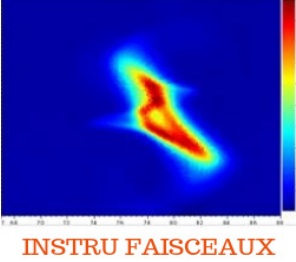

EPICS
Control System

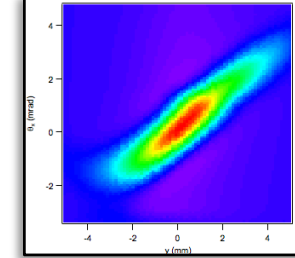
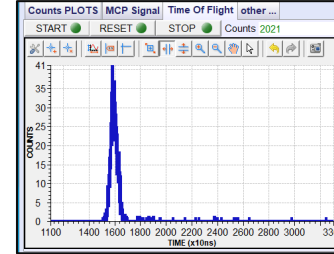

BPM

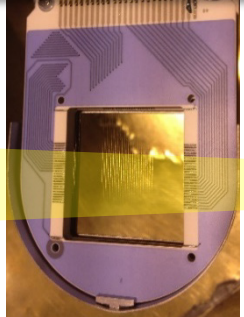

✓ GANIL Profilers

Wire Harps

- 2 x 47 W/Au wires (H & V)
 - 70 μ m diam.
 - 0,5 mm step
- Semi-interceptive 90% transp.
- 1 ms < IT < 10 second
- Ceramic PCB

FCup



✓ GANIL SPIRAL2 FCup

CW beam :
GANIL-PicoLin IV Amplifier



- High sensitivity / Low Bandwidth
- **Wide range (50 fA ... 10 μ A)**

microsecond bunches:
Femto DHPCA IV converter



- High Bandwidth / Less sensible
- > 5 nA \rightarrow 3. 10^4 ions / 1 μ s bunch

MCP

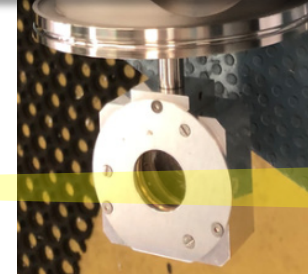

✓ LP2i Bordeaux

TOPAG
MicroChannelPlates

- Counting Mode
- **Single ion to 10^7 pps**
- Attenuation grids for higher intensity & Energy Meas.

LP2iB RedpiTOF



- Redpitaya board FPGA dev.
- Counting (upto 5. 10^7 pps)
- Time Of Flight (10 ns resolution)

EMT

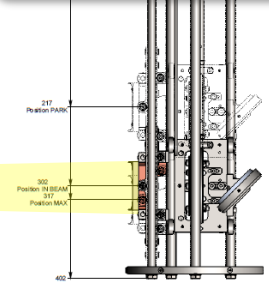

✓ Pantechnik

« PepperPot » type

- Emit. Figure Shape measurement to estimate and correct HRS aberrations.
- \rightarrow resolving power improved

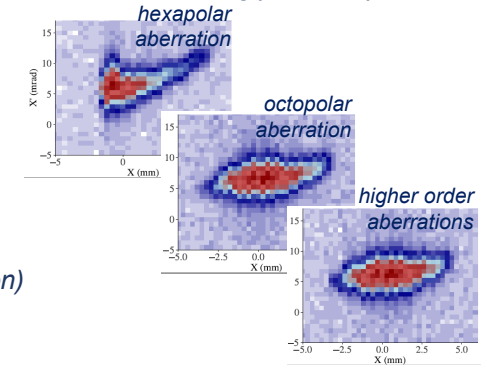

Diagnostics for NEW GANIL Injector

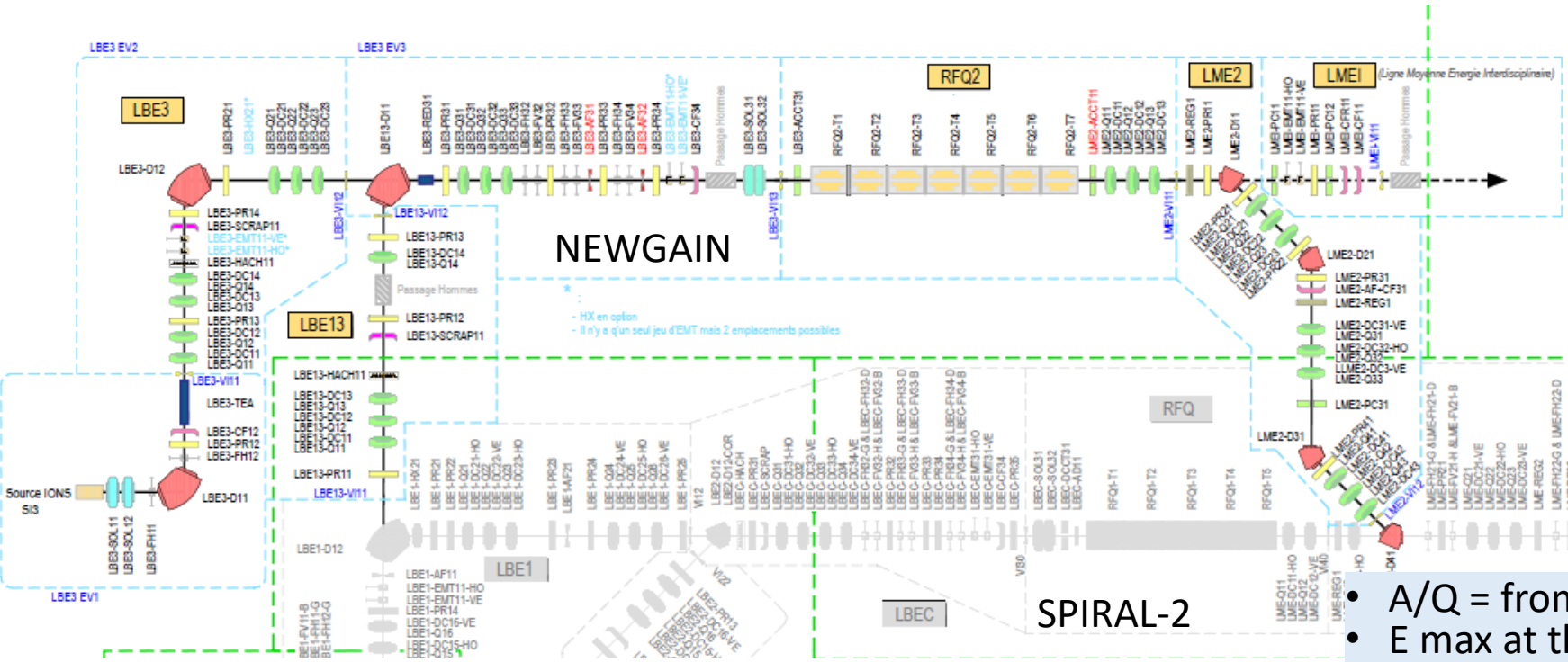
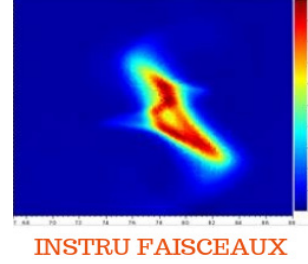

- LME2 :**
- 1 ACCT in flange (under study)
 - 1 FC/Beam Dump
 - 6 EMS PR
 - 1 AF

- BRI :**
- 1 Emittancemeter H et V Allison Type
 - 1 EMS PR
 - 1 Phase probe
 - 1 FC
 - 1 FFC

- LBE3 :**
- 1 chopper + Scraper 100 kHz (under study)
 - 2 FC
 - 8 EMS PR
 - 1 Emittancemeter H et V Allison Type
 - 1 ACCT in flange (under study)
 - 1 Pepper Pot (TBC)
 - 2 Beam Dumps
 - 2 slits H
 - 6 slits (3H et 3 V)

- LBE13 :**
- 1 chopper + Scraper 100 kHz (under study)
 - 1 EMS PR

- A/Q = from 3 to 7 (optimized for 7)
- E max at the end of LINAC: 7 MeV/A
- 10 keV/A pour LEBT, 590 keV/A LEMT
- I max : 6 pμA for U, up to 10 pμA for others.
- Frequency from 1 Hz (@0,5 s) to 100 kHz (@ 1 μs)
- Large amount of dedicated diagnostics:
 - No new development excepted for ACCT and Chopper (C.Jamet GANIL)
 - Others diagnostics reused from Spiral 2 development

Contact person: C.Peaucelle, LPSC

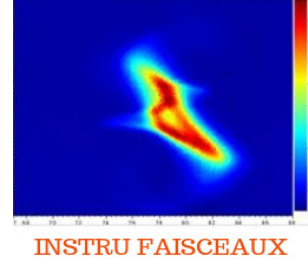

Experimental setup and beam characteristics

Contact person on diag:
C.Koumeir,
Arronax

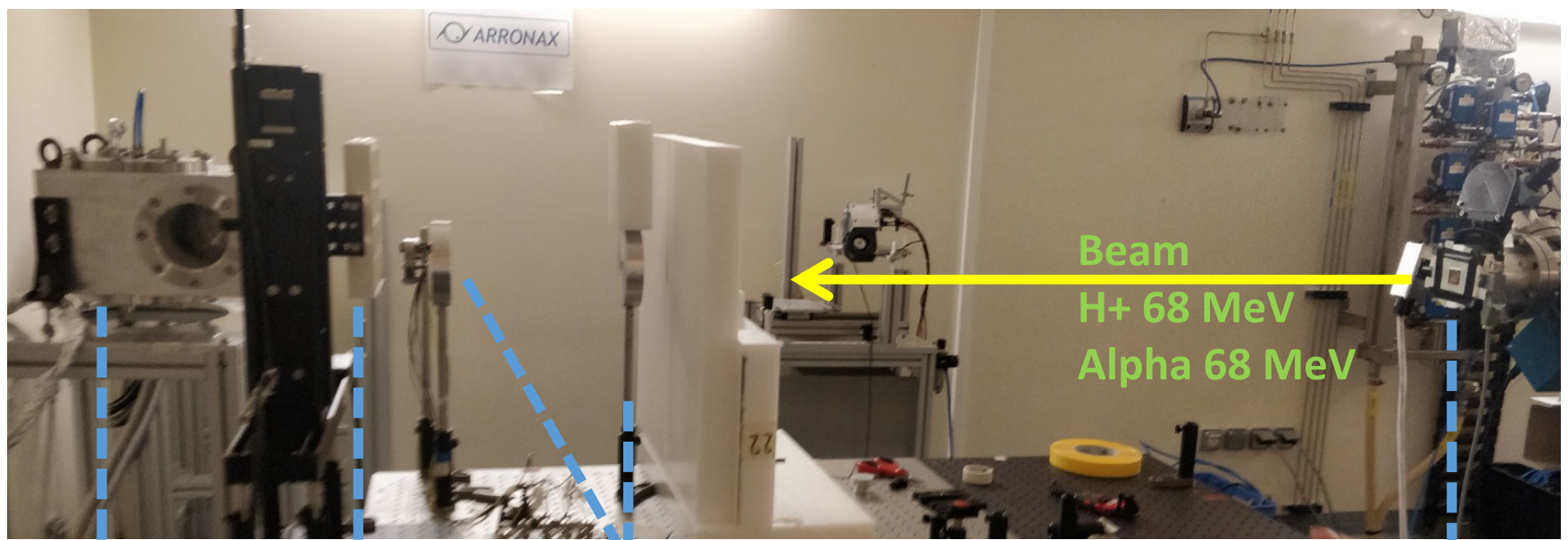

Faraday Cup

Target holder (X,Y)

Collimators: 10 mm (left)
15 mm (right)

Kapton exit window
+système de refroidissement
+Photomultiplier

Performance of gafchromic films:
EBT3, EBT-XD,
OC-1.

Pulsing system installed in the injection part to modify the beam structures:

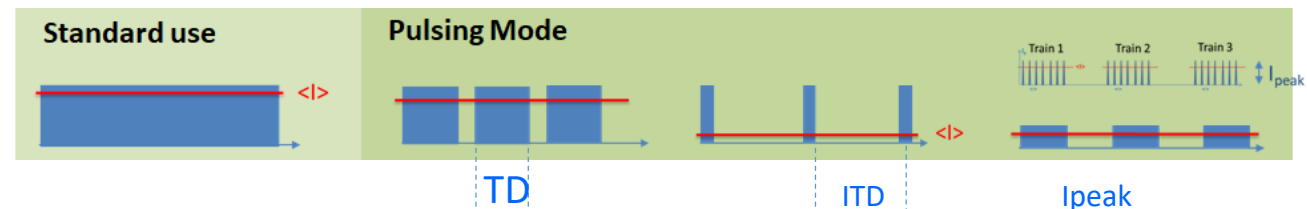

Parameters "we play with"

Train duration (TD): $>1\mu s$
Inter-Train Duration (DIT): $>20\mu s$
 $\langle I_{beam} \rangle$ up to $20\mu A$

Instantaneous dose rate:

Up to $300kGy/sec$ (beam spot
10mm diameter)

Zebrafish embryos

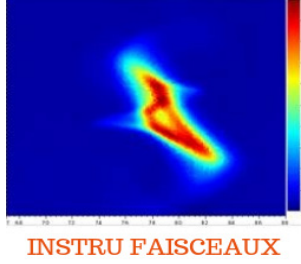

Beam monitoring for Flash irradiation @Arronax

Contact persons on diag: C.Koumeir, Arronax

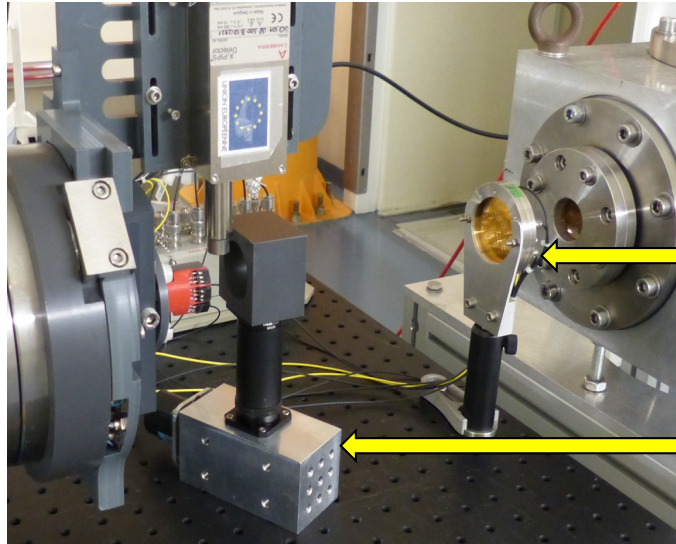

Faraday Cup (golden reference)

Ionisation chamber for conventional dose rate

Photomultiplier detect the UV photons of the excited nitrogen molecules for Flash irradiation

Trigger of the pulsing system

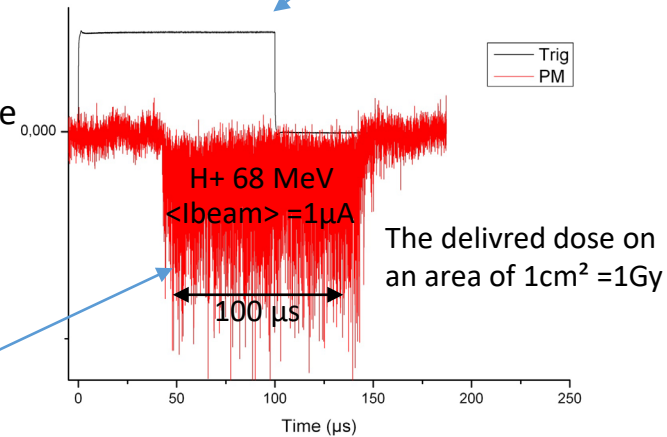

➤ The variation of the PM response compared to the Faraday cup is less than 2% for a wide range of the dose rate up to 300kGy/sec.

➤ A new prototype to allow beam position as well as dose, dose-rate and time monitoring during patient treatment at ultra-high dose rates is under development in collaboration with IBA

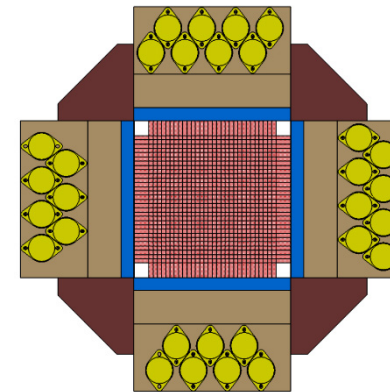

Emittance-meter

Contact persons on diag: F.Osswald, IPHC

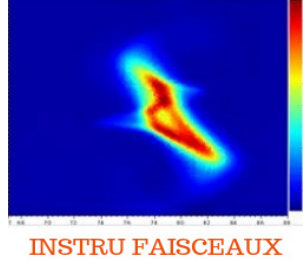

- 2D Emittance measurement of low energy ion-beam
 - Allison principle with double slit and deflection (Los Alamos, 1983)
 - Revisited by IPHC in 2008 and new prototype in 2020
- Scan of charge distribution in position and angle
 - 100 μm and 1 mrad resolution
 - ± 100 mrad acceptance
 - 1-100 mm beam diameter/1-100 pi mm.mrad
 - 100pA-3 mA beam intensity
 - 300 W, 1 kW/cm² beam power
 - DC or pulsed (1 MHz)



Emittance-meter

Contact persons on diag: F.Osswald IPHC

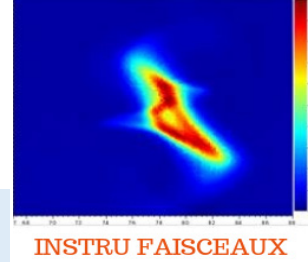

- Emittance meter in operation on different facilities since 2021.
- Now shared in the framework of the French Beam instrumentation network
- Planned to be used/adapted on the above accelerators (Newgain, Myrrha,...)

- Goal:
 - Share equipment
 - Discuss, analyse measurements
 - Improve collective knowledge
- Issues raised:
 - Versatility for various applications
 - Availability
 - Radioprotection & transport
 - Safety procedure

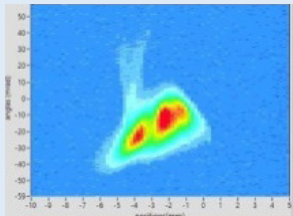

ARRONAX, Nantes:
cyclotron injection channel.
Multibody structure with
non-uniform charge density

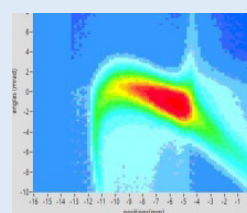

IPHC, Strasbourg: EmitM
commissioning on ion source
test bench (HeatWave Labs, Inc)

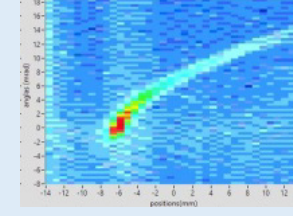

L2IB, Bordeaux: DESIR/SPIRAL 2
spectrometer
on line characterization

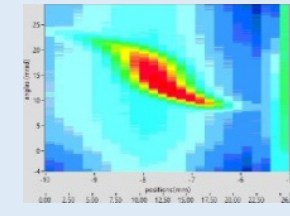

ARIBE: characterization of Ar⁸⁺ beam
at 30 keV
and commissioning of beam focusing
prototype

Additive manufacturing to design advanced diagnostics

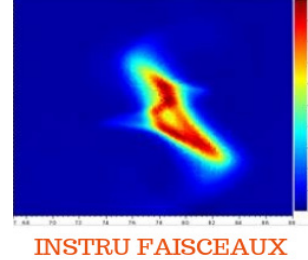

- We are investigating the use of additive manufacturing for diagnostics.
- It allows design closer to physical requirements.
- Eg: on a BPM, the electrodes can have a better impedance matching.
 - 60% of original weight
 - Shorter production time

N.Delerue - IJCLab

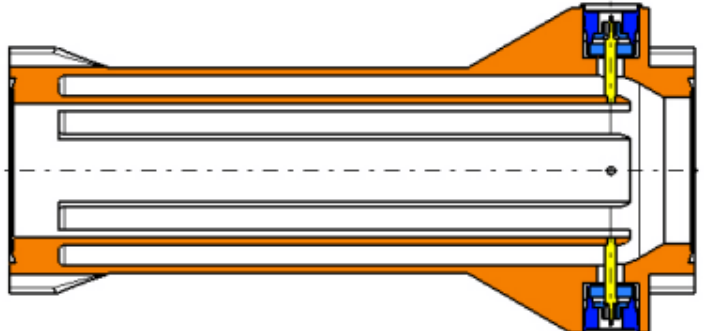

stress induced displacement

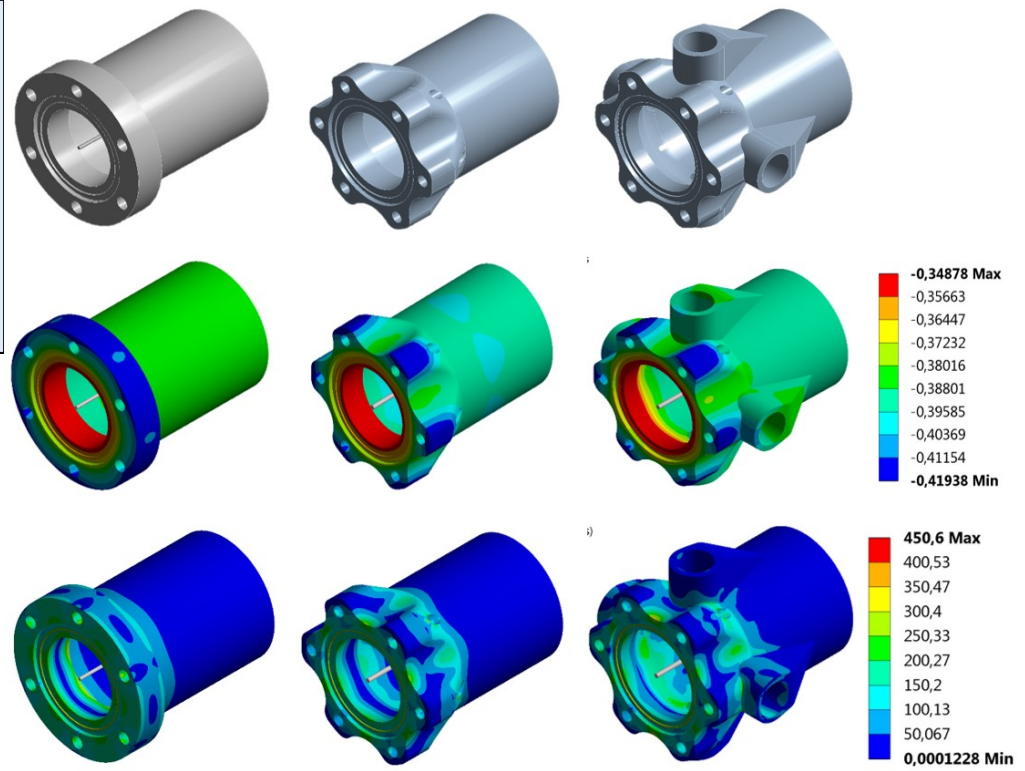

See also: T. Torims presentation at HIAT "3D printing (additive manufacturing) applied to accelerator components", Riga Tech. Univ.

Conclusion

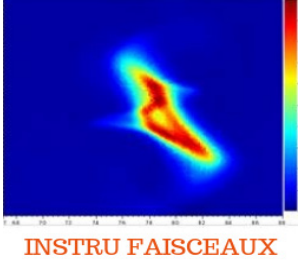

- A few words on beam instrumentations (not representative):
 - has to deal with large dynamic range (I, E, Duty cycle,...):
 - Beam instrumentations are adapting:
 - Diagnostics with an inner large range
 - Several diagnostics put together to cover range
- Network:
 - keeps working efficiently
 - align its work-in-progress with the demands
 - consistent with the recommendations on the IN2P3 2020-30 prospects
recommandations:
 - “prime importance to guarantee a suited scientific and technical support for accelerators development” & “to strengthen the connection between accelerators and detectors community”
 - “particularly R&D activities on beam instrumentation”
 - Work in continuous progress

Acknowledgments

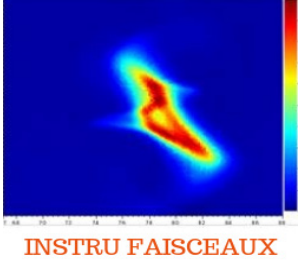

- Thank you for listening and the HIAT organisers!
- Thanks to the IN2P3 management team for initiating and financing this network
- Thanks to all the actors of this network who feed the exchanges and contribute greatly to its life and its improvement