

67th ICFA Advanced Beam Dynamics  
Workshop on Future Light Sources: FLS 2023

# Advanced Electron Beam Diagnostics for FELs

Patrick Krejcik  
SLAC



# Diagnostics requirements for future FELs

## Performance drivers for FELs

## Implications for diagnostics

$$P_{peak} = \rho_{eff} I_{peak} \frac{E}{e} \quad L_g = \frac{\lambda_u}{4\pi\sqrt{3}\rho_{eff}}$$

- Higher beam energy
  - Lower beam emittance
  - Peak current, and bunch length
  - Beam position and FEL alignment precision
  - Undulator peak field and period length
  - High (CW) repetition rate
- 
- Smaller beam sizes
  - Shorter bunch lengths
  - Greater single-shot position resolution (at low charge)
  - Cryogenic RF BPMs for SCUs
  - Non-invasive measurements

$$\rho_{eff} = \left( \frac{K J \lambda_u \Omega_p}{8\pi\sqrt{2} c} \right)^{2/3} \quad K = \frac{eB\lambda_u}{2\pi m_e c} \quad \lambda = \frac{\lambda_u}{2\gamma^2} \left( 1 + \frac{K^2}{2} \right)$$

## Profile monitor screens

- Approaching optical resolution limits
- Need to suppress COTR for short bunches
- Limited to low repetition rate

## Wire scanners

- Devise new methods of supporting smaller diameter wires
- Fast wire scanning speeds needed for CW beams

# Profile Monitors to suppress COTR from Short Bunches

SLAC

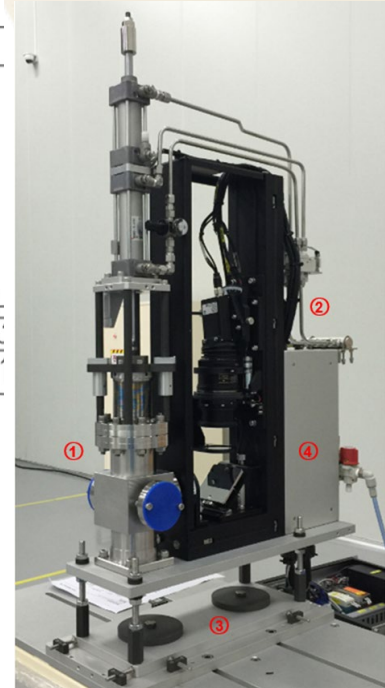
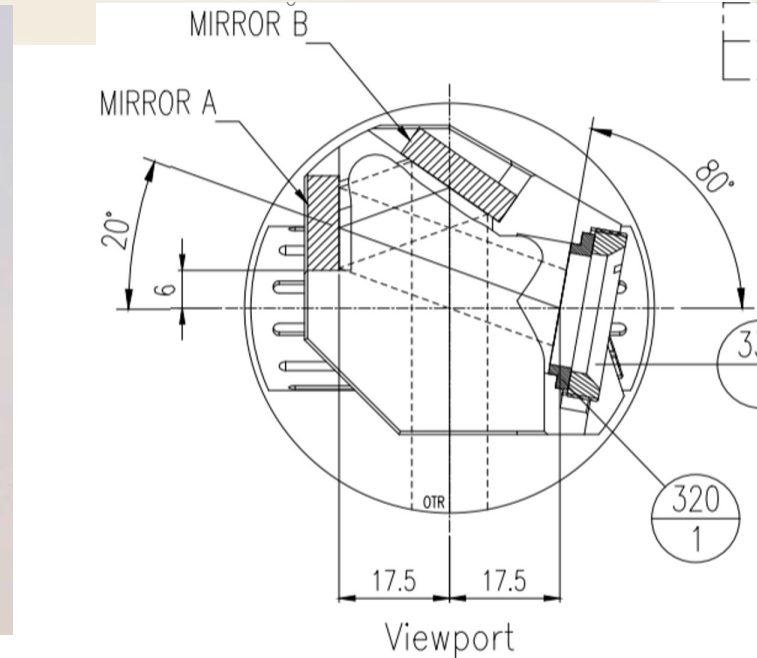
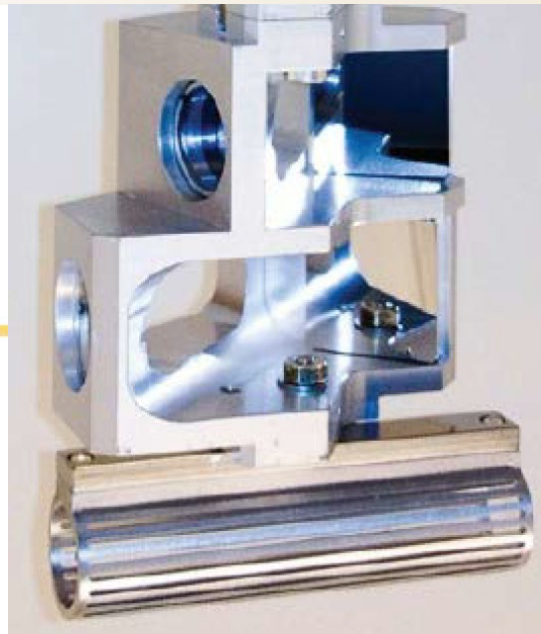
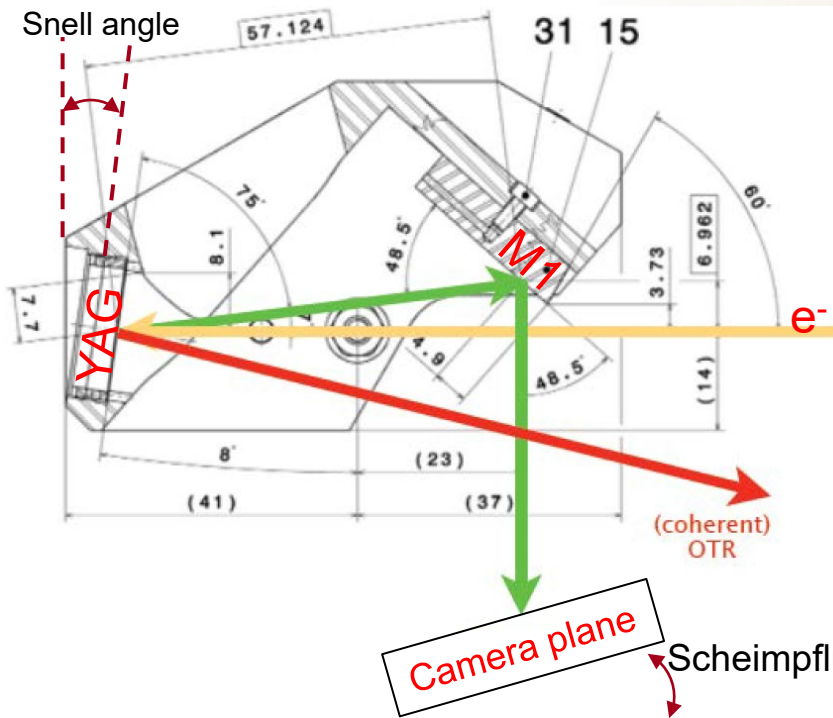

## R. Ischebeck PSI design

- Directs COTR away from camera
- Optimum optics for resolution
- Tested at LCLS SLAC/PSI collaboration

## C. Kim PAL design enhancement

- Adds 2<sup>nd</sup> mirror to increase spacing
- Same Snell/Scheimpflug optics
- Tested at LCLS SLAC/PAL collaboration
- Commercialized by Dae Heung



# SLAC LCLS Fast Wire Scanner

- Fast  $\sim 0.5\text{ms}^{-1}$  scanning speed
- At 1 MHz rep. rate  $\sim 100$  bunches intercepted while scanning a  $50\ \mu\text{m}$  beam
- $12.5\ \mu\text{m}$  Al:Si wire
- Vibration free operation
- High resolution  $\sim 1$ micron wire position read-back
- Beam synchronous acquisition of wire position during scan together with BLM signal

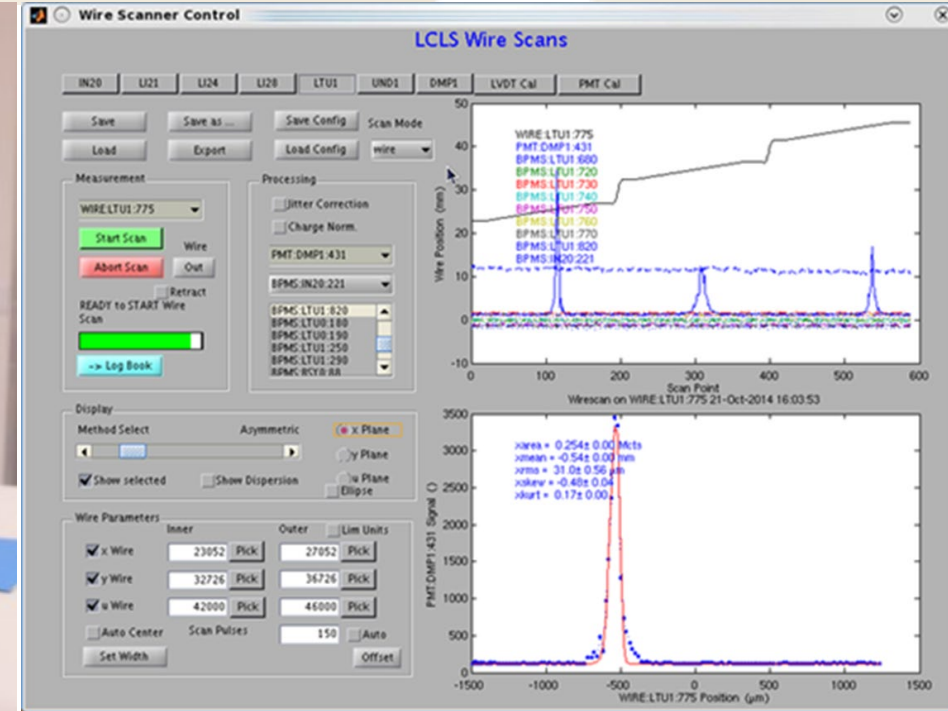
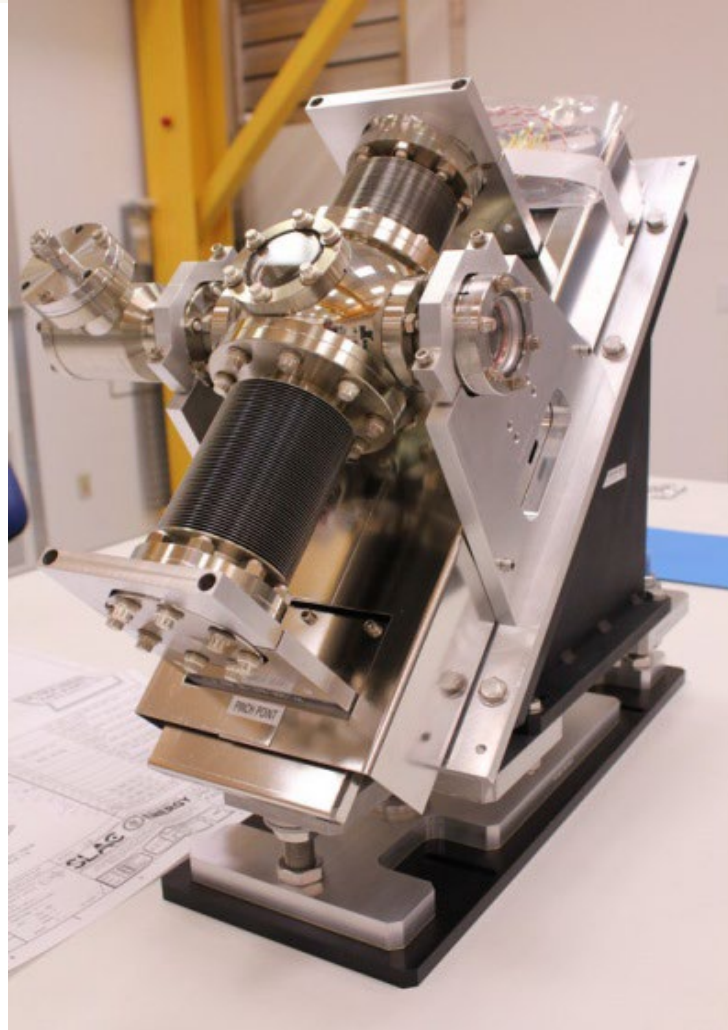

# Nano wires for sub-micron emittance – G. L. Orlandi PSI

SLAC

- PSI and FERMI are collaborating on nanofabrication techniques for sub-micron wires:

PSI **free-standing** WS chip: bulk Au stripe; width 800nm and 500nm; thickness  $\sim 2\mu\text{m}$

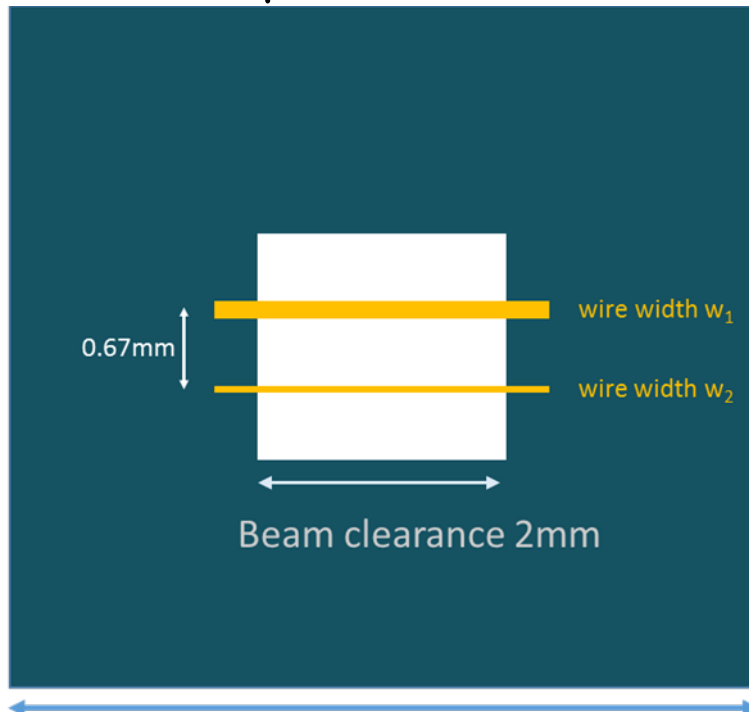

FERMI WS chip: **sandwich** Au/Si<sub>3</sub>N<sub>4</sub>/Au; thickness  $\sim 3\mu\text{m}$   
[Au(1 $\mu\text{m}$ ), Si<sub>3</sub>N<sub>4</sub>(2 $\mu\text{m}$ ), Ti(20nm)]

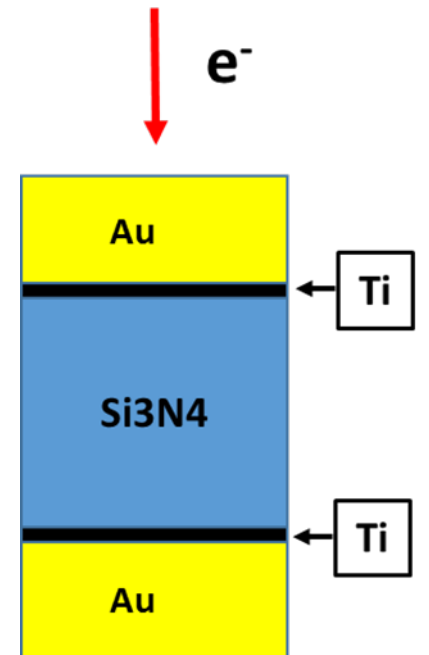
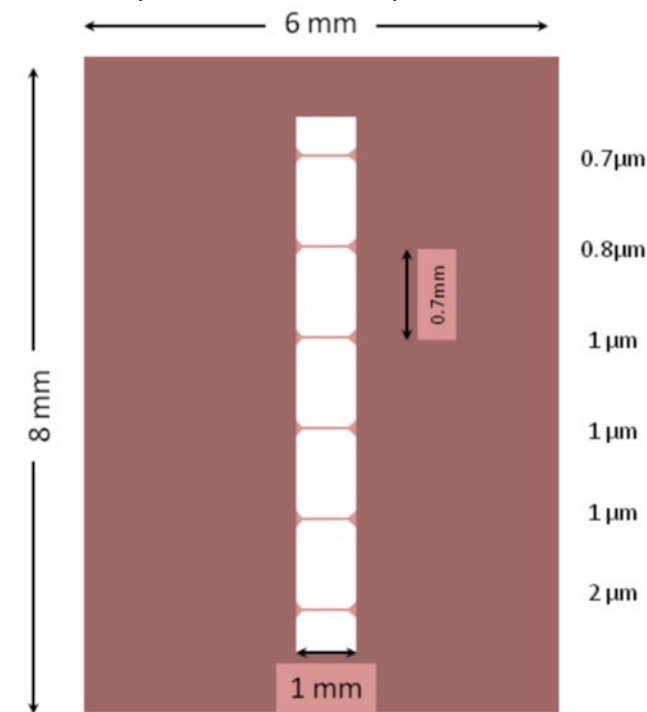

# Beam Measurements of Nanowires vs. YAG Screen

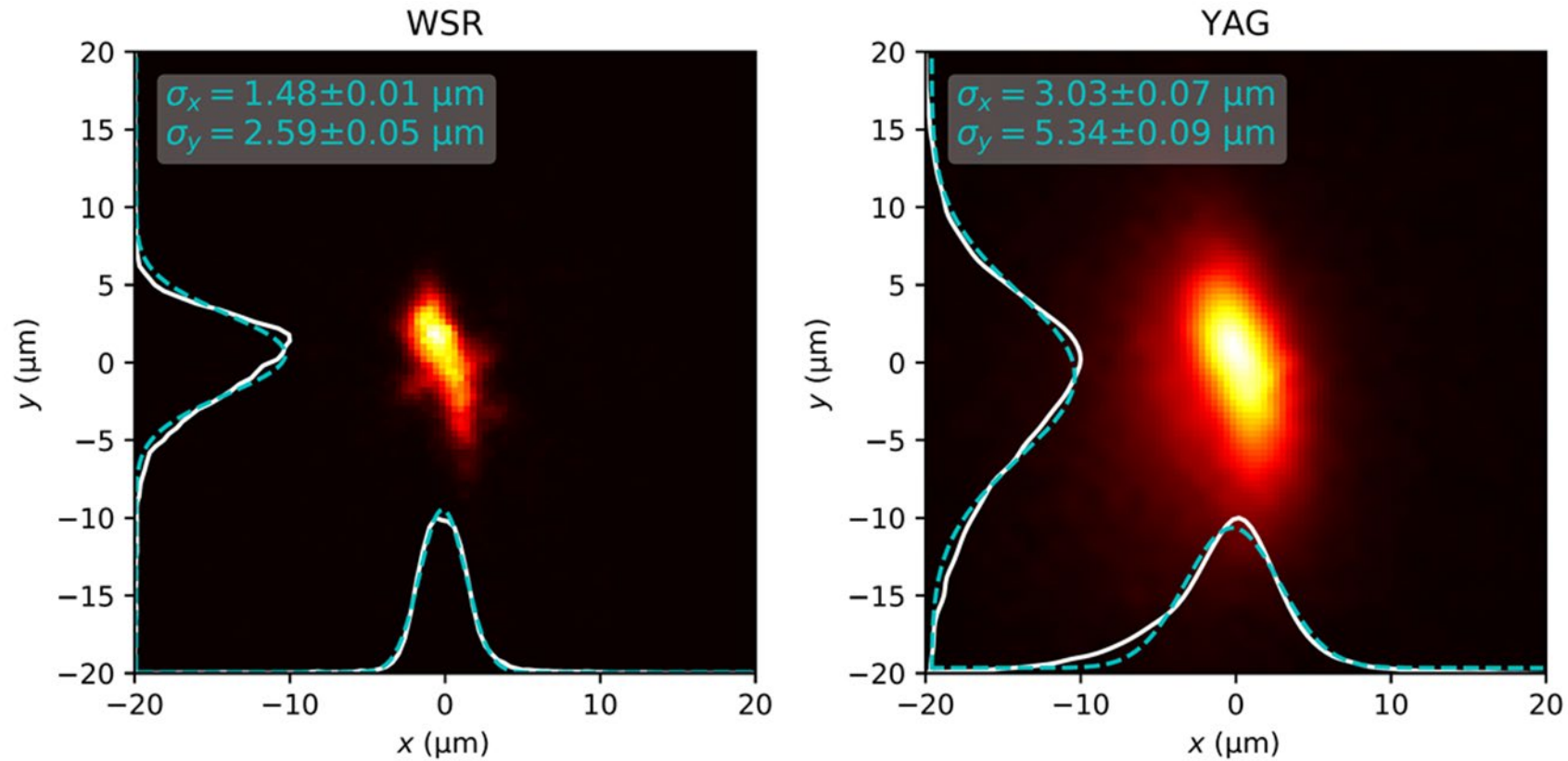

Same machine settings for WSR and YAG measurement, charge: 1 pC.

# Beam Position Monitor Challenges

Requirements driven by Beam-Based Alignment in the FEL.

Higher energy, lower emittance beams for new shorter wavelength hard x-ray FELs will have tighter resolution requirements

- Resolution requirements met with RF cavity BPMs
  - Can still achieve single-bunch acquisition at up to 1 MHz rates

A new challenge is integrating RFBPMs into SCU cryomodules and operating them at cryogenic temperatures.



# SLAC/PAL X-band RF Copper Cavity BPMs at LCLS

SLAC

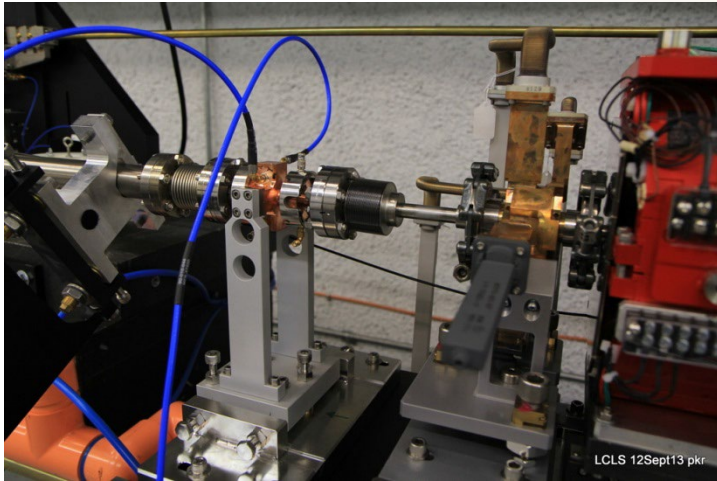

PAL Cavity installed adjacent to earlier LCLS Undulator BPM

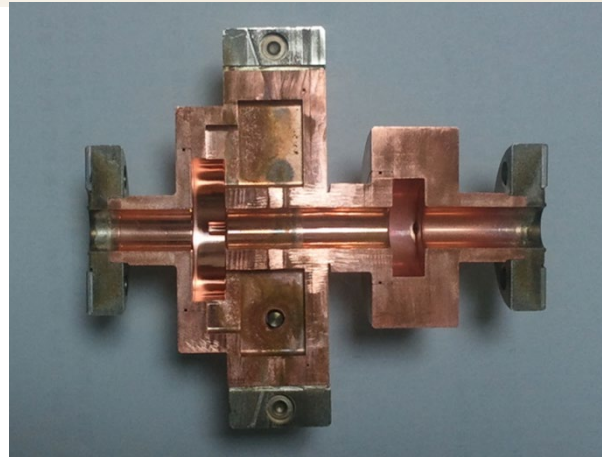

Sectioned example of PAL Cavity  
With a 0-mode cylindrical  
reference cavity and a cylindrical  
TM11 dipole mode cavity

Courtesy Changbum Kim

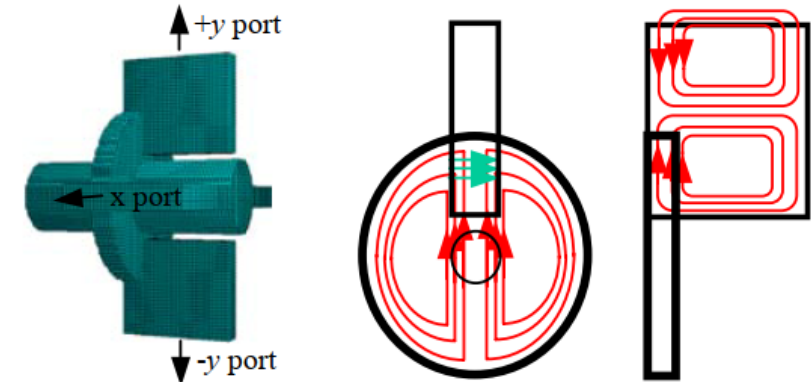

Two orthogonal selective  
dipole couplers for X and Y  
measurement

Z. Li

## Design issue:

- 4 tuning slugs are used on the dipole cavity to correct resonant frequency in X and in Y and minimize X-Y coupling.
- Note that one tuning slug breaks the cylindrical symmetry and introduces X-Y coupling
- Tuning therefore requires multiple iterations

# Issues for Operating a Cavity RFBPM at Cryogenic Temperatures

SLAC

- Dimensional and frequency changes during cool-down
- Remote tuning inside the cryomodule is difficult. Especially if iterations are required to minimize X-Y coupling
- Therefore opt for a simpler design with two separate rectangular X and Y dipole mode cavities
- One tuning pin per cavity. Predictable frequency change during cool-down.

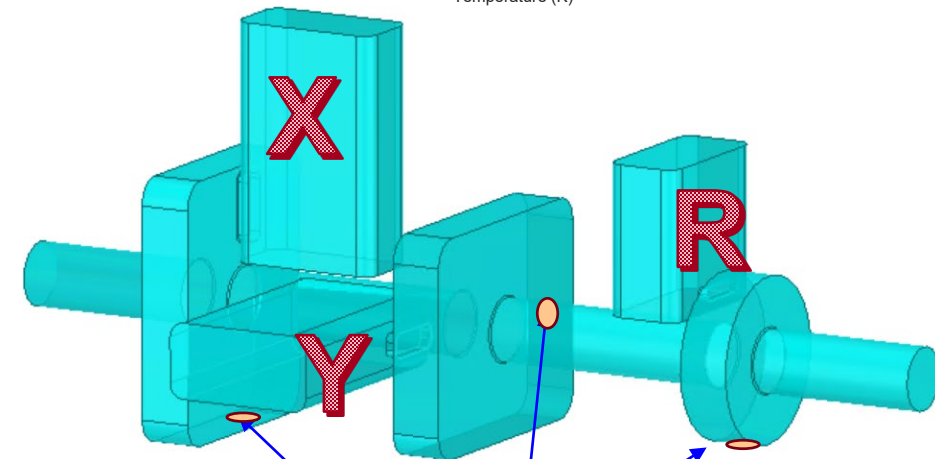
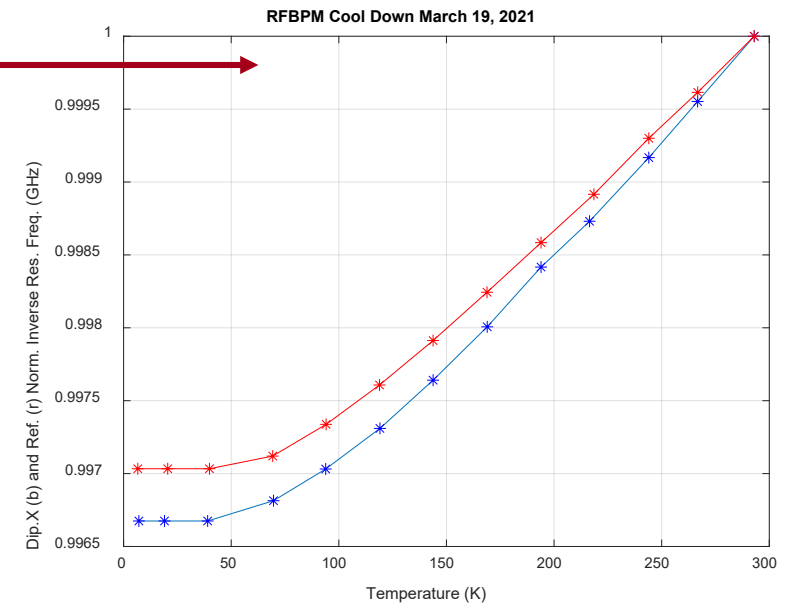

Courtesy C. Nantista

tuning pins

# Bunch Length Monitoring – edge radiation from dipoles



- Relative bunch length monitors are non-invasive and aid in tuning bunch compressors in the linac
  - And can operate with high repetition rate CW beams
- Absolute bunch length monitors add information about  $I_{peak}$ 
  - But need to make assumptions about the bunch distribution
- Example at LCLS-II
  - Courtesy Alan Fisher

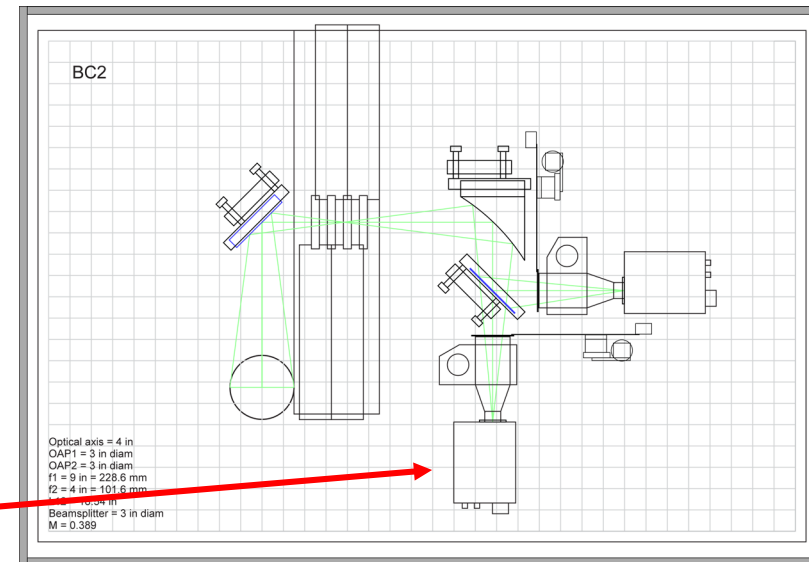
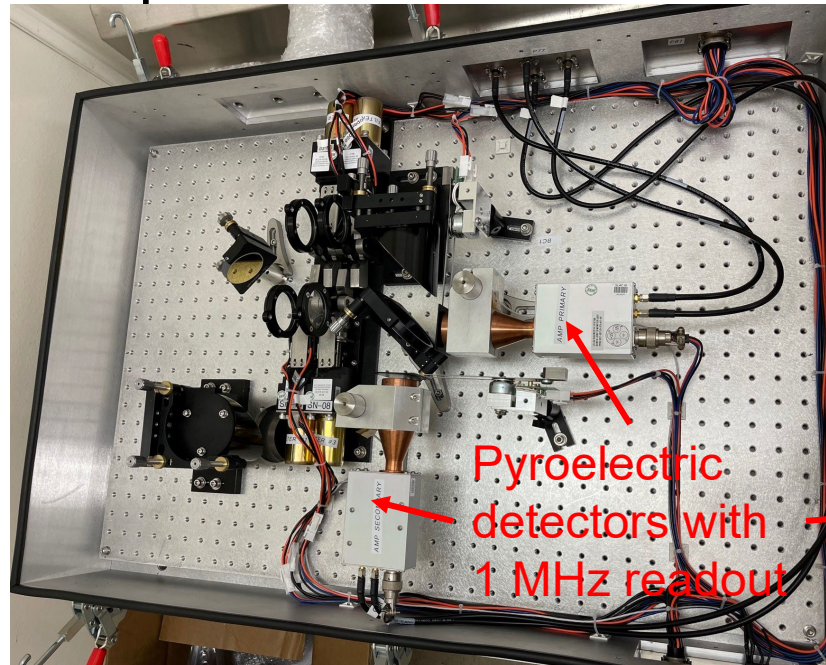

# Longitudinal Profile Measurement

- Streaking with a RF deflecting structure reveals the full longitudinal phase space and slice emittance
- Placed down stream of the undulator also reveals lasing temporal profile in the FEL (XTCAV)
  - Temporal resolution can be very good  $\sim 1$  fs
  - But, expensive, limited to  $\sim 120$  Hz operation and subject to phase jitter
- Passive wakefield deflectors can have similar resolution
  - Not limited in rep. rate, not subject to jitter, relatively inexpensive
  - But, nonlinear response only kicks the tail of the bunch
  - Also useful for two-bunch, two-color pump probe experiments



# The XTCAVs at the LCLS HXR and SXR

- The LCLS XTCAV provides non-invasive, single-bunch snapshots of the longitudinal phase space of the electron beam and is used for routine optimization of the undulator and electron beam parameters.
- It's location downstream of the undulator also allows reconstruction of the X-ray temporal profile which can be streamed to the user experiments on a shot-by-shot basis at 120 Hz.
- The XTCAV achieved an 8 times stronger kick than the original S-band deflecting structure by (4 times shorter wavelength and twice the field gradient).
- Resolution limit  $\sim 1$  fs

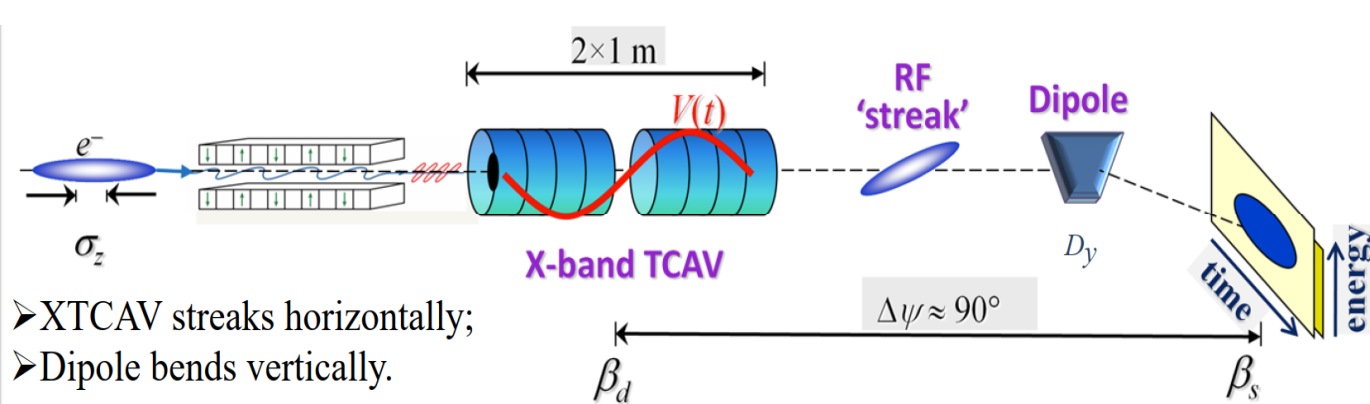
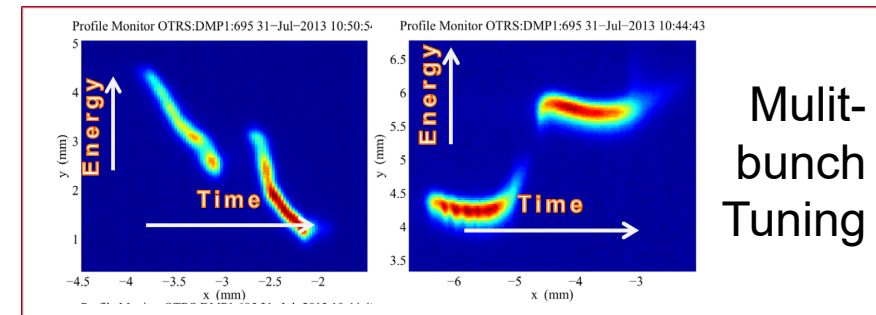
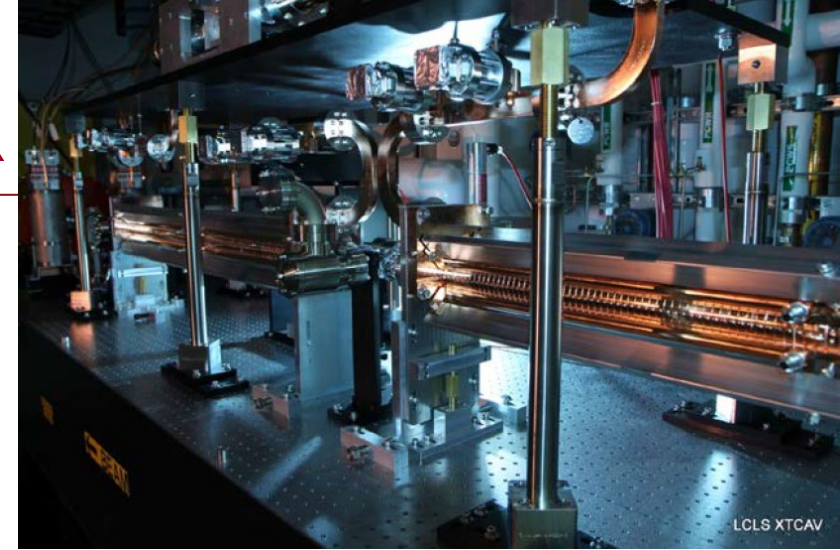

- XTCAV streaks horizontally;
- Dipole bends vertically.

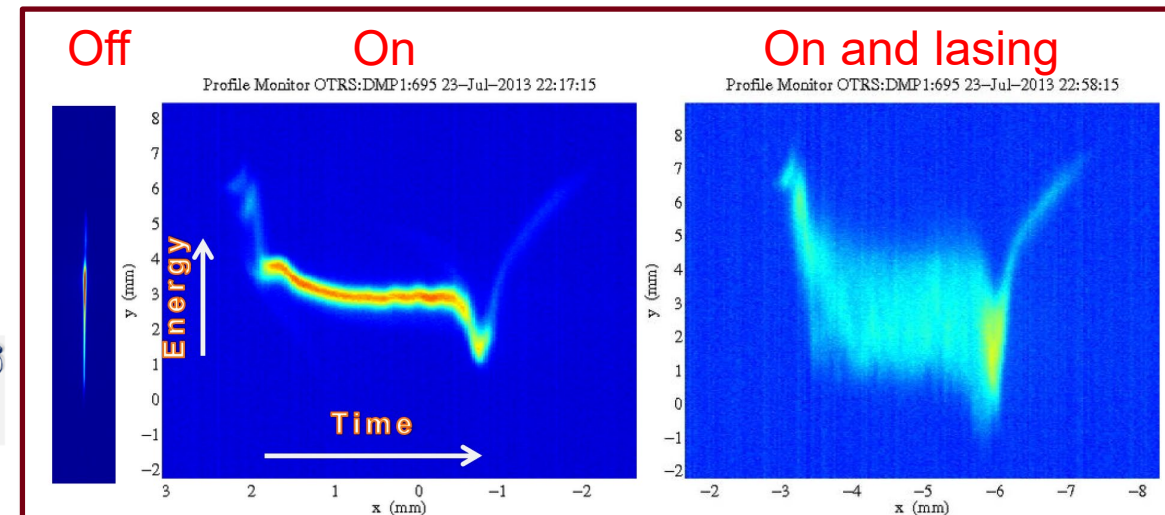

# Next Generation XTCAV – PolariX Variable Polarization

- CERN-PSI-DESY collaboration
- TDS with variable polarization

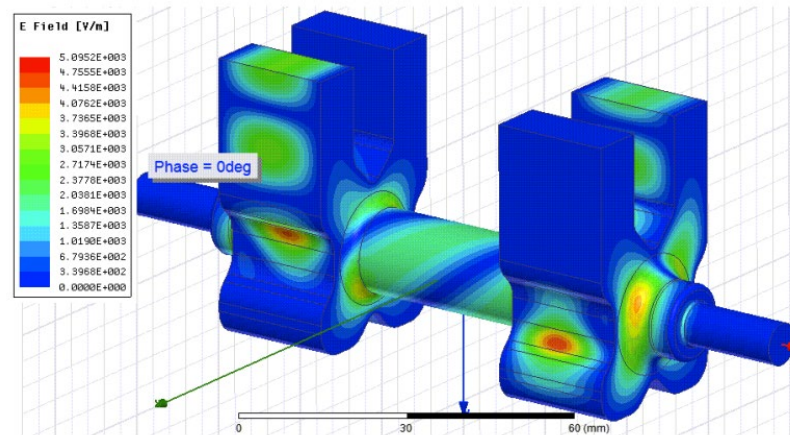
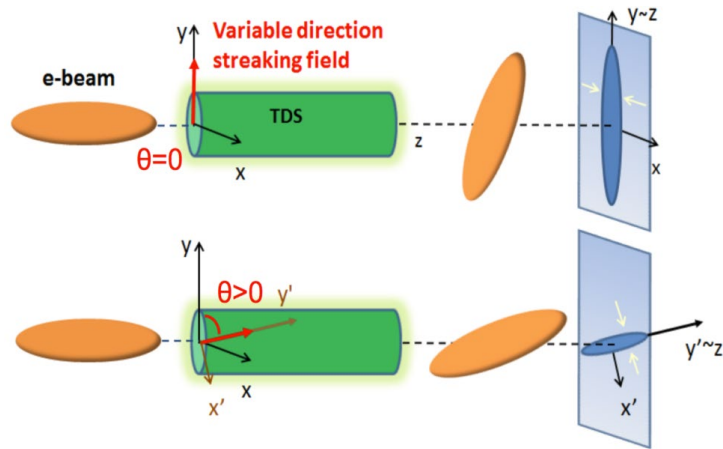

Courtesy  
P. Craievich, PSI

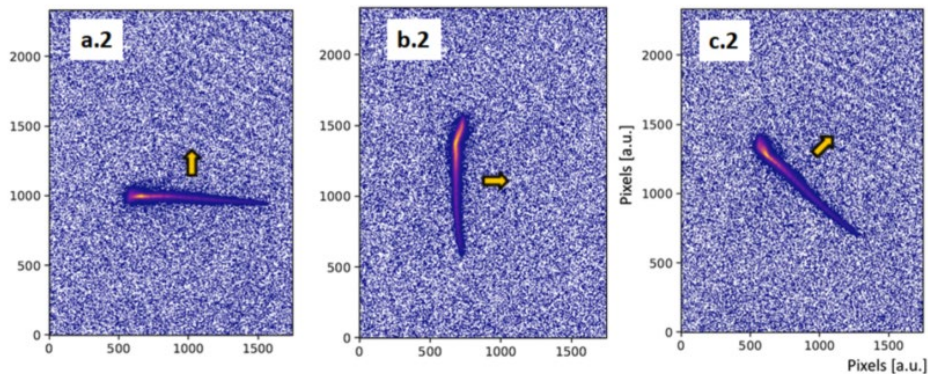

Courtesy  
B. Marchetti, DESY



# Resolution limits for powered deflectors (e.g. XTCAV)

- **The LCLS XTCAV** resolution is limited to  $\sim 1$  fs because of RF phase jitter from the klystron
  - RMS phase jitter of  $0.05^\circ$  X-band is adequate for operation, but a  $0.5^\circ$  flyer pulse will kick the beam out of its aperture and trip the beam loss monitors, interrupting user operation.
  - As a result we keep the drive power below its maximum amplitude
- **A next-generation deflector with attosecond resolution** must address three issues simultaneously
  1. The wavelength must be considerably shorter in order to increase the “streak”  $dV/dt$
  2. A high-power source must be available at the chosen wavelength
  3. The power source must be phase locked to the beam

# Passive deflectors

- Wakefield generated by the head of the bunch is used to kick the tail
- Wakefield created by electron bunch in close proximity to a corrugated or a dielectric surface
- Not subject to jitter like the powered deflector
- Kick is nonlinear over the length of the bunch
- Deflector can be quite long for high-energy beams
  - DESY structure is 5 m.
- Cost is reasonable compared to powered x-band deflector

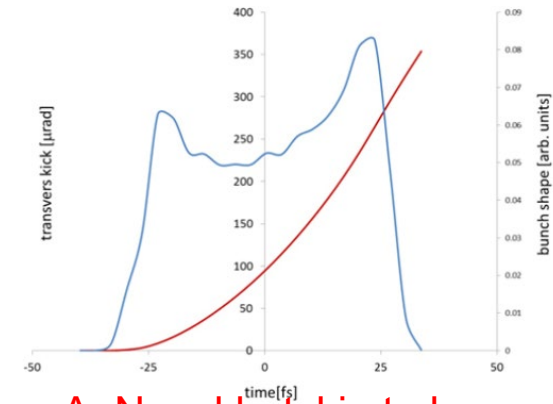

A. Novokhatski et al

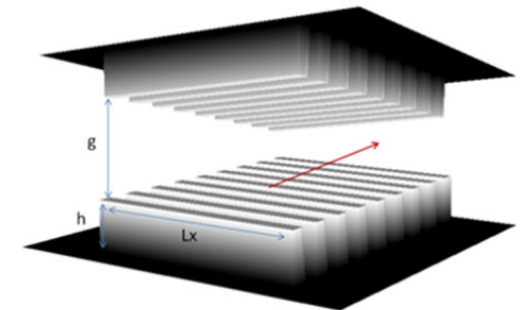

# SLAC

Iverson et al

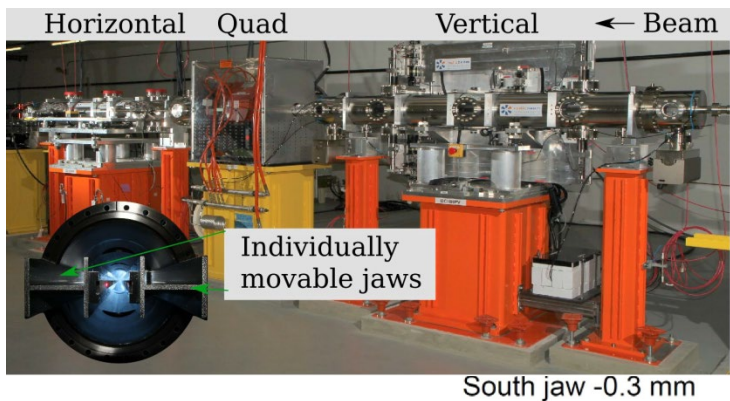

Located upstream of the undulator.

A. Novokhatski et al

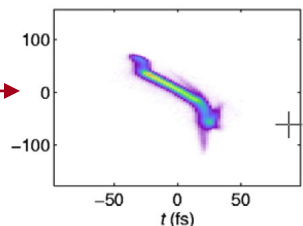

Used for fresh-slice two-color operation

A. Lutman et al

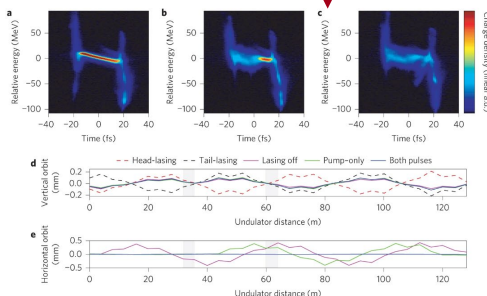
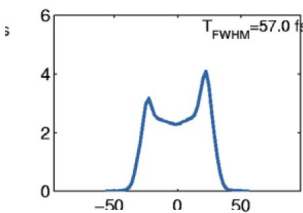

# DESY

Tomin et al

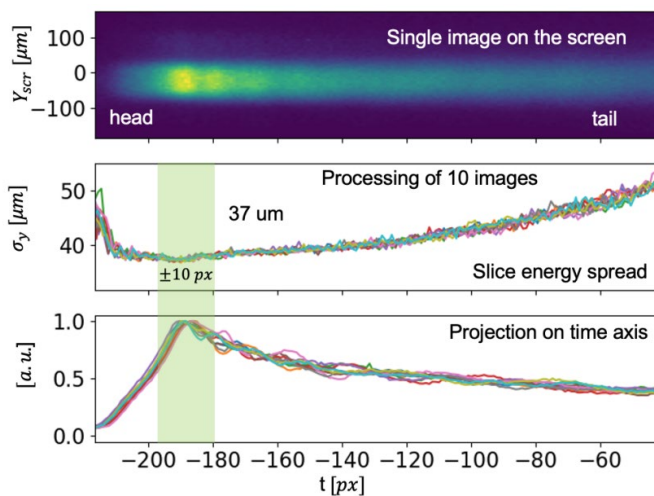
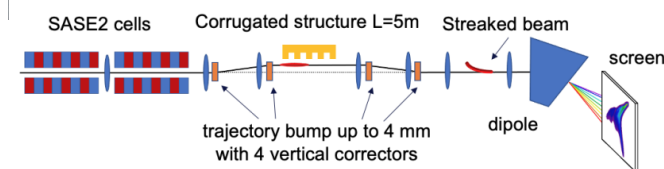
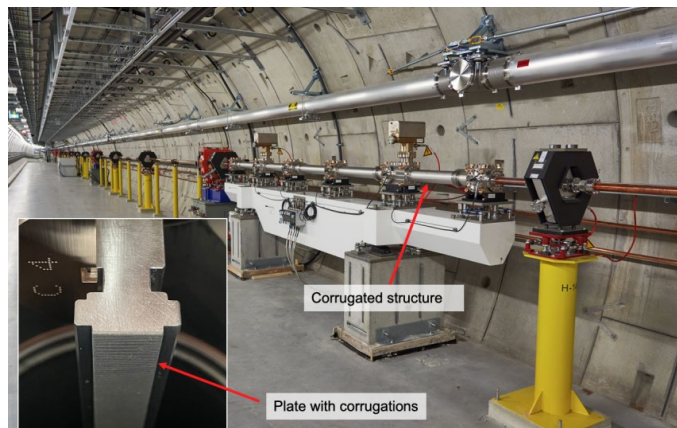

# PSI

Dijkstal et al

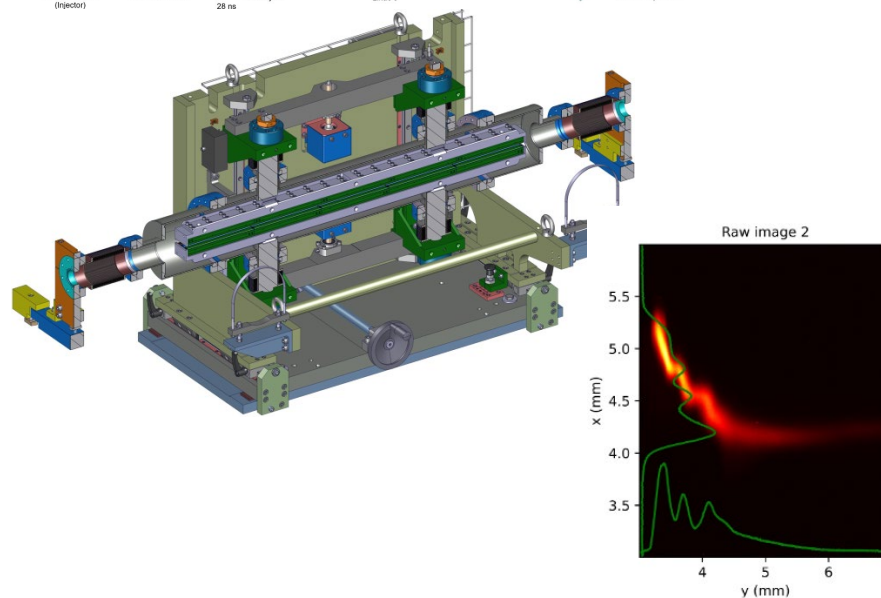
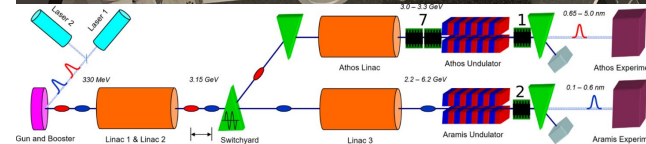
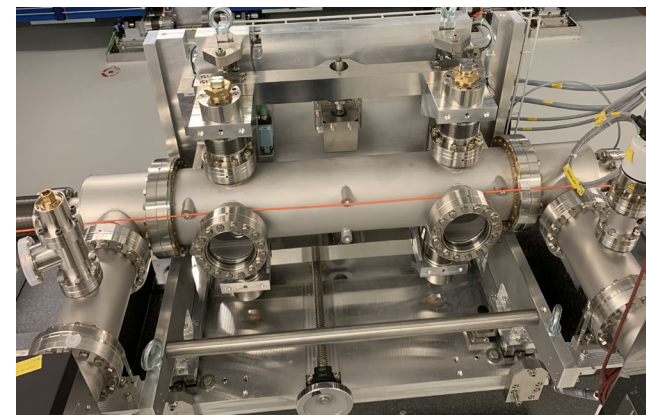

SLAC

# New Enhancements for Passive Deflectors

- SLAC is proposing an anodized aluminum dielectric bar as an alternative to machined corrugations (LDRD Proposal D. Bohler)
  - Cost effective, comparable kick strength, easier to water cool for high power beam operation ( $\sim 1$  kW/m at LCLS-II)
- Also adopt the **DESY innovation** to use an L-shaped bar to selectively kick in X- or Y-planes
- Or a combined kick in both planes
  - Cancels quadrupole wakes and doubles the kick.

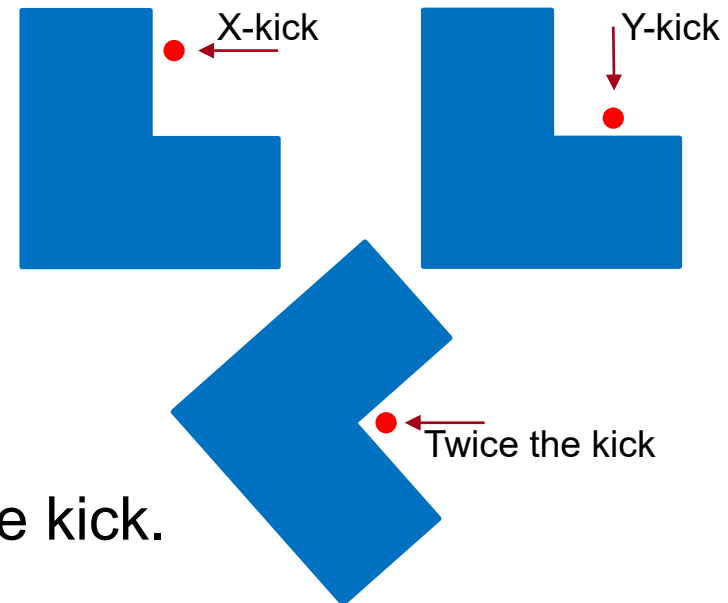

- Ultrafast science is now breaking the attosecond barrier
  - The resolution of a streaking device is governed by the kick amplitude (high gradient) and the wavelength  $\left(\frac{dV}{dt}\right)$
- $$\sigma_y^2 = \sigma_{y0}^2 + \beta_d \beta_s \sigma_z^2 \left( \frac{2\pi eV_0}{\lambda_{RF} E_s} \sin\Delta\psi \cos\phi \right)^2$$
- Two orders of magnitude improvement would be possible if we scaled from X-band to THz
  - Is there a high-power THz source that is phase-locked to the electron beam?



# Taking advantage of laser-based THz technology at SLAC UED

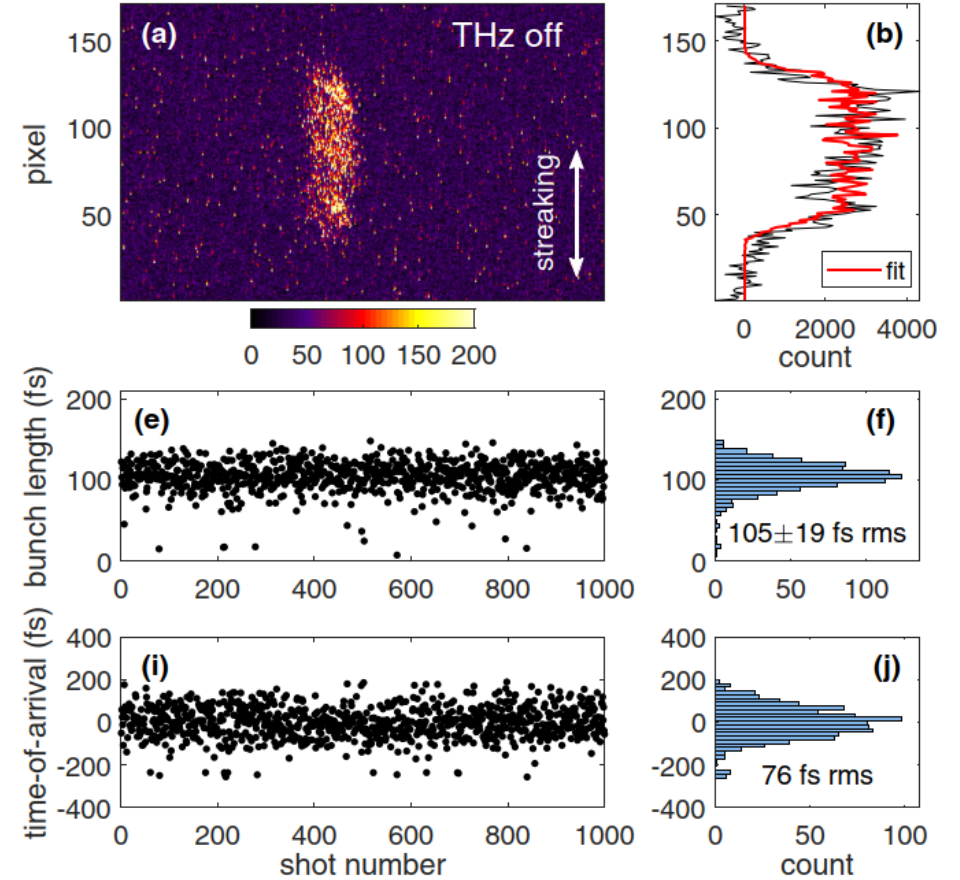
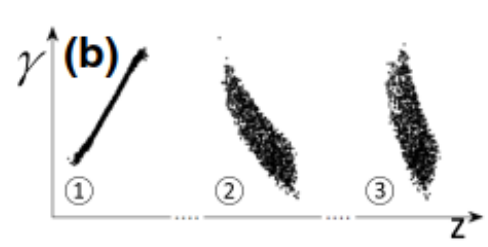
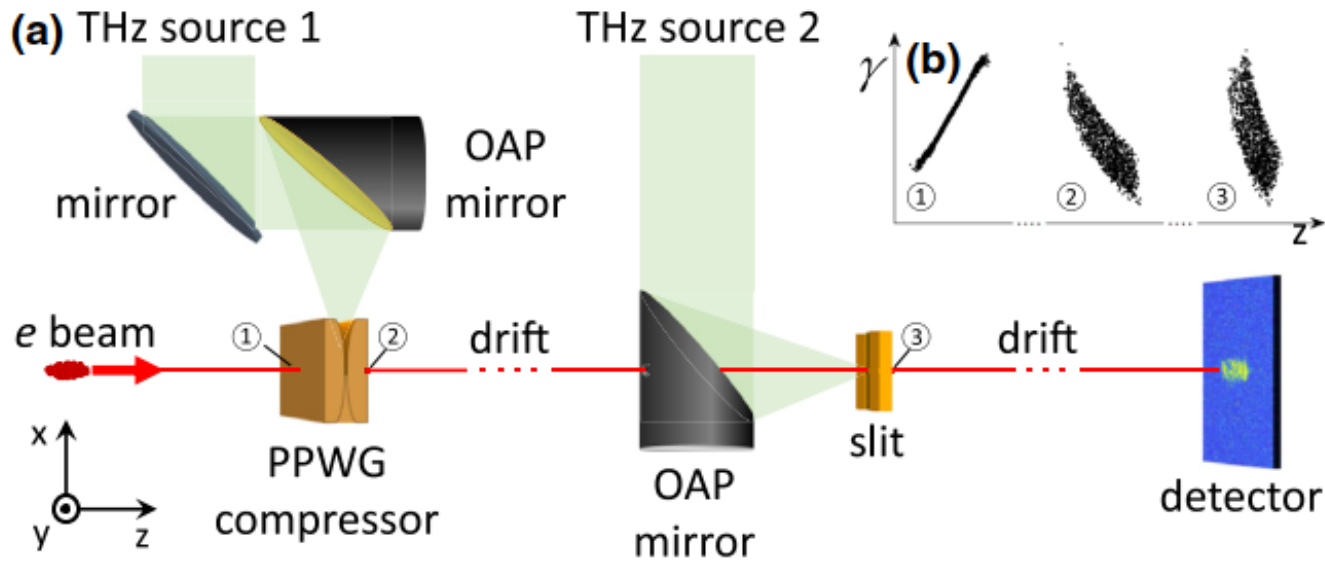

## Femtosecond Compression Dynamics and Timing Jitter Suppression in a THz-driven Electron Bunch Compressor

E. C. Snively<sup>1,\*</sup>, M. A. K. Othman<sup>1,†</sup>, M. Kozina<sup>1</sup>, B. K. Ofori-Okai<sup>1</sup>, S. P. Weathersby<sup>1</sup>, S. Park<sup>1,2</sup>, X. Shen<sup>1</sup>, X. J. Wang<sup>1</sup>, M. C. Hoffmann<sup>1,‡</sup>, R. K. Li<sup>1,§</sup> and E. A. Nanni<sup>1,||</sup>

<sup>1</sup>SLAC National Accelerator Laboratory, 2575 Sand Hill Road, Menlo Park, California 94025, USA

<sup>2</sup>Stanford Institute for Materials and Energy Sciences, SLAC National Accelerator Laboratory, Menlo Park, California 94025, USA

(Received 13 June 2019; revised manuscript received 30 December 2019; accepted 8 January 2020; published 4 February 2020)

- Demonstrates THz fabrication technology
- But still dependent on a jitter-prone, low-power external laser source



# SLAC Proposal for a Beam-Synchronous THz Deflector

- SLAC LDRD proposal P. Krejcik, V. Dolgashev, A. Fisher, D. Nguyen
- Exploit the spent FEL electron beam to make a high-power wiggler-based THz source that is inherently synchronous with the beam, and at the same repetition rate.

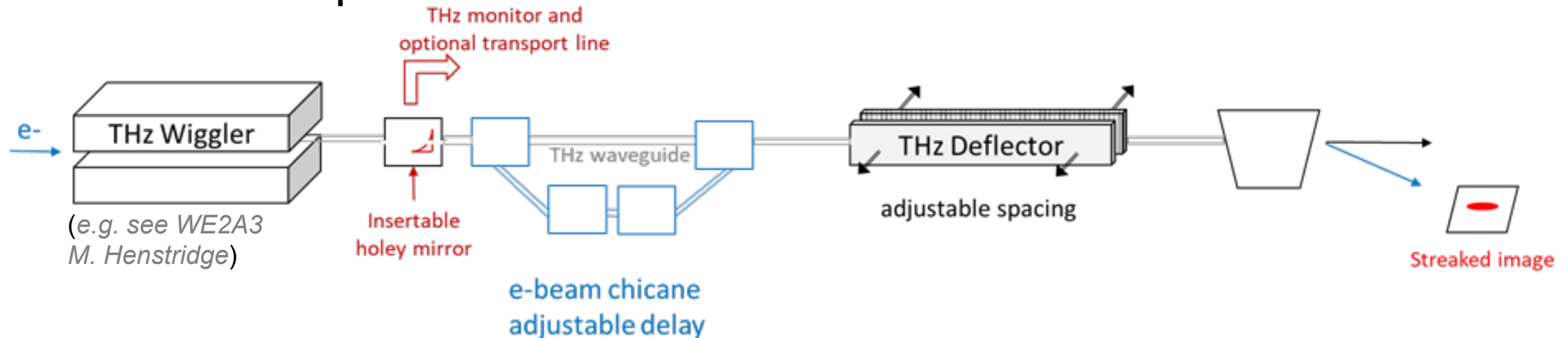

Variable chicane delay adjust the phase between the electron bunch and the THz deflecting field.

Planar deflecting structure with variable spacing to allow large beam stay-clear during setup.

- Not every diagnostic instrument was covered. There are many more required for an operating FEL facility (arrival time monitors, loss monitors, data acquisition systems etc.).
- The emphasis was on those systems that will be challenged by the push to higher performing X-ray FELs
  - Smaller transverse beam size measurements needing greater resolution with minimal invasiveness
  - Tighter alignment tolerances needing higher resolution BPMs operating at cryogenic temperatures
  - Longitudinal bunch length profile measurements in the attosecond regime
  - All the while dealing with higher beam power and repetition rate.

# Thank You

And grateful acknowledgements to my accelerator colleagues for their valuable input and ideas.