

ECC-ee MDI: Trapped modes and other power losses.

Alexander Novokhatski

SLAC

65th ICFA Advanced Beam Dynamics Workshop on High Luminosity Circular e+e-
Colliders (eeFACT2022)

September 13, 2022



Historically the FCC IR beam pipe got several modifications.
Precise wake field simulations using the CST code were impossible
without CAD models, developed by

Miguel Gil Costa

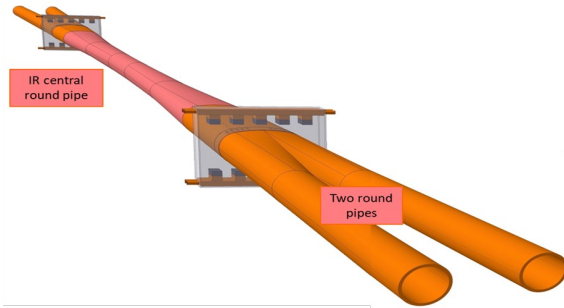

Luigi Pellegrino

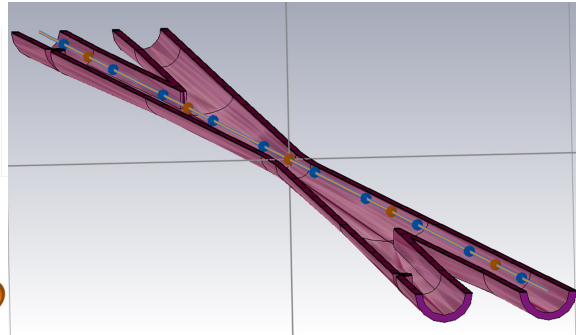

Francesco Fransesini

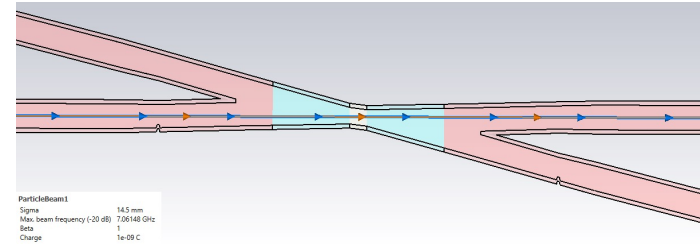

Outline

- I. Electromagnetic fields in IR
- II. A concept of a low impedance IR beam pipe
- III. Wake fields and trapped modes.
- IV. Heat load coming from the circulating beams.
- V. A CAD model for heat load calculations from Francesco Franesini
- VI. Results for wake potentials
- VII. Heat load distribution in IR.
- VIII. Summary



Electromagnetic fields in IR

- We may consider three types of electromagnetic fields exciting in IR by colliding beams:
 1. Propagating waves that can leave IR and then be absorbed somewhere in the rings
 2. Electromagnetic fields that can be trapped and absorbed in IR (RF trapped modes). Under resonant conditions these trapped mode fields can be strongly magnified.
 - One mode located near the pipe connection is an unavoidable mode.
 3. There are also unavoidable resistive-wall wake fields that are responsible for directly heating of the metal walls.



The concept of a low impedance IR beam pipe

Smooth transitions at the pipe connections

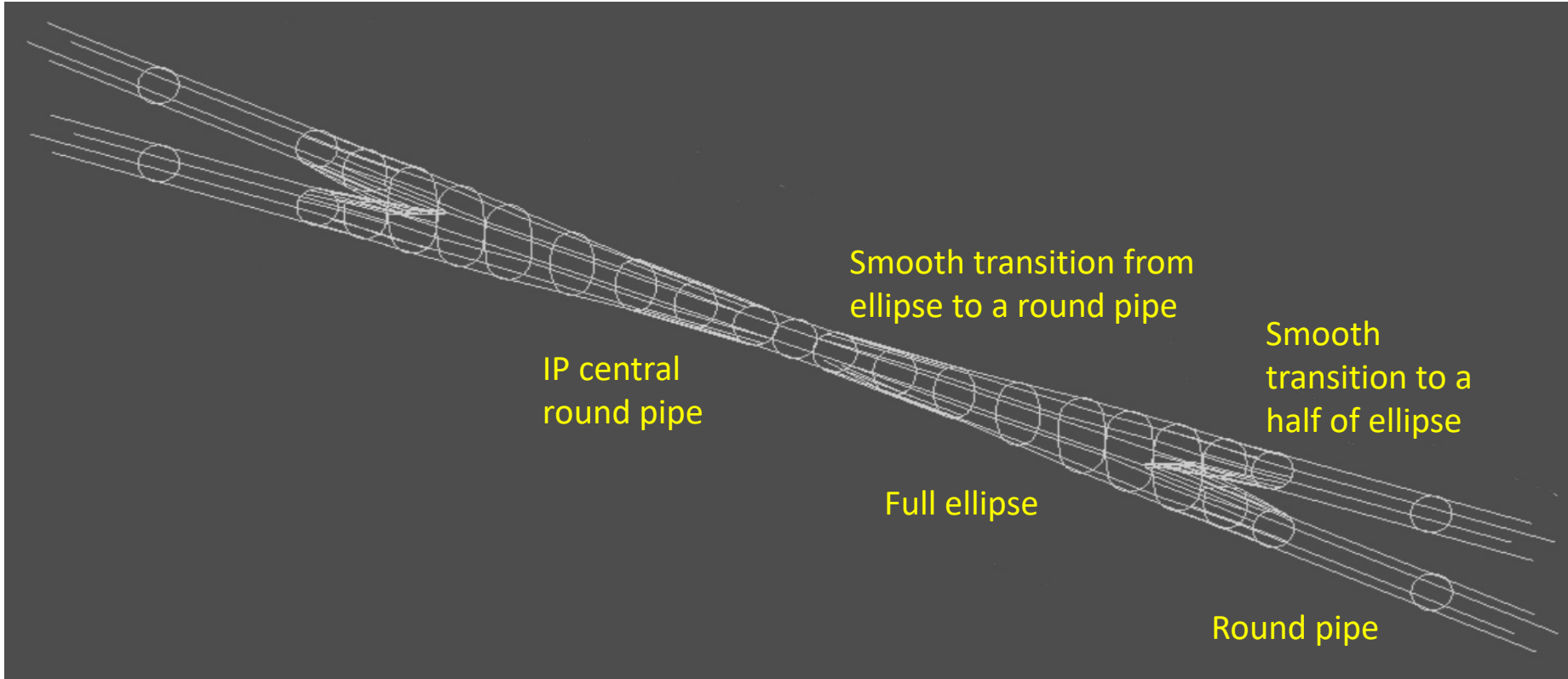

Importance of the dimensions of the beam pipe

- Initial model proposed equal diameters of the beam pipe tube at the collision center and incoming pipes
- At this condition we have an unavoidable trapped mode

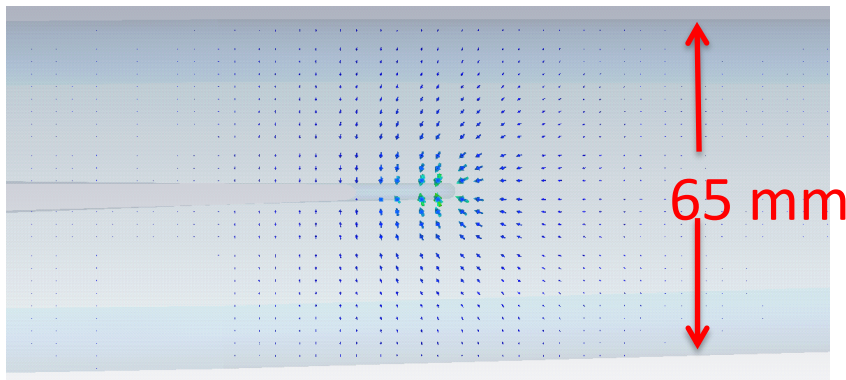

This trapped mode is localized in the region where two beam pipes emerge into one. This mode has mainly transverse electrical component near the incoming pipe connection, but also longitudinal components near the edge. In this way the beam excites this mode.



Spectrum and cumulative spectral density of the energy losses

$$P_{HOM} = 2I^2 k_{HOM} \tau_{l,HOM}$$

$$P_{prop} = I^2 (k - k_{HOM}) \times \tau_b$$

PHYSICAL REVIEW ACCELERATORS AND BEAMS 20, 111005 (2017)

Unavoidable trapped mode in the interaction region of colliding beams

Alexander Novokhatski¹ and Michael Sullivan
 SLAC National Accelerator Laboratory, Menlo Park, California 94025, USA

Eleonora Belli, Miguel Gil Costa, and Roberto Kersevan
 CERN, 1211 Geneva 23, Switzerland

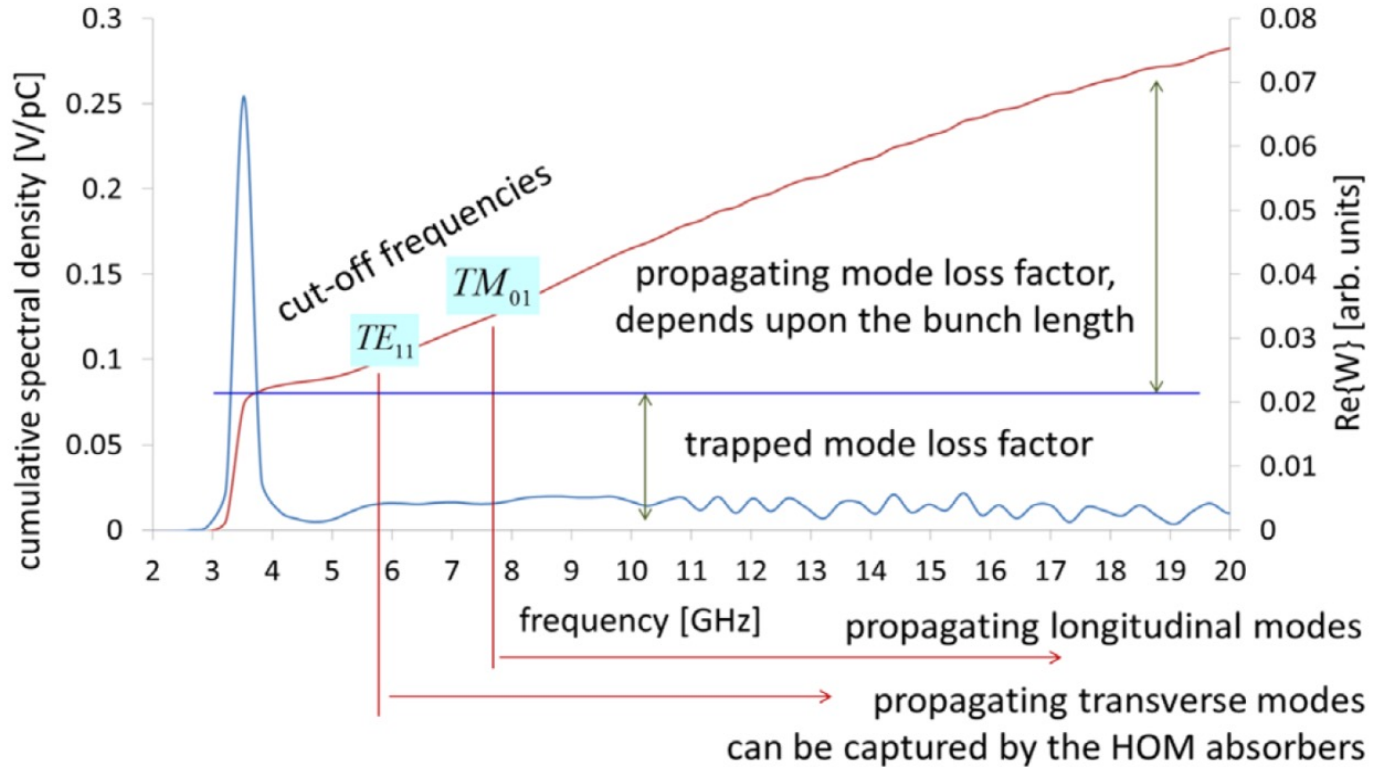

Improvement of the beam-mode interaction

Careful study of the structure of a trapped mode shows that the excitation power can be decreased by a small variation of the shape in the area of the beam pipe connection.

Elliptical shape.
Initial design.

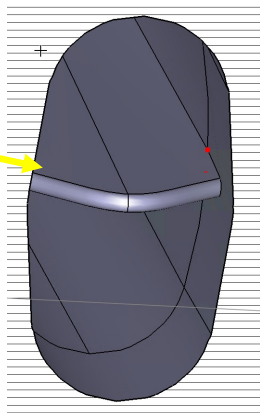

Flattened shape.
Must move trapped mode frequency higher

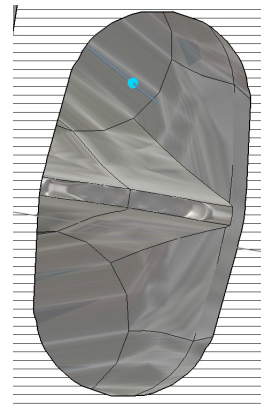

The main idea was to push higher the trapped mode frequency ω_0 . This means that interaction of the trapped mode with a bunch of finite length σ will be diminished, and the excitation power will go down as

$$\frac{P_{[\Delta\omega]}}{P} \sim \exp\left(-2 \frac{\Delta\omega}{\omega_0} \left(\omega_0 \frac{\sigma}{c}\right)^2\right)$$



Wake field, impedance and loss factor comparison

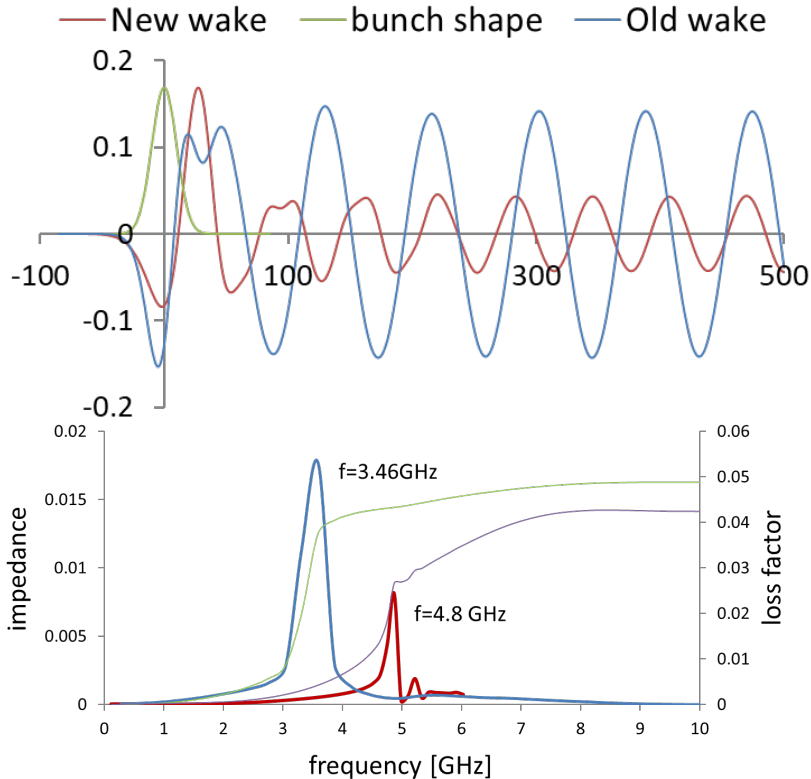

The “flattened” shape of intersection has a twice less amplitude of the trapped mode oscillations (red line) in comparison with the “elliptical” shape (blue line)

The frequency of the trapped mode of the modified intersection is 40% higher, and, impedance is two times less and total loss factor is smaller by 20%



Estimates of heating power in trapped modes and propagating waves.

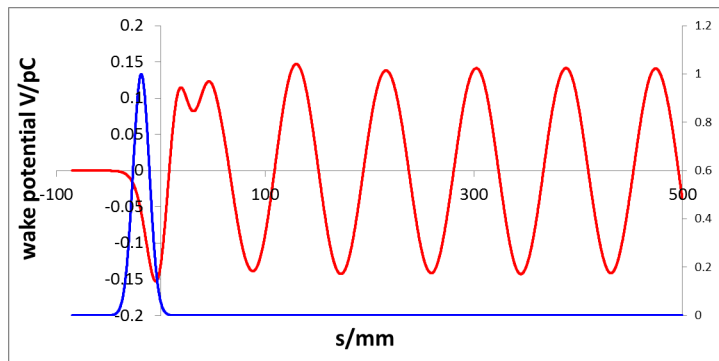

Wake potential of a 10 mm bunch, clearly seen excitation of a trapped mode with an additional higher frequency staff

In the extreme case (shorter bunches) each beam of 1.45 A will produce electromagnetic power of approximately 5 KW from both connections.

To absorb this power we have designed a special water-cooled HOM absorber, which can capture the trapped mode and some part of the propagating waves.



The concept of the HOM absorber

Based on the property of the trapped mode we have designed a special HOM absorber.

The absorber vacuum box is placed around the beam pipe connection. Inside the box we have ceramic absorbing tiles and copper corrugated plates .

The beam pipe in this place have longitudinal slots, which connect the beam pipe and the absorber box. Outside the box we have stainless steel water-cooling tubes, braised to the copper plates.

The HOM fields, which are generating by the beam in the Interaction Region pass through the longitudinal slots into the absorber box.

Inside the absorber box these fields are absorbed by ceramic tiles, because they have high value of the loss tangent.

The heat from ceramic tiles is transported through the copper plates to water cooling tubes.

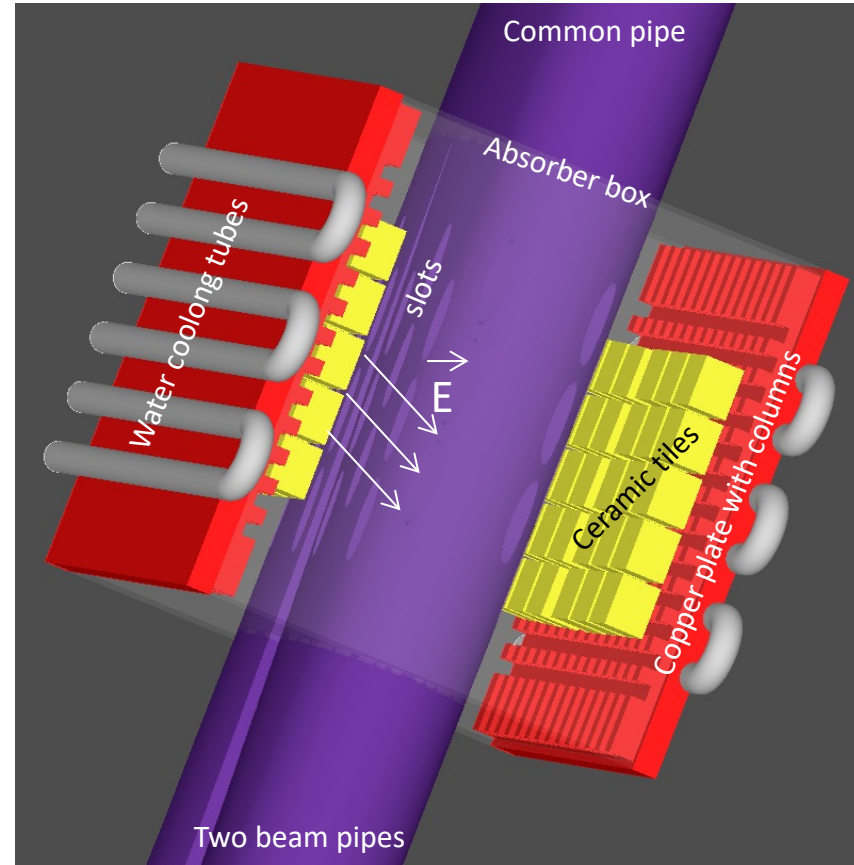

Smaller central beam pipe

- As a request for further improvement of the Interaction Region, we analyze the possibility of modifying the IR beam pipe for a smaller diameter of the central beryllium pipe to 20 mm. This modification gives more freedom for the FCC detector to make more efficient tracking.
- A smaller center pipe will improve (decrease) the geometrical impedance.
- However, the heat load due to resistive wake field will be higher and may be require more cooling.



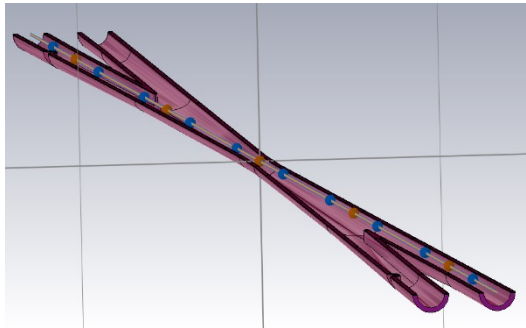

CAD file is based on this geometry

Different metal part around the beam trajectory

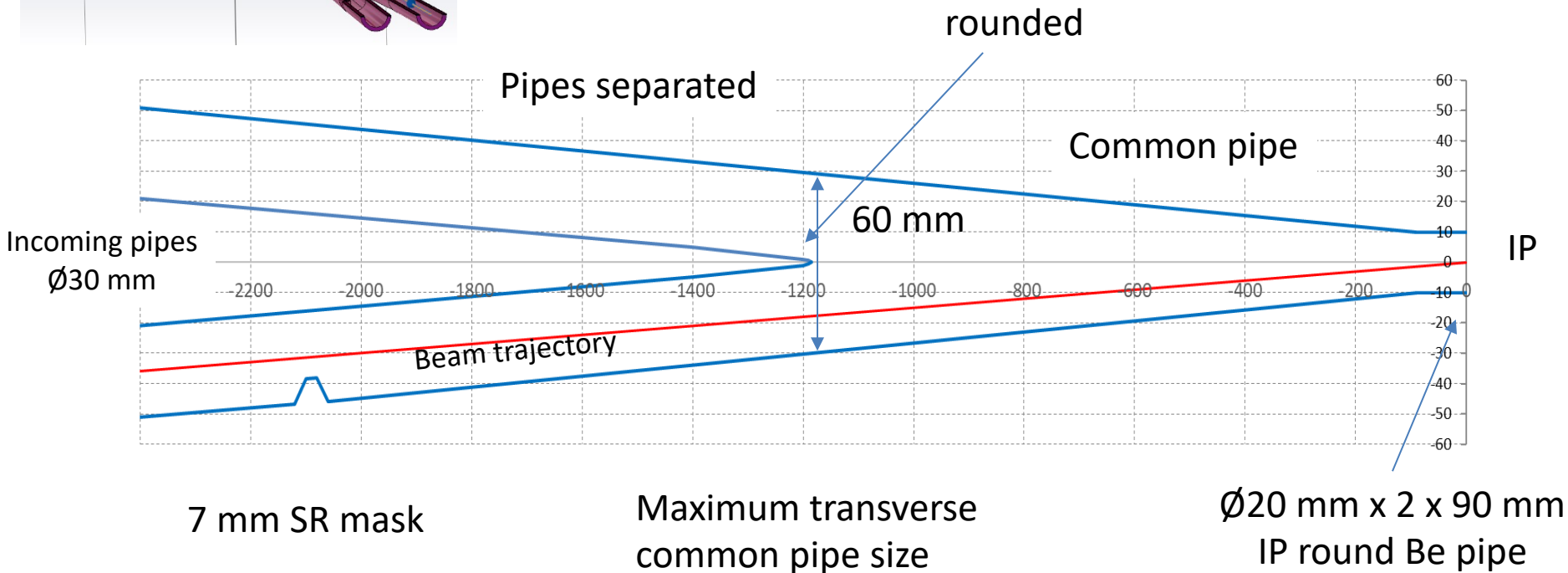

An unavoidable trapped mode still exists, but has much smaller amplitude due to much higher frequency 6.1 GHz

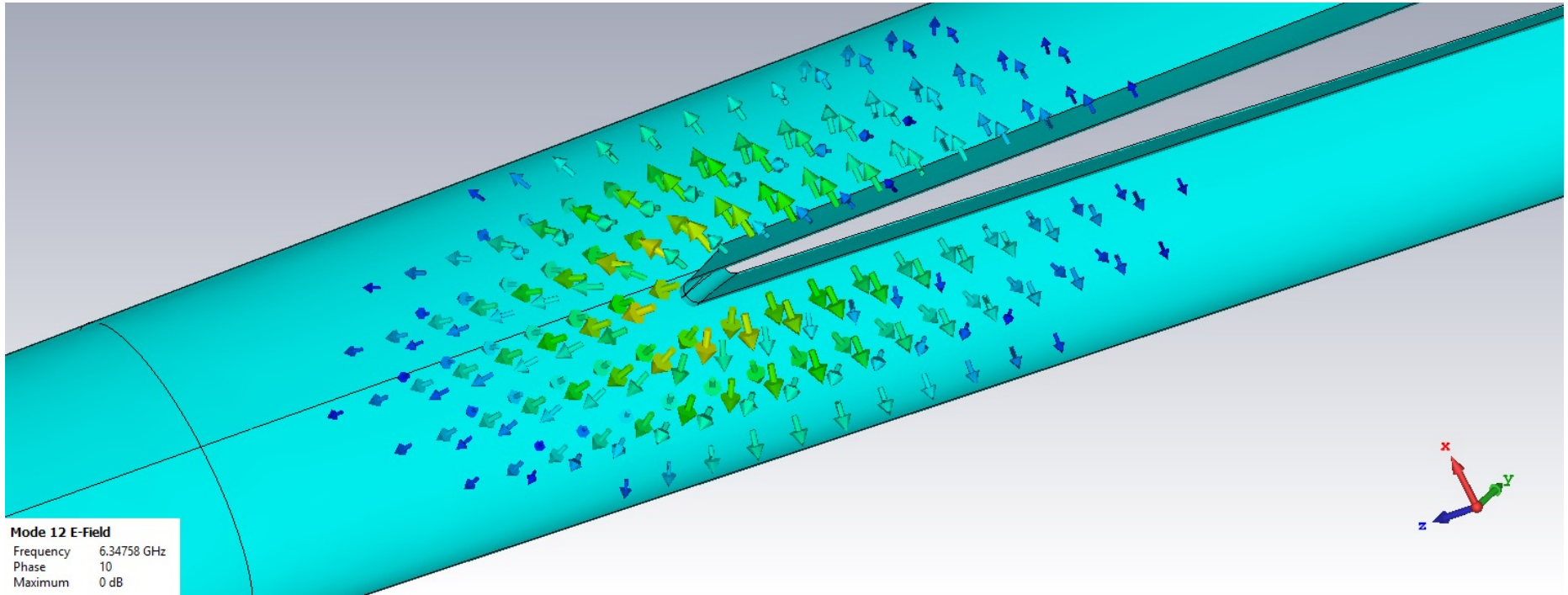

Other modes in IR

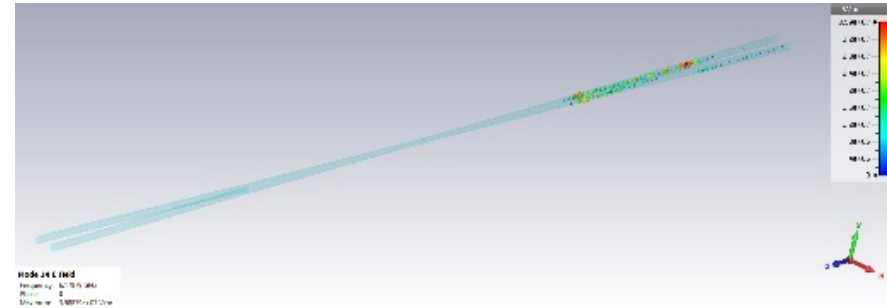
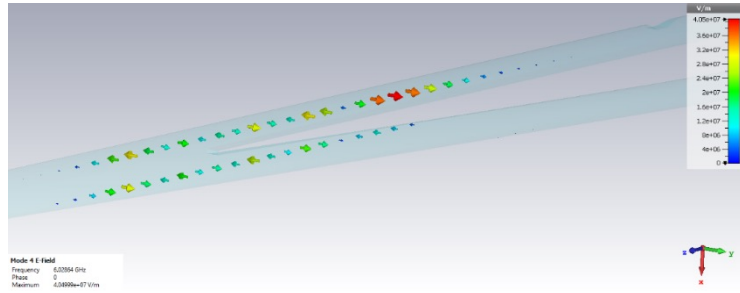
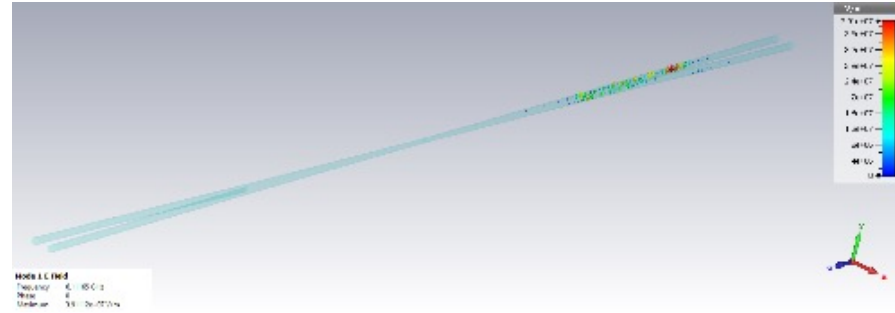
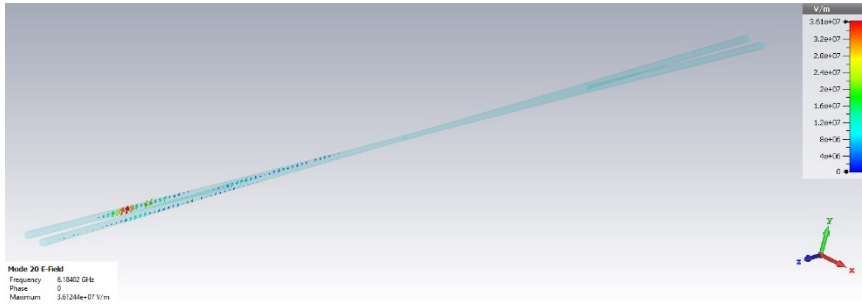

Details of field distribution

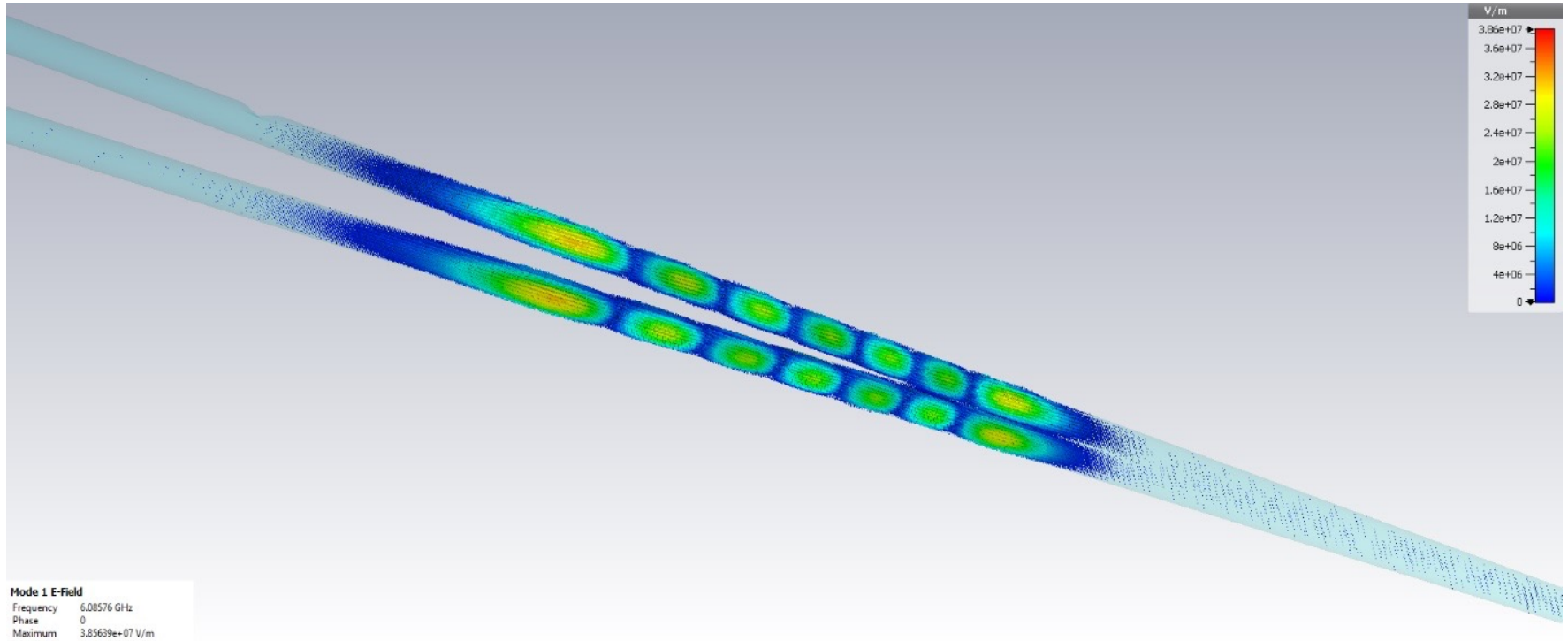

Modes are distributed between a beam pipe connection and a mask



Heat load: electromagnetic power of wake fields

All electromagnetic waves, exciting by the beam will be absorbed by the beam pipe walls or inside some accelerating components.

Here is a general formula to estimate the heat load from one beam

$$P = k\tau I^2$$

Power = Loss factor \times bunch spacing \times Current²

$k\tau$ can be consider as an overall resistance of the beam pipe

For two colliding beams the power is usually doubled

I checked this formula practically during PEP-II Operation with record beam currents. It really works.



Parameter [4 IPs, 91.2 km, $T_{rev}=0.3$ ms]

Parameter [4 IPs, 91.2 km, $T_{rev}=0.3$ ms]	Z	WW	H (ZH)	ttbar
beam energy [GeV]	45	80	120	182.5
beam current [mA]	1280	135	26.7	5.0
number bunches/beam	10000	880	248	36
bunch intensity [10^{11}]	2.43	2.91	2.04	2.64
SR energy loss / turn [GeV]	0.0391	0.37	1.869	10.0
total RF voltage 400/800 MHz [GV]	0.120/0	1.0/0	2.08/0	4.0/7.25
long. damping time [turns]	1170	216	64.5	18.5
horizontal beta* [m]	0.1	0.2	0.3	1
vertical beta* [mm]	0.8	1	1	1.6
horizontal geometric emittance [nm]	0.71	2.17	0.64	1.49
vertical geom. emittance [pm]	1.42	4.34	1.29	2.98
horizontal rms IP spot size [μm]	8	21	14	39
vertical rms IP spot size [nm]	34	66	36	69
beam-beam parameter ξ_x / ξ_y	0.004/ .159	0.011/0.111	0.0187/0.129	0.096/0.138
rms bunch length with SR / BS [mm]	4.38 / 14.5	3.55 / 8.01	3.34 / 6.0	2.02 / 2.95
luminosity per IP [$10^{34} \text{ cm}^{-2}\text{s}^{-1}$]	182	19.4	7.3	1.33
total integrated luminosity / year [ab^{-1}/yr]	87	9.3	3.5	0.65
beam lifetime rad Bhabha + BS [min]	19	18	6	9

Old and new beam parameters (heat power increase concern)

Parameter	Old	New	Change
Beam Current	1.39 A	1.28 A	-15 % (I^2)
Bunch spacing	19.5 ns	32 ns	+64 %
Heat power change			+39 %
Loss factor depends on bunch length	12 mm	15.9 mm	-30% may help



Heat load depend on the materials we use

- For detector operation Be is good
- For vacuum NEG may be used
- For minimum heat load from wake fields Silver, Gold, Copper

Material	Cu	Au	Al	Be	Ni	SS	NEG
conductivity [Ohm/mm]	58000	48800	35000	25000	14600	1400	50 -->1000

- May be coating?
- Example from the KEKB IR.
- KEKB IR has the same dimension of the central beam pipe.



NEG with a conductivity of 100 Ohm/mm

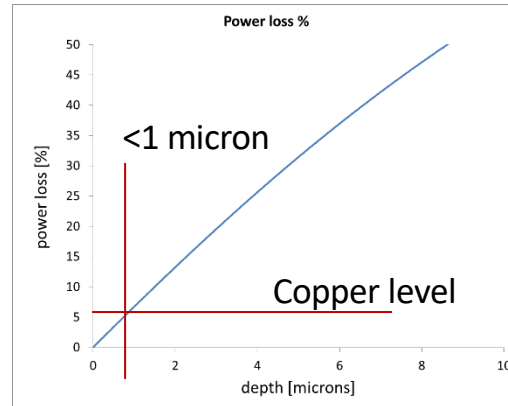

NEG coating must be less than 1 micron to have the same heat load as copper walls.



KEKB IP pipe (Kyo Shibata)

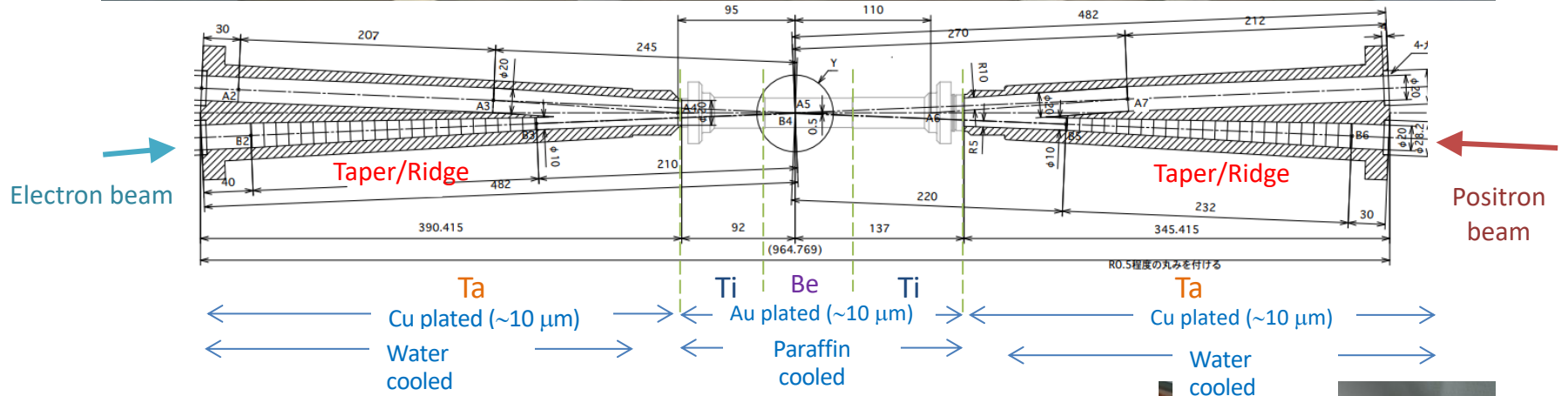
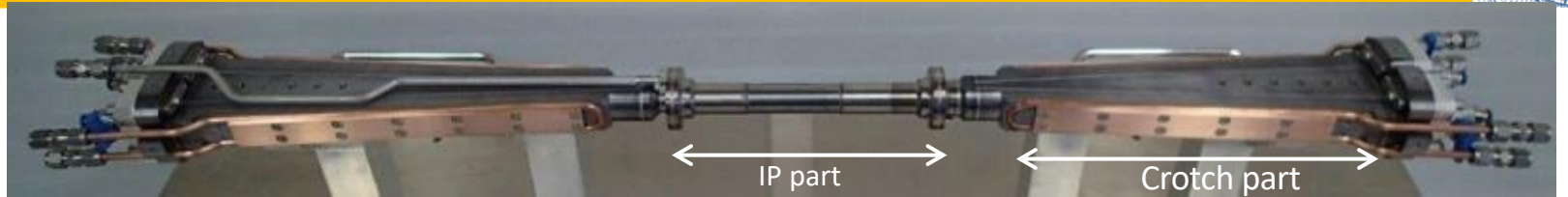
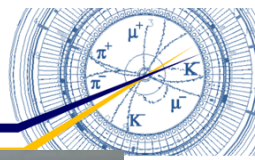

- Central IP part is made of Be and crotch parts are made of Ta.
- Ti (Titanium) is used to connect Be and Ta (tantalum).
- Only taper parts are exposed to direct SR from last bend.



A CAD model from Francesco Fransesini with special requirements for the heat load simulations using CST code

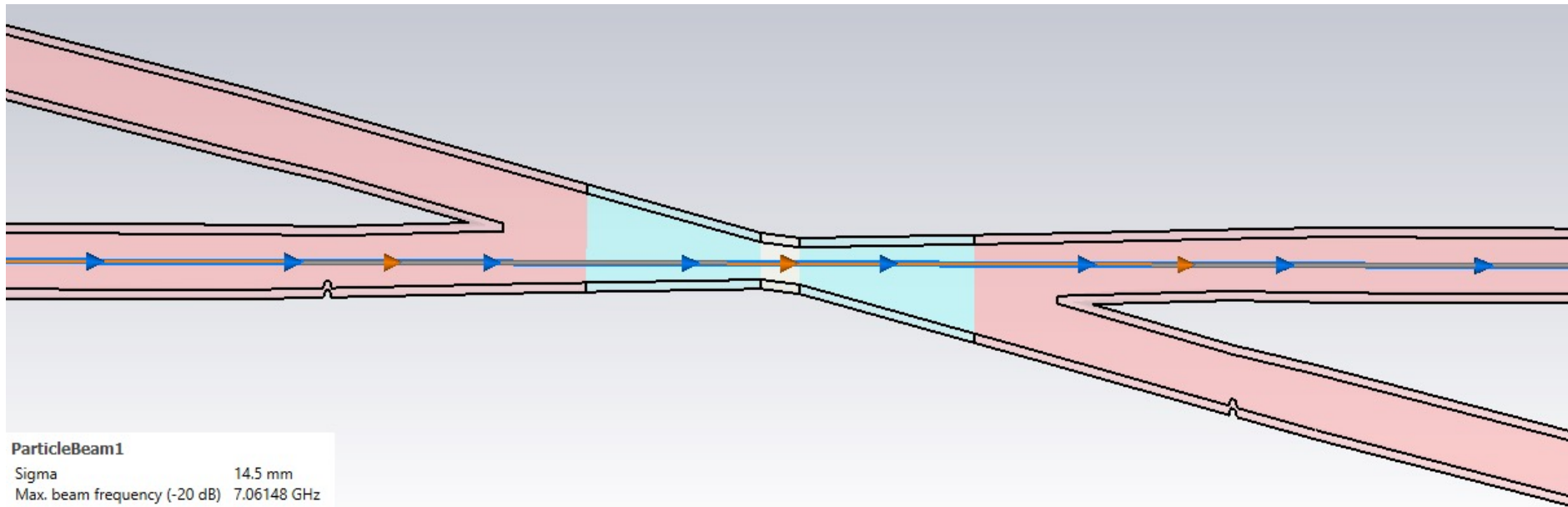

ParticleBeam1

Sigma	14.5 mm
Max. beam frequency (-20 dB)	7.06148 GHz
Beta	1
Charge	1e-09 C



Different materials: central Be part is coated with Gold

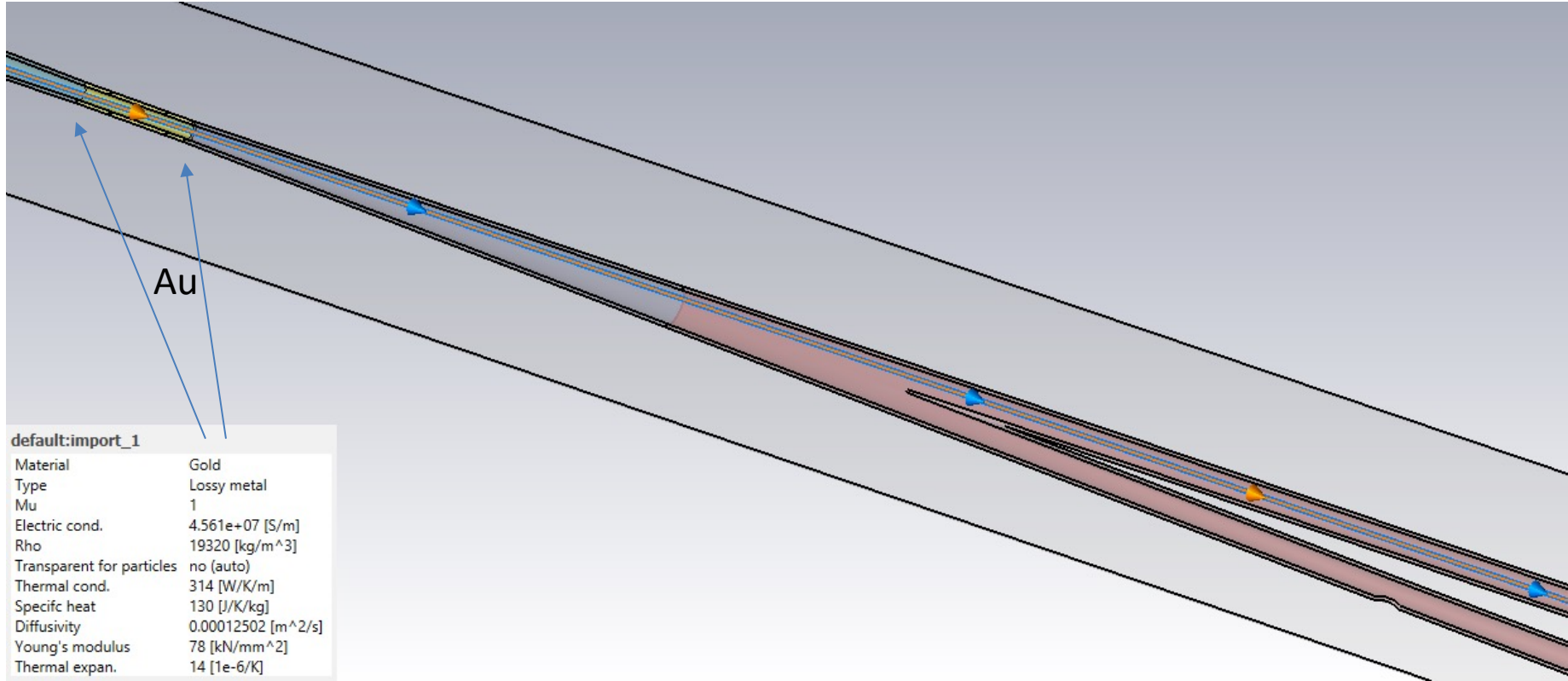

Be (AlBeMet) part

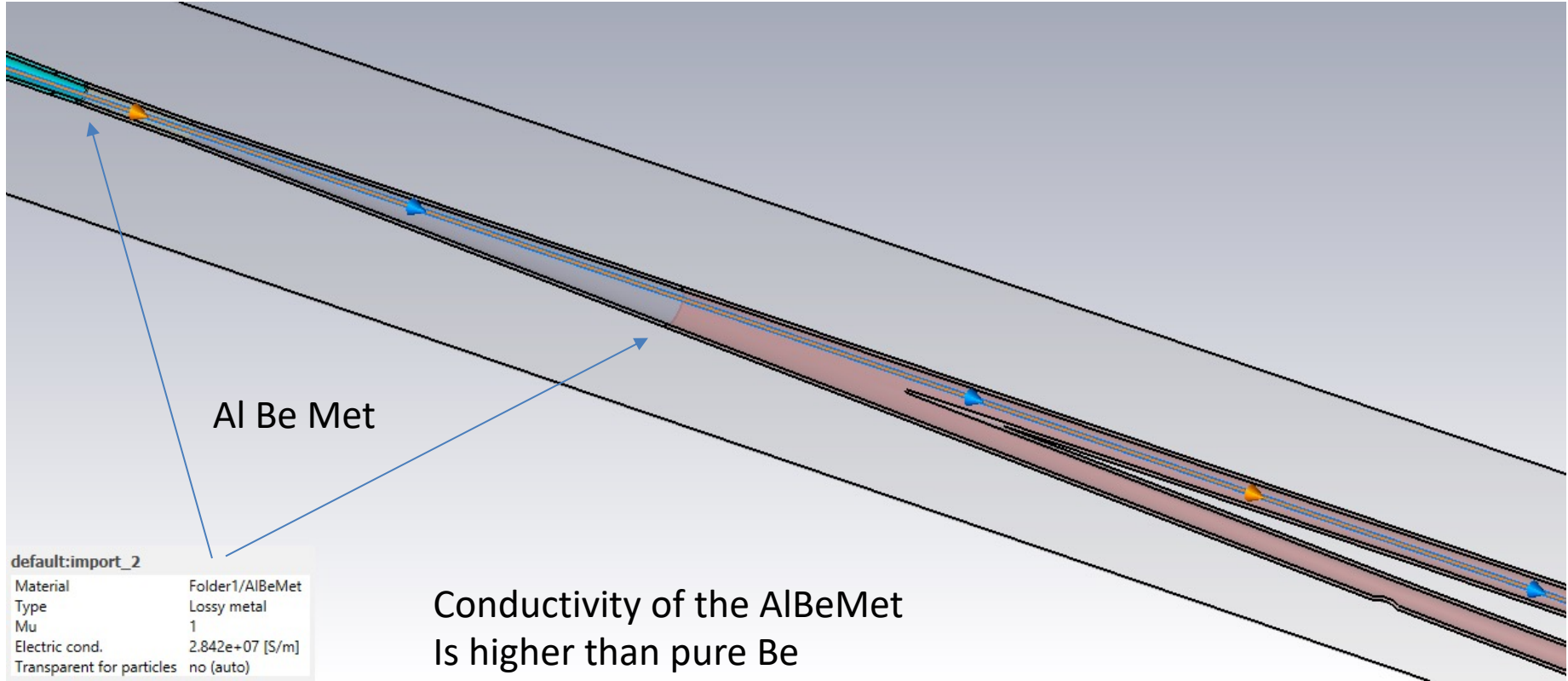

Cu part

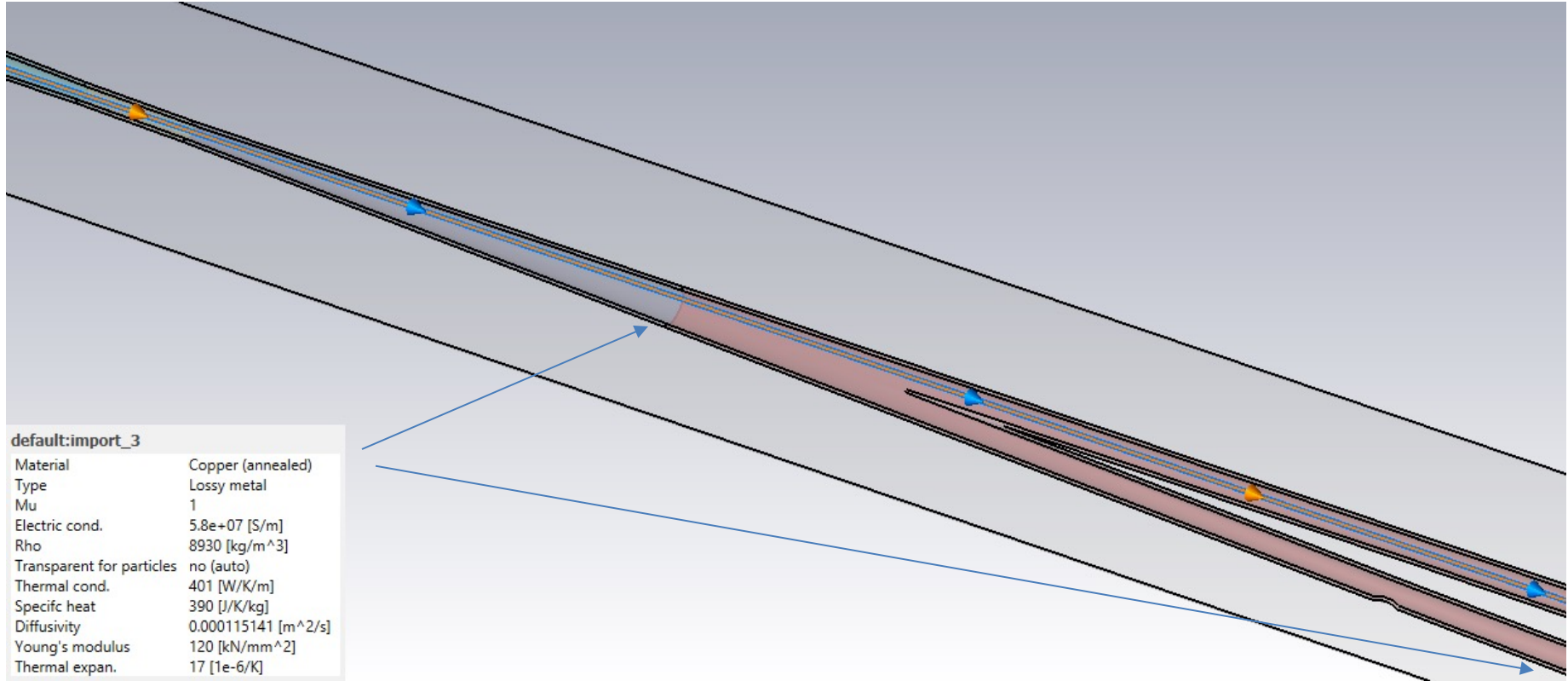

Comparison of the wake potentials (with/without materials)

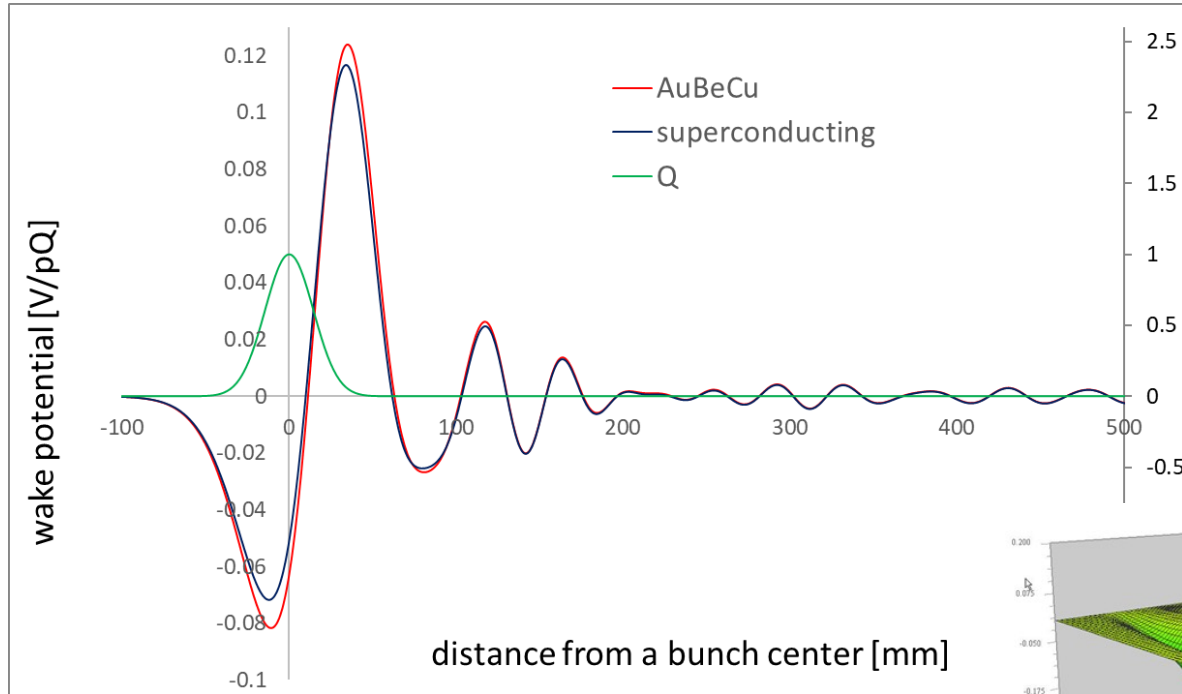

Loss factor
 with without
 0.0352 0.0265
 V/pC

Heat load
 with without
 3.69 2.78
 kW

In the IR walls
 910 W

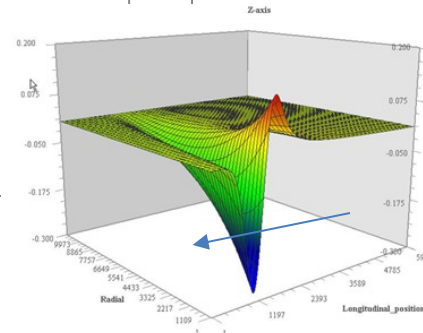
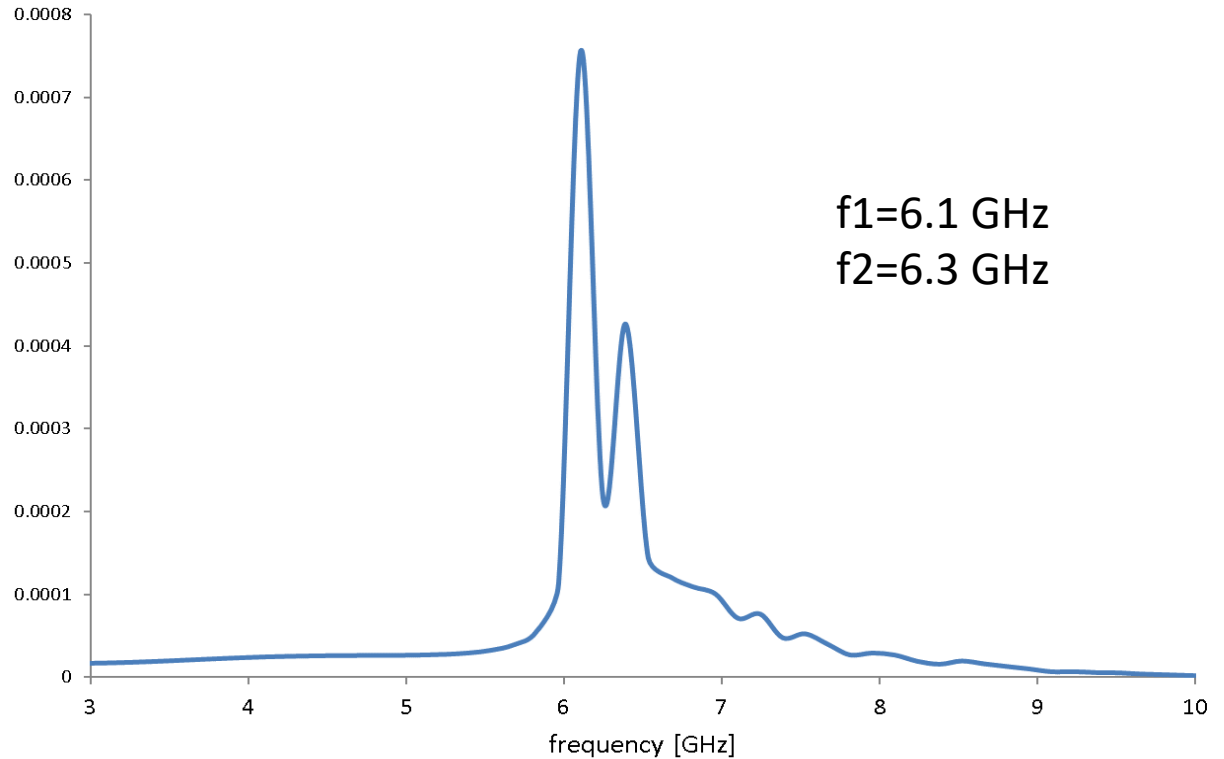
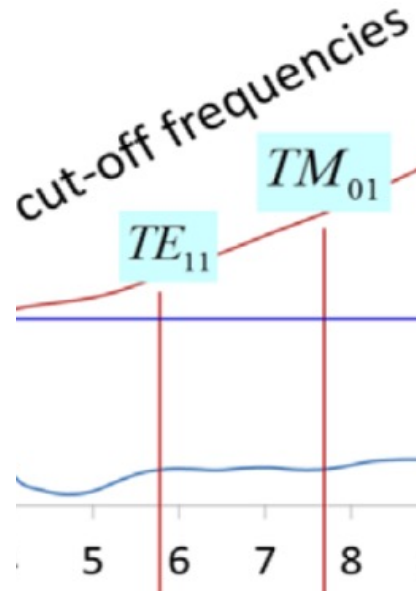

Image current fields follows the bunch



Still no strong trapped modes



Calculation of the heat load distribution

- To find the heat load in some part of IR, we do the following calculations:
 - At first, we do wake field calculations, assuming that all materials have infinite conductivity
 - Then we do wake field calculations, assuming that all materials have infinite conductivity, except the material of the interested part of IR
 - Finally, we take the difference
- Naturally, it needs a lot of calculations, but the result is important for the cooling system design.



Heat load distribution

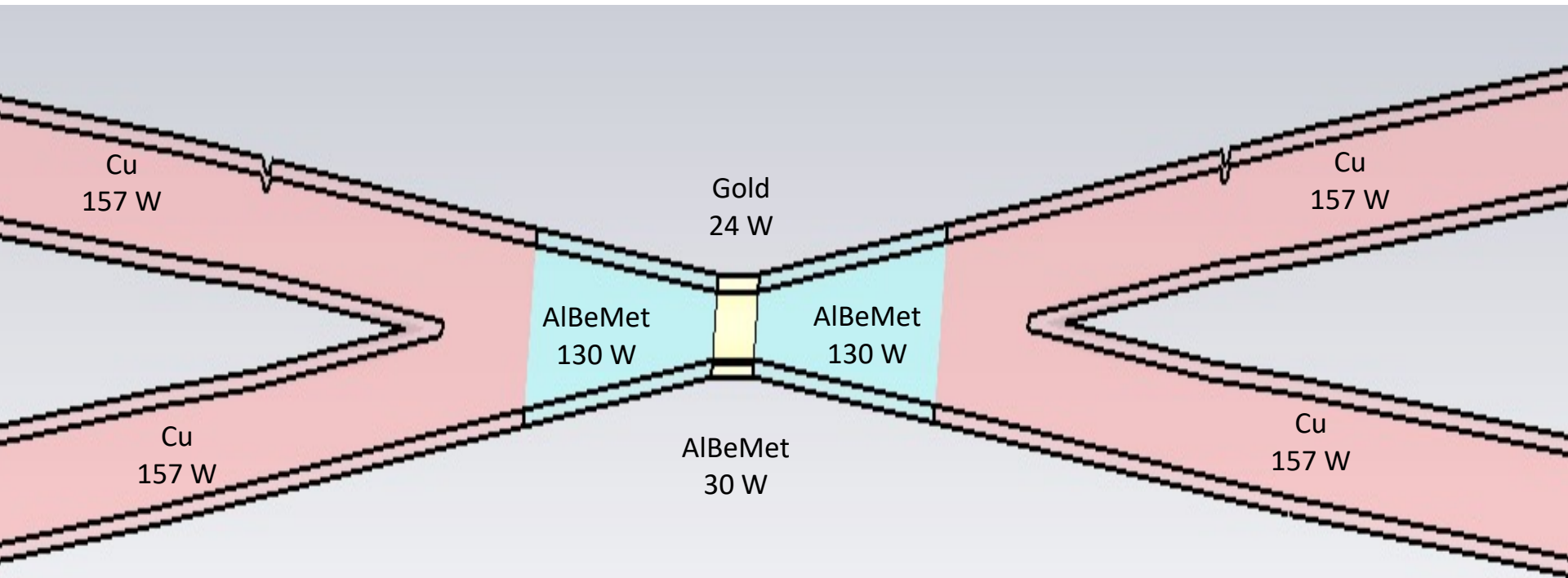

Scale is distorted



Heat load in the central part (180 mm) vs bunch length

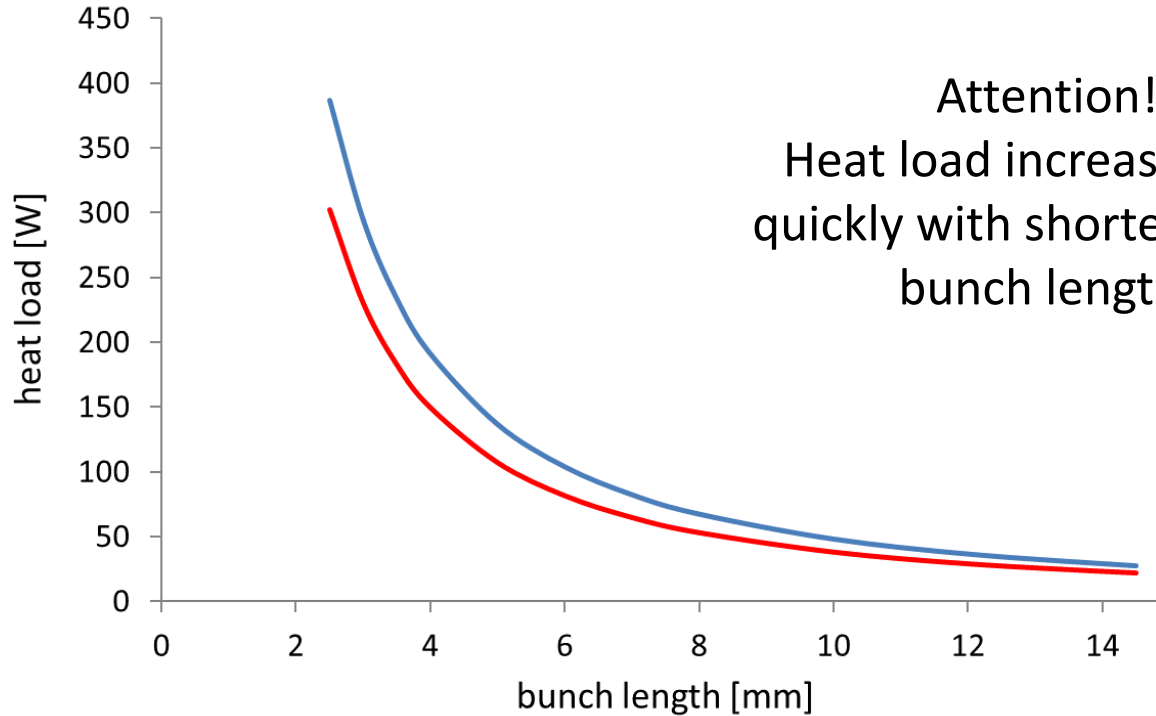

FCC-ee parameters

Parameter [4 IPs, 91.1 km, $T_{rev}=0.3$ ms]	Z	WW	H (ZH)	ttbar
beam energy [GeV]	45.6	80	120	182.5
beam current [mA]	1400	135	26.7	5.0
number bunches/beam	8800	1120	336	42
bunch intensity [10^{11}]	2.76	2.29	1.51	2.26
SR energy loss / turn [GeV]	0.0391	0.37	1.869	10.0
total RF voltage 400/800 MHz [GV]	0.120/0	1.0/0	2.1/0	2.5/8.8
long. damping time [turns]	1170	216	64.5	18.5
horizontal beta* [m]	0.15	0.2	0.3	1
vertical beta* [mm]	0.8	1	1	1.6
horizontal geometric emittance [nm]	0.71	2.17	0.64	1.49
vertical geom. emittance [pm]	1.42	4.34	1.29	2.98
horizontal rms IP spot size [μm]	10	21	14	39
vertical rms IP spot size [nm]	34	66	36	69
beam-beam parameter ξ_x / ξ_y	0.004/ 0.159	0.011/0.111	0.0187/0.129	0.096/0.138
rms bunch length with SR / BS [mm]	4.32 / 15.2	3.55 / 7.02	2.5 / 4.45	1.67 / 2.54
luminosity per IP [$10^{34} \text{ cm}^{-2}\text{s}^{-1}$]	181	17.3	7.2	1.25
tot. integr. luminosity / yr [ab^{-1}/yr]	86	8	3.4	0.6
beam lifetime rad Bhabha / BS [min]	19 / ?	20 / ?	10 / 19	12 / 46

For very new parameters

Heat load will go **up** by $(1400/1280)^2 * (1000/880) = 35\%$

Beam
current

Bunch
spacing

May be longer bunch length will help a little 14.5 \rightarrow 15.2. = -5%

Now heat load in central part will be **24 W * 1.3 = 31 W**

AlBeMet part **130 W * 1.3 = 169 W**

Each copper pipe **157 W * 1.3 = 204 W**



Conclusions

- Calculations showed that in the IR region (+-4 m) approximately 1 kW (now 1.3 kW) power is dissipated in the pipe walls
- Necessary cooling is needed
- Still no sings of the strong trapped modes because of the special shape of the IR chamber
- However almost 3 (4) kW power, which is generated in IR will go out in 4 pipes and will be dissipated somewhere in the rings.
- For the next steps it is very important to include all necessary details of the real IR chamber design in the CAD model.



Acknowledgement

We would like to thank Frank Zimmermann, and Michael Benedikt for their great support of this work.

I would like also to thank Timothy Maxwell and John Seeman for the real support of this activity from the SLAC side.

Many thanks to Oide Katsunobu, Michael Sullivan, Manuela Boscolo and MDI team for many useful discussions and help.

Thank you!

