

L-BAND RF GUN WITH A THERMIONIC CATHODE*

S. Nagaitsev[#], R. Andrews, M. Church, A. Lunin, O. Nezhevenko, N. Solyak, D. Sun, V. Yakovlev
 FNAL, Batavia, IL 60510, U.S.A.

Abstract

We present a conceptual design for an L-band (1.3 GHz) rf gun with a two-grid thermionic cathode assembly. The rf gun is designed to provide a 9 mA average beam current for 1 ms pulses at a 5 Hz rate. These parameters match the beam requirements for both the ILC and the Fermilab Project X test facilities. In our simulations we are able to attain a full bunch length of 20-30 degrees, while the output energy can vary from 2 to 4 MeV. Simulations as well as a preliminary design will be presented.

INTRODUCTION

A 750 MeV electron beam test facility at Fermilab is in the early construction phase [1]. This facility will eventually have an injector and 3 consecutive rf cryomodules powered by a single klystron in a configuration similar to that of the ILC and/or Project X. It will provide a systems test for the so-called “rf unit” for both high-level and low-level rf controls, including feed-back and feed-forward with beam loading.

In order to start the first tests of the system, a simple inexpensive thermionic gun is proposed instead of an rf photoinjector gun. The thermionic gun consists of a cathode-grid unit placed into a DESY-type 1/2 cell rf gun (Fig. 1) [2]. The gun design parameters are listed in Table 1.

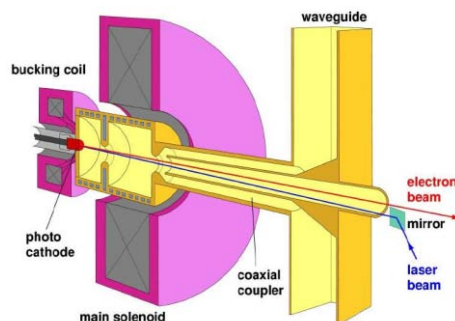

Figure 1: DESY rf gun layout. The photocathode is to be replaced by the thermionic cathode-grid unit.

Table 1: Thermionic gun design parameters

Operating frequency, GHz	1.3
Current, mA	9
Peak current, mA	200
Bunch length (95%), deg	30
Cathode diameter, mm	5
Peak cathode loading, A/cm ²	2.5-3

*Work supported by Fermi Research Alliance, LLC, under DE-AC02-07CH11359

[#]nsergei@fnal.gov

GENERAL

As shown in Fig. 2, the beam is injected directly into the rf cavity without preliminary acceleration and focusing. The cathode is separated from the rf cavity by two shadow grids, which shield the cathode from the rf field of the cavity and allow for operation of the gun as a Class C device. The cathode itself is insulated while both grids are grounded to the wall of the gun cavity. The cathode-grid unit is part of a coaxial resonator that is excited by a 200 W solid-state amplifier. In order to form short (~30°) bunches a dc bias voltage is applied to the cathode together with the rf voltage at 1.3 GHz. The control signals which form the bunch sequence are also applied to the cathode through the rf switch. The cathode-grid unit is shown in Figure 3.

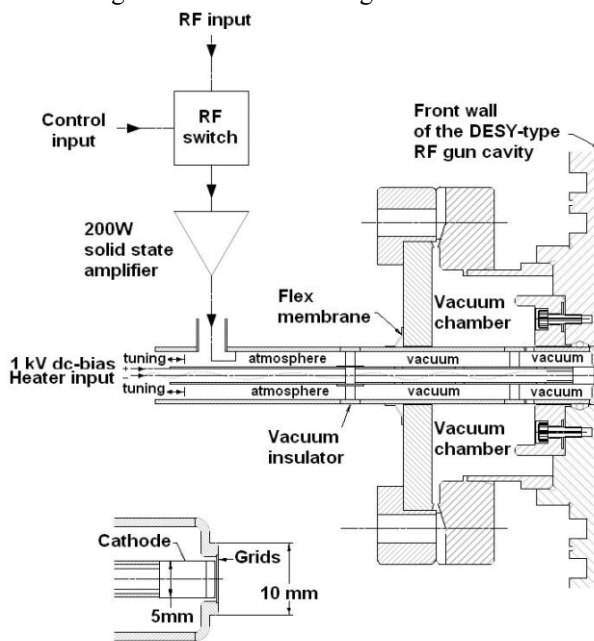

Figure 2: The thermionic gun cathode-grid unit assembly.

The distance between the cathode and the 1st grid should be small enough to provide a reasonable required input power while having sufficient mechanical strength. The grid cell diameter should be small enough to provide a reasonable beam transverse emittance.

The present design is based on a grid and cathode developed by HeatWave Labs [3]. The cathode diameter is 5 mm, the distance between the cathode and the 1st grid is 0.2 mm, the spacing of the grids is 0.4 mm, and the grid wire thickness 50 μm.

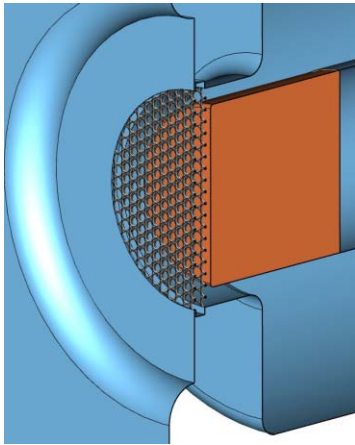

Figure 3: The cathode-grid design.

The required rf voltage U_0 may be estimated as

$$U_0 = \left(\frac{32\sqrt{2}d^2\bar{I}}{3\pi P_0 \varphi_0^4 R^2} \right)^{2/3},$$

where \bar{I} is the beam current averaged over an rf period, d is the cathode-grid gap, R is the cathode radius, φ_0 is the bunch half-width, and $P_0 = 2.4 \cdot 10^{-6} \text{ A} \cdot \text{V}^{-3/2}$. If the average current is 10 mA, the cathode radius is 2.5 mm, the gap is 0.2 mm, and the bunch width is 30° , then the required rf voltage amplitude is $\sim 900 \text{ V}$, and the required rf power is $\sim 55 \text{ W}$ (confirmed by more detailed simulations). In order to achieve the short bunch length, the magnitude of the dc bias voltage should be close to the amplitude of the rf voltage.

The accelerating rf field in the DESY-type rf gun cavity is nominally about 40 MV/m. A field enhancement factor of 2 yields 80 MV/m on the grid surface, which is too high in this application. In order to reduce the field to an acceptable level, it is suggested to deepen the grid by 1 mm with respect to the front cavity wall and reduce the gun accelerating rf field to $\sim 20 \text{ MV/m}$. In this case the maximal surface electric field is $\sim 48 \text{ MV/m}$. The rf field of the cavity penetrates into the input coaxial resonator, but the resulting amplitude of the field near the cathode does not exceed 5% of the field excited by the drive signal if the gap between the 1st and the 2nd grids is 0.4 mm. The signal in the coaxial resonator excited by the cavity field may be used as a diagnostic for the cavity field. The cavity field penetration into the cathode-grid gap is shown in Fig. 4a. The axial field near the cathode excited by the drive signal is shown in Fig. 4b.

The beam dynamics was simulated for one grid cell using the SMASON code [4]. This code performs 2D rf gun simulation for space-charge limited emission. The phase and amplitude of the input rf signal were optimized in order to achieve the minimal bunch length. The final parameters are shown in Table 2. Fig. 5 shows bunch charge as a function of rf phase. One can see that 95% of charge is within the phase range of 30° .

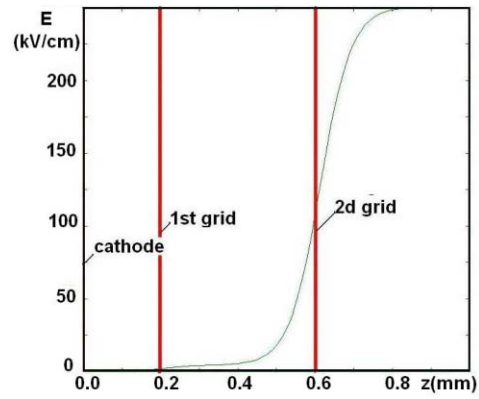

a) $U_{\text{cathode}}=0 \text{ V}$; gun rf field =25 MV/m

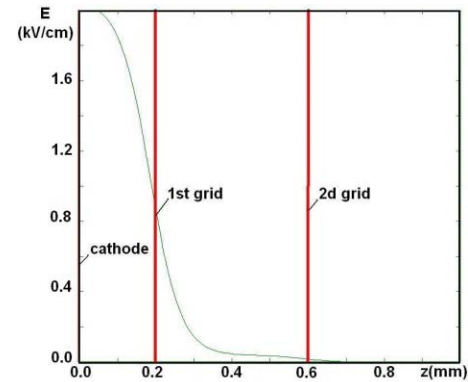

b) $U_{\text{cathode}}=40 \text{ V}$; gun rf field =0 MV/m

Figure 4: The on-axis field of the cathode-grid unit (a) penetration from the gun and (b) excited by the drive.

Table 2: Thermionic gun general parameters

dc voltage, V	800
rf voltage, V	870
current, mA	9
bunch length (95%), deg	30
output energy, MeV	2.5
r.m.s energy spread at the gun output, %	7
r.m.s. emittance (norm, rms), μm	20

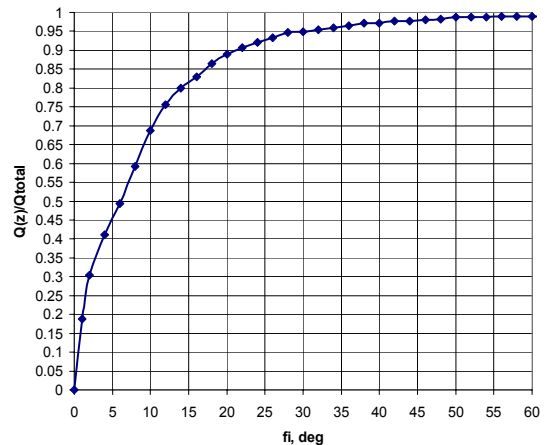

Figure 5: Bunch charge vs. rf phase.

BEAM DYNAMICS IN THE LINAC

Fig. 6 shows the proposed beamline layout from the exit of the rf gun to the entrance of the 1st ILC-type rf cryomodule. The beam energy at the exit of the rf gun is ~2.5 MeV, and it is required to accelerate this to ~20 MeV before injecting into the rf cryomodules in order to avoid severe over-focusing in the rf cavities. This is accomplished with a 1.3 GHz 9-cell rf cavity operating at an accelerating gradient of ~20 MV/m (CC in Fig. 6) [5].

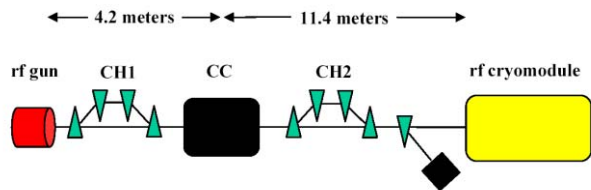

Figure 6: Beamline layout from rf gun to 1st rf cryomodule

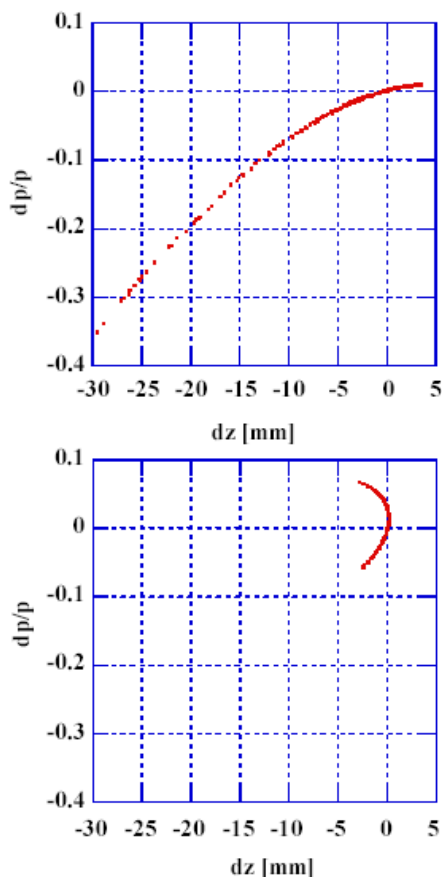

Figure 7: Longitudinal phase space. Top plot is at exit of rf gun; bottom plot is at entrance to 1st rf cryomodule.

It is also required to substantially narrow the bunch length so that the beam can be accelerated off-crest in the rf cavities without introducing excessive momentum spread in the high energy end of the linac. This is accomplished in two parts. First, two momentum collimators placed in dispersive regions of the first 4-

magnet chicane (CH1 in Fig. 5) remove the low energy beam tail (~25% of the beam). The remainder of the bunch narrowing is accomplished by bunch rotation in longitudinal phase space using CC (operating ~25° off-crest) and the 2nd 4-magnet chicane (CH2 in Fig. 6). Plots of longitudinal phase space at the exit of the rf gun and at the entrance to the rf cryomodules are shown in Fig. 7. Tracking simulations were performed using OptiM [6].

CONCLUSIONS

The proposed thermionic rf gun with an internal injection system presents an economical alternative to a photo-cathode based rf gun for beam tests where beam emittance is not of paramount importance. The cathode-grid assembly is designed to be plug-compatible with an existing photo-cathode assembly and can be later upgraded to a photo-cathode, if needed. To reduce the bunch length we propose to use a two-stage bunch compression and collimation systems. The beam parameters after compression allow for an acceleration at up to 30-degrees off-crest in the cryomodules. Finally, the proposed cathode assembly can be used as an rf probe for the gun cavity. At present, the existing DESY-type rf gun cavity lacks such a probe.

ACKNOWLEDGEMENTS

The authors thank Dr. D. Myakishev for the code SMASON improvements necessary for the rf gun simulations.

REFERENCES

- [1] M. Church, S. Nagaitsev, F. Piot, "Plans for a 750 MeV Electron Beam Test Facility at Fermilab," PAC'07, THPMN099; <http://www.JACoW.org>
- [2] M. Ferrario et al., Conceptual Design of XFEL Photoinjector, TESLA-FEL Report 2001-03.
- [3] HeatWave Labs, <http://www.cathode.com/>
- [4] A.V. Grudiev, D.G. Myakishev, V.P. Yakovlev, S. Luetgert, S. Krueger, "Numerical Simulation of a Gridded Inductive Output Amplifier", Proceedings of the 1996 European Particle Accelerator Conference (EPAC'96), Barcelona, June 1996, pp. 1244-1246.
- [5] J. Branlard, et al, "Capture Cavity II Results at FNAL", PAC'07, WEPMN092; <http://www.JACoW.org>
- [6] V. Lebedev, <http://www-bdnew.fnal.gov/pbar/organizationalchart/lebedev/OptiM/optim.htm>