

# FIRST BEAM TESTS FOR THE PROTOTYPE LHC ORBIT AND TRAJECTORY SYSTEM IN THE CERN-SPS

D. Cocq, L. Jensen, R. Jones, J.J. Savioz, CERN, Geneva, Switzerland  
 D. Bishop, B. Roberts, G. Waters, TRIUMF, Vancouver, Canada

## Abstract

The first beam tests for the prototype LHC orbit and trajectory system were performed during the year 2000 in the CERN-SPS. The system is composed of a wide-band time normaliser, which converts the analogue pick-up signals into a 10 bit position at 40MHz, and a digital acquisition board, which is used to process and store the relevant data. This paper describes the hardware involved and presents the results of the first tests with beam.

## 1 INTRODUCTION

The LHC Orbit and trajectory prototype system is divided into two parts; an analogue front-end module (WBTN) that processes the signal from the four-button pick-up to produce digitised position data at 40MHz and a Digital Acquisition Board (DAB) that selects, stores and pre-processes the position data. The DAB module is developed at TRIUMF (Vancouver, Canada) using CERN specifications as part of the Canadian contribution to the LHC whereas the WBTN is developed entirely at CERN. An overview of the whole system is shown in Fig. 1. The initial signal is provided by a button pick-up, which is then processed by a wide-band time normaliser, converting the beam position into a pulse modulation at 40MHz. A 10-bit ADC then digitises this signal before a digital acquisition board is used to sort and store the data in memory.

## 2 WIDE BAND TIME NORMALISER

The principle of the Wide-Band Time Normaliser (WBTN) is explained in [1]. The WBTN is used to convert the amplitude ratios of the two signals provided by a pair of electrodes, into a variation in time. In this application an excursion over the full aperture of the BPM corresponds to a pulse width modulation of  $\sim 3\text{ns}$ . This variation is measured with an integrator and digitised with a 10-bit ADC at 40MHz. Within a dynamic range in intensity of 40dB, the systematic error measured at the centre is less than 1% (see Fig. 2). This covers the foreseen operating bunch intensities of the LHC, from the pilot bunch at  $5 \times 10^9$  protons per bunch to the ultimate  $1.7 \times 10^{11}$  protons per bunch. As the system works at 40MHz, measuring each individual bunch, there is no need to take into account the filling pattern when considering the dynamic range. The RMS random error due to noise remains well below 1% for the nominal and ultimate bunch intensities, rising to 1.3% for the pilot bunch, as can be seen in Fig. 3. The measured position is corrected using a 3<sup>rd</sup> order polynomial following the theory outlined in [1]. The systematic error can thereby be reduced to around 1% (see Fig. 4).

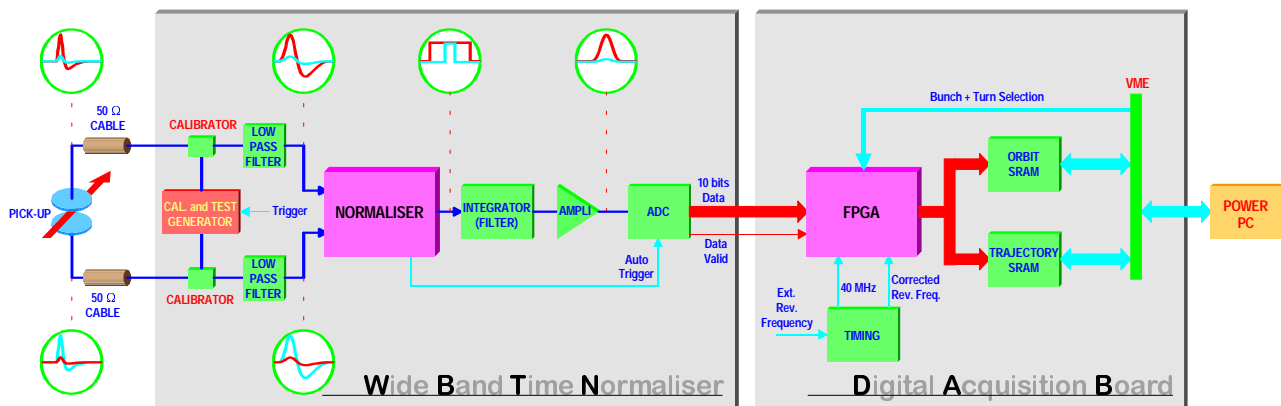

Figure 1: Schematic of the prototype LHC beam position system installed in the CERN-SPS

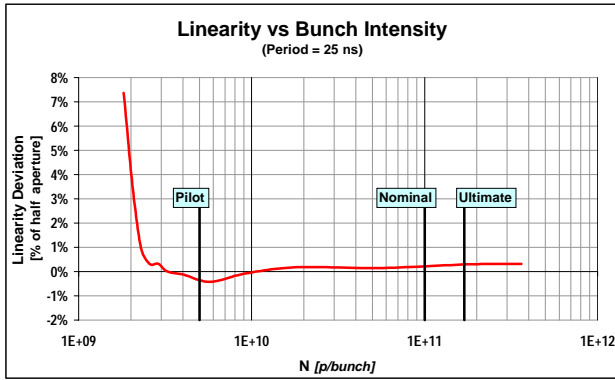

Figure 2: WBTN linearity as a function of intensity.

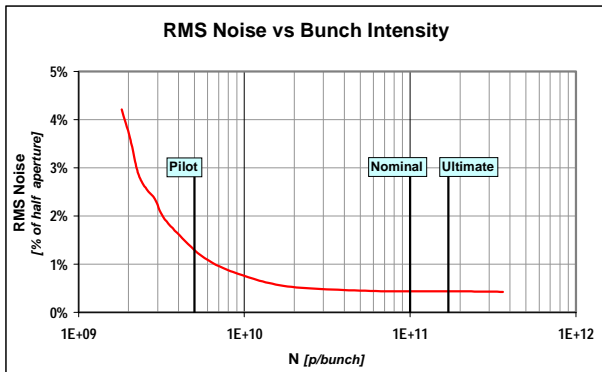

Figure 3: WBTN RMS noise as a function of intensity.

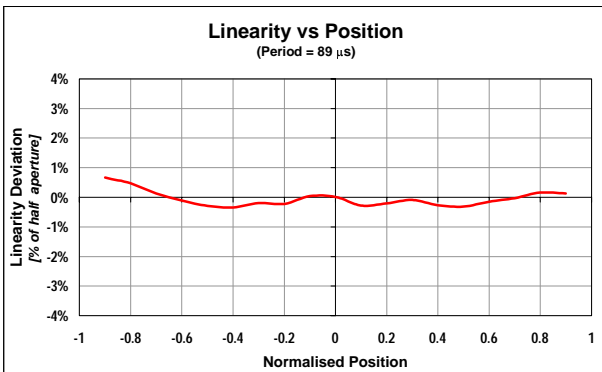

Figure 4: WBTN Linearity as a function of position.

### 3 DIGITAL ACQUISITION BOARD

The Digital Acquisition Board (DAB) is responsible for selecting, storing and pre-processing the position information that is provided by the WBTN. In the first generation of the DAB module, that became available during the summer of 2000, only the capture (random) acquisition mode was implemented. This allows  $N$  bunches to be acquired over  $T$  consecutive turns where  $N \times T \leq 64000$ . This number comes from the available memory on the DAB module. In future versions, an orbit acquisition mode will be added, which will be capable of providing real-time closed orbit measurements at 10Hz.

Two Altera FPGAs handle the intelligence on the DAB module: one for the bunch selection and storage, the other for the VME access to registers and memory. An on-board low-jitter PLL circuit creates the 40MHz bunch-clock from the 44kHz SPS revolution frequency, and is used to handle the synchronisation with the WBTN. A dedicated bus had been specified on the VME P2 bus to transfer the ADC values and status bits to from the WBTN to the DAB module.

### 4 INITIAL TESTS

The prototype WBTN module contains a generator that can be controlled from the DAB module. This generator will be used for calibrating the measurement chain by setting values on the WBTN output that correspond to the two extreme positions (left/right or up/down) and the centre of the BPM. With a 10-bit unipolar ADC the values we expect are between 0 and 1023. In Fig. 5 one can see the distribution of ADC values in calibration mode, before correction, for a centred beam with a signal strength equivalent to an intensity of  $5 \times 10^{10}$  protons per bunch. This was recorded by the DAB after the complete chain of acquisition electronics. The distribution sigma of 2 bins corresponds to an RMS noise of  $40 \mu\text{m}$  for the 83mm diameter BPM that was used for the measurements in the SPS.

Distribution of ADC values for WBTN calibration (mean = 473, sigma = 2)

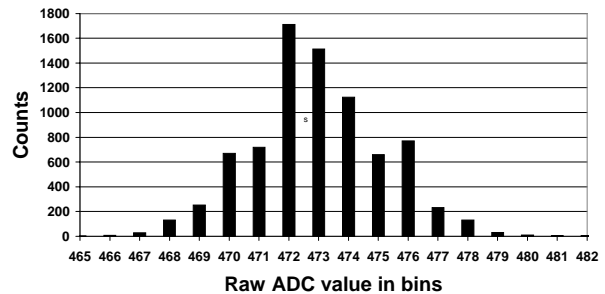

Figure 5: Distribution of ADC values after the complete acquisition chain.

### 5 MEASUREMENTS ON THE BEAM

The system linearity was measured using local orbit bumps and comparing the results obtained with calibrated readings from the existing CERN-SPS MOPOS orbit acquisition system. Good agreement, even without non-linear correction, can be seen in Fig. 6, for orbit deviations representing up to 15% of the BPM half-aperture.

The capabilities of the prototype system allowed several interesting machine development studies to be performed. A typical result from an LHC batch (72 bunches spaced by 25ns) affected by instabilities is shown in Fig. 7 for four selected bunches. The first bunch in the

batch is seen to be stable, while later are affected by the electron cloud phenomenon [2], giving rise to transverse instabilities. The re-stabilisation of these bunches further along in the cycle can be explained by the decrease in their intensity due to beam loss.

Another experiment that profited from the capabilities of the prototype LHC beam position measurement system concerned so-called “AC-Dipole” excitation. This, in principle, allows the excitation of transverse oscillations to large (several  $\sigma$ ) excursions without emittance blow-up. The idea was originally proposed and tested at BNL for resonance crossing with polarised beams, using an orbit corrector dipole with an excitation frequency close to the betatron tune, hence the term “AC-Dipole”. This technique was tested in the SPS using the transverse damper as an “AC-Dipole” providing the fixed frequency excitation [3]. Fig. 8 shows the beam response, measured with the prototype LHC beam position measurement system for a single bunch over 22000 turns. A single, one-turn, Q-kick excitation for measuring the tune is also visible at then end of the excitation.

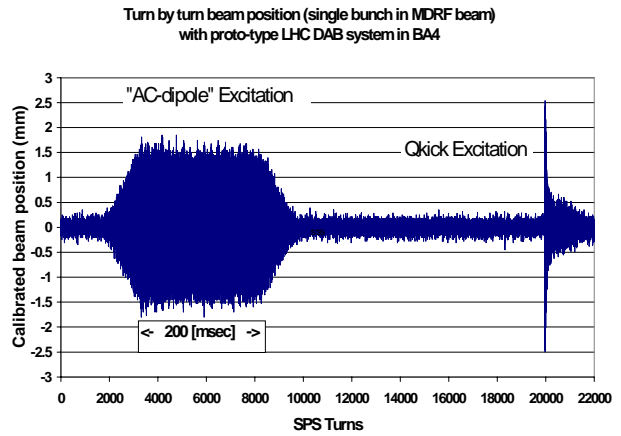

Figure 8: The investigation of “AC-Dipole” excitation.

Linearity test for DAB system (MDRF beam)

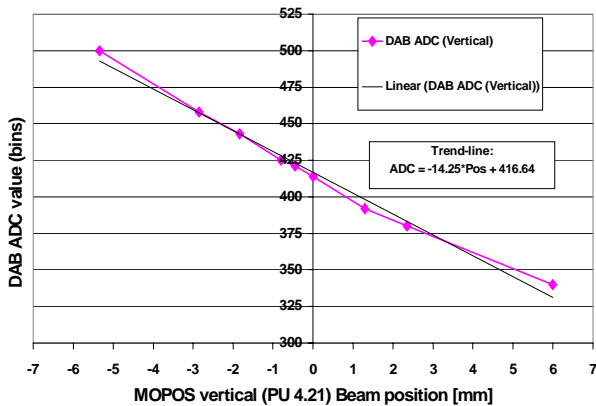

Figure 6: Linearity comparison with SPS closed orbit acquisition system (MOPOS).

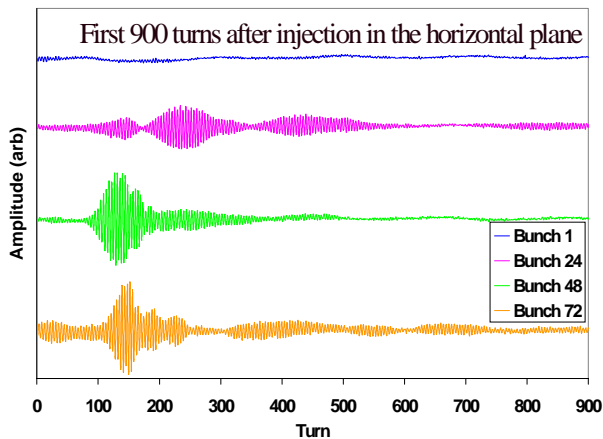

Figure 7: Observation of an instability caused by the electron cloud phenomenon using the prototype LHC beam position measurement system.

## 6 CONCLUSIONS

Installing a prototype LHC beam position measurement system in the CERN-SPS has proved very useful for testing the two main components of the final LHC Orbit acquisition system, namely the wide band time normaliser and the digital acquisition board. The auto-trigger mechanism of the WBTN and the flexibility of the DAB module have also meant that this prototype became an important tool during machine studies. To this end a dedicated SPS system based on the same acquisition electronics will be installed in the CERN-SPS in the near future.

## 7 REFERENCES

- [1] D. Cocq, “The Wide Band Normaliser : a New Circuit to Measure Transverse Bunch Position in Accelerators and Colliders”, Nucl. Instrum. Methods Phys. Res., A 416, 1998.
- [2] G. Arduini, "Observations in the SPS: Beam Emittance, Instabilities", Proceedings of the Workshop on LEP-SPS Performance - Chamonix XI, Chamonix, January 2001, CERN-SL-2001-003 DI.
- [3] O. Berrig, W. Hofle, R. Jones, J. Koopman, J-P Koutchouk, F. Schmidt, “Emittance-Conserving Transverse Excitation using the ‘AC-Dipole’ Principle”, SL-Note-2000-062 MD, 2000.