

# HIRFL STATUS AND HIRFL-CSR PROJECT IN LANZHOU

J. W. Xia, Y. F. Wang, Y. N. Rao, Y. J. Yuan, M. T. Song, W. Z. Zhang, P. Yuan, W. Gu,  
X. T. Yang, X. D. Yang, S. L. Liu, H.W.Zhao, J.Y.Tang, W. L. Zhan, B. W. Wei

Institute of Modern Physics, Chinese Academy of Sciences  
P.O. Box 31, Lanzhou, 730000, P.R. China

Y. Yano, A. Goto

Institute of Physical and Chemical Research (RIKEN), Wako, Saitama 351-01, Japan

T. Katayama, S. Watanabe

Institute for Nuclear Study, University of Tokyo, Tanashi, Tokyo 188, Japan

## Abstract

HIRFL-CSR, a new accelerator project planned at the Heavy Ion Research Facility in Lanzhou (HIRFL), is a multipurpose Cooling Storage Ring system which consists of a main ring (CSRm) and an experimental ring (CSRe). The two existing cyclotrons SFC (K=69) and SSC (K=450) of the HIRFL will be used as its injector system. The heavy ion beams from the HIRFL will be accumulated, cooled and accelerated in the main ring, and then extracted to produce radioactive ion beams (RIB) or highly charged heavy ions. The secondary beams (RIB or highly charged ions) can then be accepted by the experimental ring for internal-target experiments. In this paper the status of the HIRFL and the details of the HIRFL-CSR project will be reported.

## 1 HIRFL STATUS

The Heavy Ion Research Facility in Lanzhou (HIRFL) [1], shown in Figure 2, has been operated for ten years for the heavy ion physics and applications in the intermediate energy domain. More than 40 species of ion beam up to  $^{129}\text{Xe}^{18+}$  have been provided for the physical experiments. Recently the construction of the Radioactive Ion Beam Line in Lanzhou (RIBLL) has been finished. The details of it is reported by another paper of this conference [2]. Several improvements of the HIRFL have been done in order to improve the performance [3]. They are the construction of a new 14.5 GHz ECR ion source, the construction of the new ECR beam line and the upgrading of the control system of the HIRFL.

### 1.1 14.5 GHz ECR Ion Source

A new 14.5 GHz ECR ion source, shown in figure 1, was constructed in 1997. For this source the high axial magnetic field (field peak 1.5 Tesla) and radial hexapole field (1.0 Tesla on the chamber wall) can be reached. A long plasma chamber with the effective length 300mm

and double wall was designed to increase plasma volume. Two kinds of configuration, one is the coaxial line, another one is the rectangular wave guide, were considered respectively so that two microwave frequency heating could be tested. The preliminary results obtained on the test bench with the single frequency of 14.5 GHz are shown in Table 1.

Table 1 Test results of the 14.5 GHz ECR Ion Source

Ion	O <sup>6+</sup>	O <sup>7+</sup>	Ar <sup>8+</sup>	Ar <sup>11+</sup>	Ar <sup>12+</sup>
Intensity(μA)	520	100	460	155	55

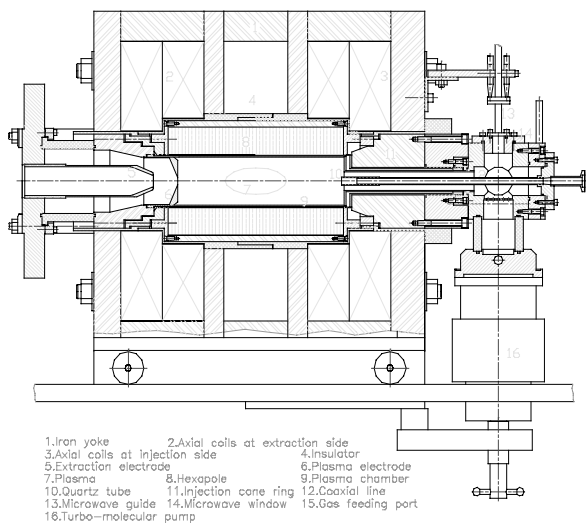

Figure 1 14.5 GHz ECR ion source

### 1.2 New ECR Beam Line

A new beam line from the ECR ion source to the cyclotron SFC was constructed to replace the old one. Two ECR ion sources were installed on the new beam line symmetrically. This make it possible to switch on from one source to another conveniently. In the new line

a new analysis magnet with the bend angle of  $90^\circ$  was used to get the higher charged-state resolution.

### 1.3 Upgrading of the Control System

The old VAX/8350 computer system can't satisfy the present requirement of the HIRFL operation. Recently a new control system which consists of some high-level micro computers, workstations and so on has been finished, and used for the beam tuning and the machine operation since November of 1997.

## 2 HIRFL-CSR PROJECT

### 2.1 Outline

CSR [4,5,6], a multifunctional Cooling Storage Ring (CSR) system shown in Figure 2, is planned to upgrade the HIRFL to form a more powerful HIRFL-CSR accelerator system. It consists of a main ring (CSRm) and an experimental ring (CSRe). The heavy ion beams with the energy range of 10~50 MeV/u from the HIRFL will be accumulated, cooled and accelerated to the high energy range of 100~400 MeV/u in the main ring (CSRm), and then extracted fast to produce radioactive ion beams (RIB) or highly charged heavy ions. The secondary beams (RIB or highly charged heavy ions) can be accepted by the experimental ring (CSRe) for many

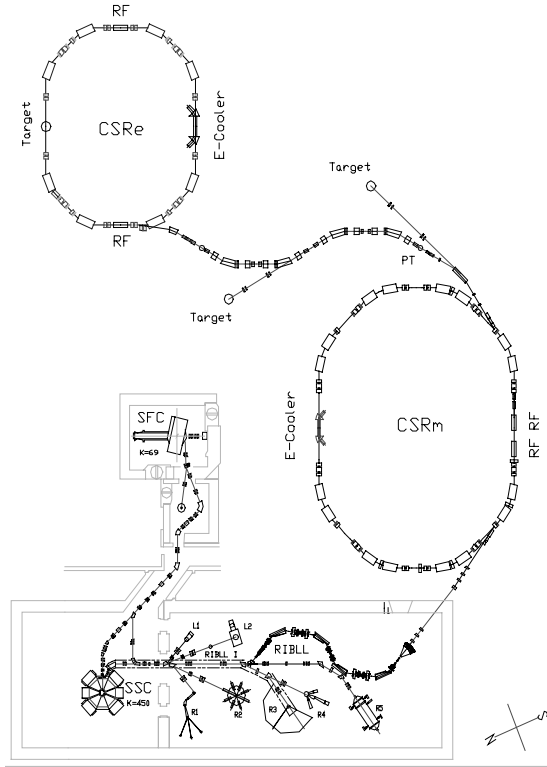

Figure 2: The overall layout of the HIRFL-CSR

internal-target experiments or high precision spectroscopy with beam cooling. On the other hand the beams with the energy range of 400~900MeV/u will also be provided by the CSRm while using slow extraction or fast extraction for many external-target experiments.

### 2.2 Basic Parameters

The main accelerator parameters of the CSR system are listed in Table 2, Table 3 is the beam parameters of it.

Table 2: Main parameters of the CSR

	CSRm	CSRe	
Circumference (m)	161.20	120.90	
Geometry	Race-track	Race-track	
Energy (MeV/u)	25--900 ( $C^{6+}$ ) 10--400 ( $U^{72+}$ )	30--400 ( $C^{6+}$ ) 30--250 ( $U^{90+}$ )	
$B\rho_{\min}/B\rho_{\max}$ (Tm)	1.40/10.64	1.50/6.44	
Ramping rate (Tm/s)	~ 3.0	~ 2.5	
Repeating Circle (s)	~ 17 (10s for Accumulation)		
Acceptance	With error	Pure	
$A_h$ ( $\pi$ mm-mrad)	200	470 ( $\Delta P/P=0$ )	
$A_v$ ( $\pi$ mm-mrad)	20	170	
$\Delta P/P$ (%)	$\pm 0.15$	$\pm 3.5$ ( $\epsilon_h=0$ )	
E-cooler			
$E_{ion}$ (MeV/u)	10--50	30--300	
Length (m)	4.0	3.5	
RF system	Accel.	Accum.	Capture
Harmonic number	2	16, 32	1
$f_{\min}/f_{\max}$ (MHz)	0.5/3.3	6/14	0.6/1.8
Voltages (n×kV)	1×7	1×20	2×15
Vacuum (mbar)	$2 \times 10^{-11}$	$2 \times 10^{-11}$	

Table 3 Beam parameters of the CSR

	Emittance ( $\pi$ mm-mrad)		$\pm \Delta P/P$	Bunches /turn	Intensity (pps)
	$\epsilon_h$	$\epsilon_v$			
From HIRFL	10	10	$1.5 \times 10^{-3}$	16, 32	$10^{12-9}$
Multiturn inj. in CSRm	150	20	$1.5 \times 10^{-3}$	Coasting	$10^{14-12}$
Cooling down in CSRm	30	5	$2.0 \times 10^{-4}$	2	$10^{14-12}$
Extraction from CSRm	5	1	$5.0 \times 10^{-4}$	1	$10^{8-6}$
RIB accepted by CSRe	20	20	$5.0 \times 10^{-3}$	1	$10^{12-7}$

### 2.3 Beam Accumulation of the CSRm

Two methods will be used for the beam accumulation in the CSRm. One is the multiple multiturn injection with the horizontal acceptance of  $150 \pi$  mm-mrad, and the repeating circle is decided by the cooling time of the beam phase space from  $150 \pi$  mm-mrad to  $30 \pi$  mm-mrad. Another one is the combination of the multiturn injection and RF stacking with the horizontal acceptance of  $50 \pi$  mm-mrad and the longitudinal acceptance of  $\Delta p/p = 0.75 \%$ , the accumulation repeating circle is decided by the RF stacking time. For the two accumulation methods electron cooling will be used simultaneously for the compressing of beam phase space in order to increase the accumulation ratio and efficiency. Figure 3 and Figure 4 are the e-cooling simulation results for the two beams of  $^{12}\text{C}^{6+}$  and  $^{238}\text{U}^{72+}$  with the initial horizontal emittance of  $\epsilon_h = 150 \pi$  mm-mrad, and the initial momentum spread of  $\Delta p/p = \pm 0.15 \%$ .

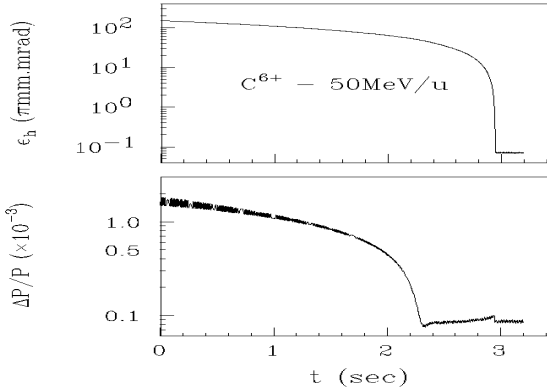

Figure 3: E-cooling for the beam of  $^{12}\text{C}^{6+}$

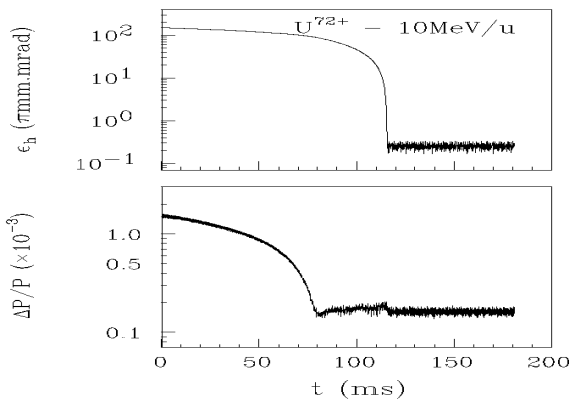

Figure 4: E-cooling for the beam of  $^{238}\text{U}^{72+}$

Table 4 is the accumulation parameters of three typical ions for the two methods. Comparing with the method of the multiple multiturn is faster than the combination of multiturn and RF stacking for those very heavy ion

beams, but for those light heavy ion beams it is just contrary.

Table 4. Parameters of the accumulation in the CSRm

	$^{12}\text{C}^{6+}$	$^{129}\text{Xe}^{48+}$	$^{238}\text{U}^{72+}$
Energy (MeV/u)	50	20	10
Current (pps)	$3.1 \times 10^{12}$	$1.2 \times 10^{10}$	$8.2 \times 10^9$
Accum. period (s)	10	10	10
Multiturn injection ( $150 \pi$ mm-mrad )			
Repeating cycle(ms)	2505	246	106
Particles of accum.	$1.0 \times 10^8$	$1.2 \times 10^7$	$2.0 \times 10^6$
Multiturn injection ( $50 \pi$ mm-mrad )+RF stacking ( 0.75 % )			
Repeating cycle(ms)	50	30	30
Particles of accum.	$1.5 \times 10^9$	$1.8 \times 10^7$	$1.1 \times 10^6$

### 2.4 CSRm Design

#### 2.4.1 CSRm lattice

The CSRm is a race-track shape and consists of four identical arc sections shown in Figure 5. Each arc section is a dispersion suppressor consisting of four dipoles, two triplets and one doublet. 8 independent variables for quadrupole are used in the CSRm. The lattice of each arc section is given as follows:

$$\text{-----} L_1 \text{-----} \text{FDF--B--B--F} \text{-----} L_2 \text{-----} \text{DF--B--B--DF} \text{-----}$$

where  $2L_1$  is a long-straight section with dispersion free for e-cooler or RF cavities.  $L_2$  is a dispersion drift for beam injection or extraction. Table 5 is the linear lattice parameters of the CSRm.

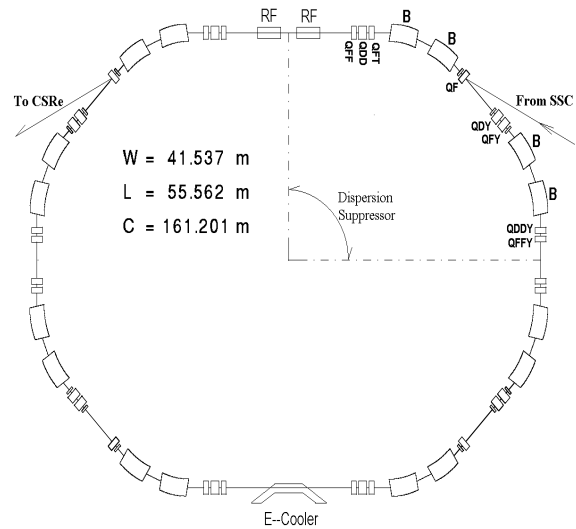

Figure 5 Magnetic-focus structure of the CSRm

Table 5: Lattice parameters of the CSRm

Transition gamma	$\gamma_{tr} = 4.76$
Betatron tune values	$Q_x / Q_y = 3.58 / 2.54$
Natural chromaticity	$Q'_x / Q'_y = -3.53 / -3.17$
Max. $\beta$ -amplitude	$\beta_x/\beta_y = 12.9/14.0$ m (Dipole) $\beta_x/\beta_y = 18.4/31.3$ m (Quadrupole)
Max. dispersion	$D_{max}(x) = 3.0$ m (Dipole) $D_{max}(x) = 4.2$ m (Quadrupole)
Injection section	$\beta_x = 5.4$ m, $D_x = 4.1$ m (Septum) $\beta_x = 6.4$ m, $D_x = 4.2$ m (Quadr.) $\beta_x = 5.3$ m, $D_x = 3.0$ m (Dipole)
E-cooler section	$\beta_x/\beta_y = 6.7/16.2$ m, $D_x = 0$
RF station section	$\beta_x/\beta_y = 18.2/2.2$ m, $D_x = 0$

### 2.4.2 Beam injection and extraction of the CSRm

One electric-static septum (ES) and two magnetic septums (MS1, MS2) will be used to deflect the beam into the ring, and four bump magnets (B1, B2, B3, B4) will be used for making the central orbit of the ring as a convex orbit in the injection section so that the injected

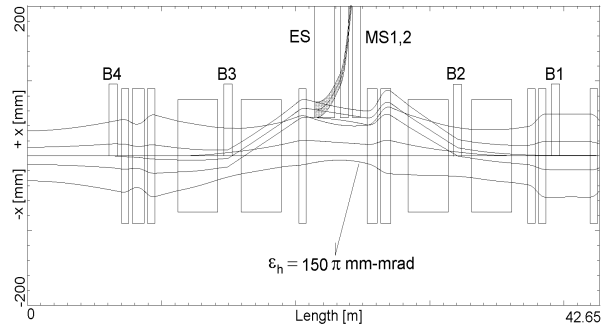

Figure 6 Injection orbit and beam envelope of multiple multiturn injection in the CSRm.

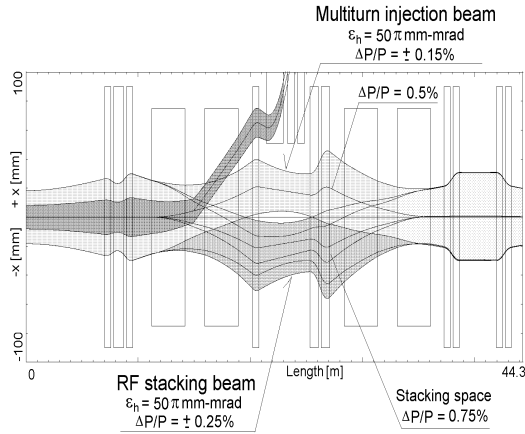

Figure 7 Beam envelopes of multiturn injection and RF stacking in the CSRm.

beam can be just attached onto the accumulated beam. During the multiturn injection the convex orbit will be descended continuously. This injection system will be adapted to the two beam accumulation methods. Figure 6 is the injection orbit and the envelope of the beam accumulated by multiple multiturn injection. Figure 7 is the injection orbit and the beam envelopes of the multiturn injection and the RF stacking.

The fast extraction is shown in Figure 8. Four in-dipole bumping coils will be used first to shift the stored beam to the extraction elements, then using one kicker to kick beam to the extraction orbit, finally the kicked beam will be deflected out of ring by three magnetic septums.

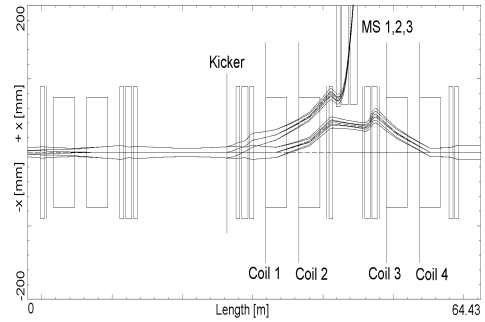

Figure 8 Fast extraction orbit of the CSRm.

The 1/3 resonance extraction method will be adopted by the slow extraction of the CSRm. For the slow extraction six in-dipole bumping coils are used to move the closed orbit, one fast Q-shift quadrupole is used to shift the tune of the ring near to the 1/3 resonance point and two families of sextupoles are used to shrink the horizontal phase space of the stored beam. The resonance beam will be deflected to the extraction orbit by one electric-static septum and extracted finally by the three magnetic septums of the fast extraction. Figure 9 is the slow extraction orbit of the CSRm.

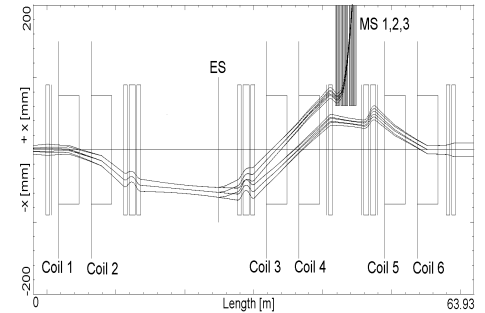

Figure 9 Slow extraction orbit of the CSRm.

### 2.4.3 COD simulations and magnet apertures

According to the simulation of the closed orbit distortion (COD) with misalignment and dipole field error, the maximum  $COD_h(r.m.s)$  is 12mm and the maximum  $COD_h(max.)$  will be 24mm in the horizontal plane, and in the vertical plane the maximum  $COD_v(r.m.s) = 8mm$

and the maximum  $COD_v(\max.) = 18\text{mm}$ , while considering the main misalignments of  $\Delta X, \Delta Y = \pm 0.2\text{mm}$  for the quadrupoles and the dipole tilt along the beam direction  $\Delta\phi = \pm 0.5\text{ mrad}$ , and the dipole field error of  $\Delta B/B = \pm 5 \times 10^{-4}$ . Those errors obey Gauss distributions with  $\pm 2\sigma$ .

The magnet useful aperture consists of three parts. One is the beam net acceptance ( $A_h = 200 \pi \text{ mm-mrad}$ ,  $A_v = 20 \pi \text{ mm-mrad}$ ,  $\Delta P/P = \pm 1.5 \times 10^{-3}$ ), the second one is the COD and the third one is the beam injection channel or extraction channel ( $\epsilon_h, \epsilon_v = 5 \pi \text{ mm-mrad}$ ,  $\Delta P/P = \pm 5 \times 10^{-4}$ , septum = 10mm, error =  $\pm 3\text{mm}$ ). So the magnet useful apertures of the CSRm are finally defined as  $150 \times 70 \text{ mm}^2$  for the dipoles and  $180 \times 104 \text{ mm}^2$  for the quadrupoles.

### 2.5 CSRe Design

The lattice of CSRe is similar to that of the CSRm shown Figure 10. Each arc section consists of two dipoles, one triplet and two doublets. 7 independent variables for quadrupole are used in the CSRe. The lattice of each arc section is given as follows:

$$\begin{array}{c} L_1 \qquad \qquad \qquad L_2 \\ \text{-----DF--B--FD---F--B--FD-----} \end{array}$$

where  $2L_1$  is a long-straight section with dispersion free for e-cooler or internal target.  $2L_2$  is a short straight section with dispersion free for RF cavities. Table 6 is the linear lattice parameters of the CSRm.

Table 6: Lattice parameters of the CSRe

Transition gamma	$\gamma_{tr} = 6.5$
Betatron tune values	$Q_x / Q_y = 3.54 / 2.58$
Natural chromaticity	$Q'_x / Q'_y = -2.3 / -1.7$
Max. $\beta$ -amplitude	$\beta_x / \beta_y = 10.4 / 7.0 \text{ m}$ (Dipole) $\beta_x / \beta_y = 21.3 / 17.5 \text{ m}$ (Quadrupole)
Max. dispersion	$D_{\max}(x) = 1.35 \text{ m}$ (Dipole) $D_{\max}(x) = 3.29 \text{ m}$ (Quadrupole)
Injection section	$\beta_x = 9.3 \text{ m}$ , $D_x = 0 \text{ m}$ (Septum) $\beta_x = 10.9 \text{ m}$ , $D_x = 0 \text{ m}$ (Quadr.)
E-cooler section	$\beta_x / \beta_y = 6.5 / 12.2 \text{ m}$ , $D_x = 0$
RF station section	$\beta_x / \beta_y = 3.2 / 17.2 \text{ m}$ , $D_x = 0$

The injection channel, show in Figure 11, is located in a dispersion free section and goes through the edge of a dipole in order to obtain very large momentum acceptance. The single turn injection system consists of four in-dipole coils to bump the closed orbit, two magnetic septums to deflect beam into CSRe and one kicker to kick the beam to the closed orbit of the ring.

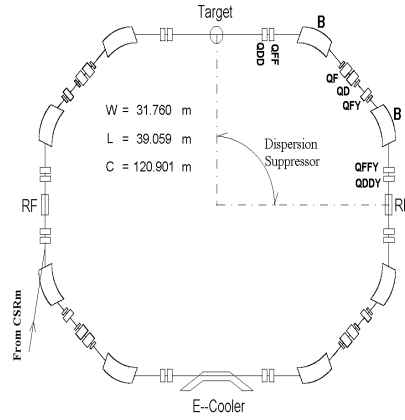

Figure 10 Magnetic-focus structure of the CSRe

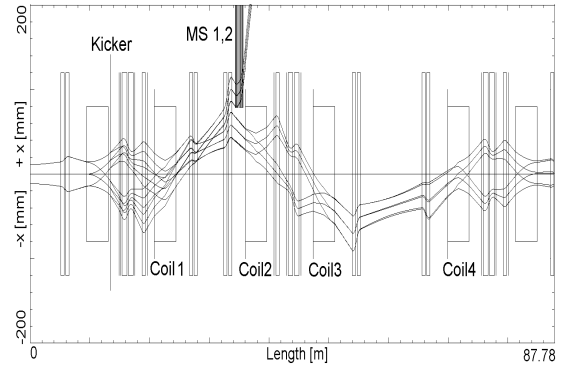

Figure 11 Single turn injection orbit of the CSRe.

The magnet useful apertures of the CSRe are defined as  $150 \times 70 \text{ mm}^2$  for the dipoles and  $240 \times 120 \text{ mm}^2$  for the quadrupoles. It includes two parts which are the pure acceptance and beam injection channel ( $\epsilon_h, \epsilon_v = 20 \pi \text{ mm-mrad}$ ,  $\Delta P/P = \pm 5 \times 10^{-3}$ , septum = 10mm, error =  $\pm 3\text{mm}$ ). The C-type will be adopted for the CSRe dipoles in order to install the experiment probes and injection channel conveniently.

### 3 REFERENCE

- [1] B. W. Wei, "Results From Lanzhou K450 Heavy Ion Cyclotron", Proceeding of 1989 Particle Accelerator Conference, IEEE.
- [2] W. L. Zhan, et al., "Radioactive Ion Beam Line in Lanzhou", this conference
- [3] Y. F. Wang, "Upgrade of HIRFL", this conference.
- [4] B. W. Wei et al., "HIRFL Heavy Ion Cooler-Storage Ring Proposal", Proc. of the 5th China-Japan Joint Symposium on Accelerators for Nuclear Science and Their Appl., 1993.
- [5] B. W. Wei et al., "HIRFL-CSR Proposal", Proc. of the 14th Inter. Confer. on Cyclotrons and their Appl., 1995.
- [6] J. W. Xia et al., "HIRFL-CSR Plan", Proc. of the 6th China-Japan Joint Symposium on Accelerators for Nuclear Science and Their Appl., 1996.