

Superconducting RF activity at L.N.L.

A. M. Porcellato, G. Bisoffi, G. P. Buso, F. Chiurlotto, S. Gustafsson, A. Facco, M. Morvillo, V. Palmieri, V. Ruzinov, J. S. Sokolowski, S. Y. Stark, G. Bassato, A. Battistella, M. Bellato, S. Canella, M. Cavenago, M. F. Cervellera, A. Dainelli, P. Favaron, G. Fortuna, A. Lombardi, M. F. Moisisio, R. Pengo, M. Poggi and G. Ziomi

I.N.F.N. Laboratori Nazionali di Legnaro - Legnaro (Padova) Italy

Introduction

The construction of the superconducting linac for heavy ions Alpi (fig. 1), which was started in 1989, has been the main effort of the L.N.L..

The Linac structure [1] includes 97, independently phased, superconducting, quarter wave resonators (QWR). The medium β section of the accelerator (48 accelerating + 1 bunching + 2 rebunching resonators) is close to its completion [2]. At present 10 cryostats (8 containing four resonator each, the remaining two containing the bunching and rebunching cavities) are installed on the beam line and connected to the refrigerator. Two more units are ready to be put on the beam line and the assembling of the remaining two will be completed by the end of the year.

The state of the Alpi project and the experience in resonator construction and operation are reported here, together with the very encouraging results obtained in the test of bulk Nb and sputtered Nb QWR prototypes.

The L.N.L laboratory is involved in an INFN-CERN R.F. Superconductivity Project aiming at the production of cavity prototypes for future linear colliders. The results obtained in this field will conclude the report.

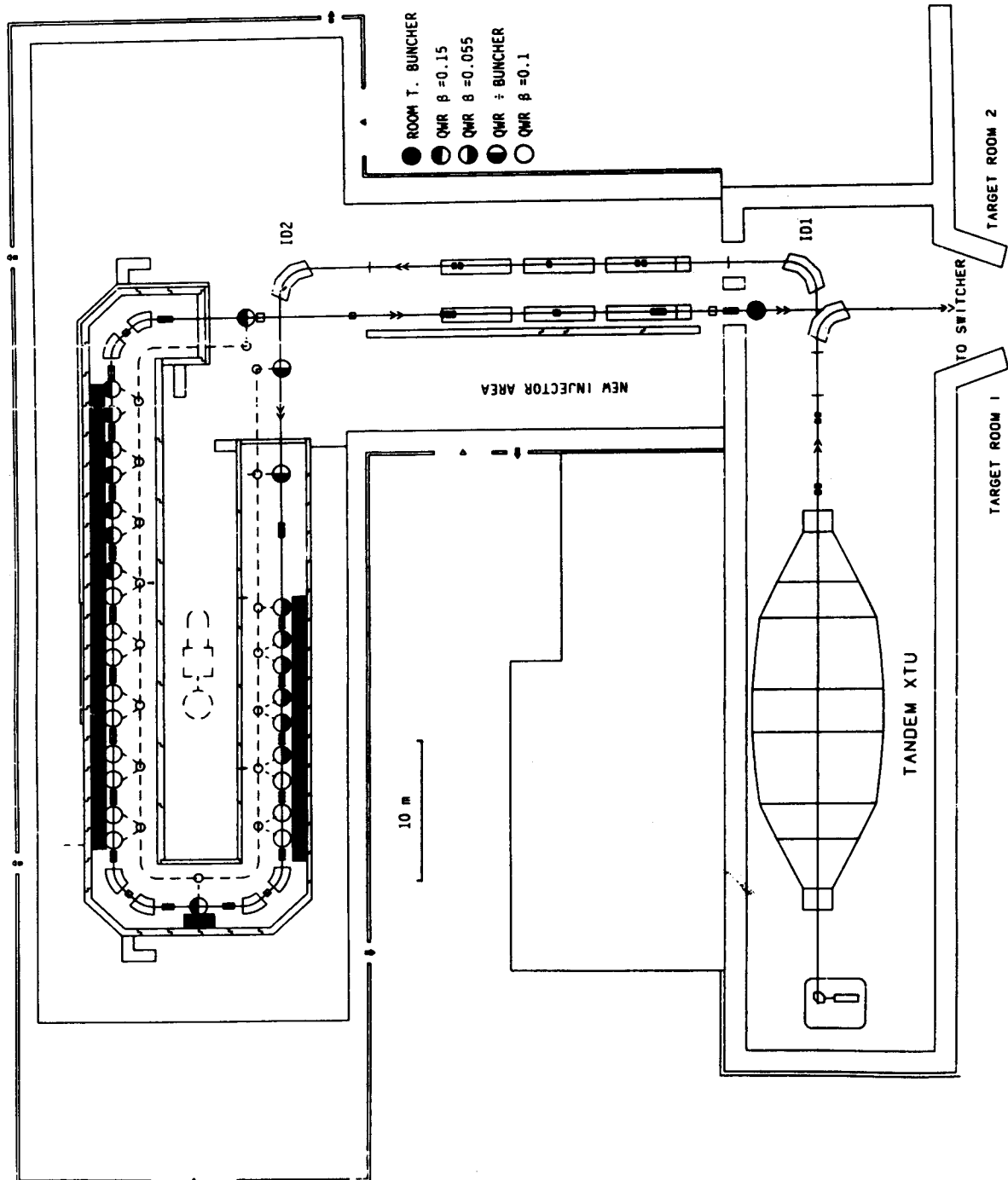

Fig. 1. The final layout of the ALPI linac.

Status of the ALPI Accelerator project

The Linac building covering a 2475 [m²] area was completed in December 1990.

The installation of conventional technological infrastructure followed in 1991, allowing the installation and the alignment of the magnets (2x90⁰, 6x45⁰, 2x7⁰, 6 quadrupole singlets, 3 doublets and 23 triplets). The test, of the whole transport system (magnets, power supplies, software) was performed at the end of 1992 allowing the transport of a ⁵⁸Ni¹⁰⁺ beam to the experimental hall through the linac.

According to the initial schedule, the cryogenic system [3] has been realized in two stages. The first, aimed at supplying cryogenic power to 14 cryostats of the medium beta section, was completed in 1991 and enabled the first RF cryogenic test of 12 resonators in July 1992. Economic reasons suggested to advance the realization of the second and final cryogenic configuration (3 KW at 4.5 K and 1550 W at 60 K): this summer the plant was completed and is now under commissioning.

The concrete walls for radiation shielding are in place. They were planned to allow the access to the location of electronic and control devices inside the Linac hall during beam operation.

The 27 diagnostic boxes (12 located in the double waist between cryostats and 15 in other crucial points of the transport line) are also in place. Each box houses a beam profile monitor (24 are grids, 3 quartzes). A target holder and a silicon detector can be easily inserted, where necessary, to verify the time structure of the beam. Ten of the diagnostic boxes are equipped with a Faraday cup. The related electronics and software, developed in a real time high performance operating system, have been completed and tested.

The low energy components of the new pulsing system [5] are routinely in operation since 1991. The 5 MHz post-tandem chopper, the 10 MHz postchopper, the phase detector, the S.C. buncher and the two rebunching QW resonators have been successfully used to bunch the beam during tests. Installation of the 80 MHz S.C. bulk Nb buncher [6] is foreseen in the beginning of next year. The system will be completed with two rebuncher units consisting of a couple of superconducting cavities and a normal-conducting re-entrant cavity. The management of the normal-conducting elements of the pulsing system is performed through an assigned software, integrated in the Linac control system.

The 15 cryostats of the medium beta section of the linac structure were delivered in 1991. Ten of them are already on the beam line and connected to the refrigerator. The cryostat assembling time has been slower than foreseen. Small but time consuming problems very often slowed down the assembling procedure [7]. Now anyway, all the hardware installed in the cryostats seems to work properly. Minor changes in the cryostat structure, which enabled easy adjustment of the resonator position with respect to the cryostat beam ports, made the alignment procedure a little faster. In spite of the fact that the cryostats are not cold tested before insertion on the beam line, no cold leaks developed in the installed ones. The vacuum in the cryostat before cooling is in the 10^{-7} mbar range, becoming about two orders of magnitude lower at working temperature.

The vacuum control is performed locally, through dedicated units and communicates, via serial links, with the Linac control system.

The software for running (or supervising) the various Linac subsystems (vacuum, magnets, beam diagnostics, pulsing, RF resonator control, and cryogenic system) has been developed and extensively tested, showing to be reliable and easy to use [8].

Amplitude and phase lock of each resonator is provided by microprocessor based controller which showed to operate according to specifications. The setting of the RF controller parameters is realized through a graphical interface at a console workstation. The same interface is used to control coupler and tuner positions [9]. The resonator locking procedure seems to be easy to follow and takes only a few minutes. Software tools which make the search for the optimum parameter settings faster and more accurate have been developed and are now under test. The software to run a process in which several subsystems are interacting is under development: it will allow automatic adjustment of the resonator phase through beam diagnostics information, setting of resonator baking, RF conditioning, alarm management, etc.

The ECR ion source Alice was tested. The basement for its platform was completed. A theoretical work on microwave-plasma interaction and the non stationary feeding of metal into the source, together with to an extensive equipment check, were performed while waiting for source final installation.

First commissioning tests

A first test of the behaviour of the whole Linac system was performed in July '92 when three cryostats (8 accelerating cavities and a bunching cavity) were cooled down. After baking (at 350 K for about 12 hours) and thermal shield refrigeration, each cavity (fig. 2) was multipactoring conditioned about 6 hours long. Due to the short time available before a scheduled electrical power shut-down, it was decided to perform only a very fast RF conditioning of the resonators at He temperature, without systematic tests of resonator characteristics through Q-curve measurements. It was possible to set the accelerating field and to lock the resonator phase to the external reference, after frequency and coupling adjustment, without any particular problems, but, once the pulsing system was adjusted, no time was left for bunched beam acceleration and only a D.C. beam was accelerated cavity by cavity.

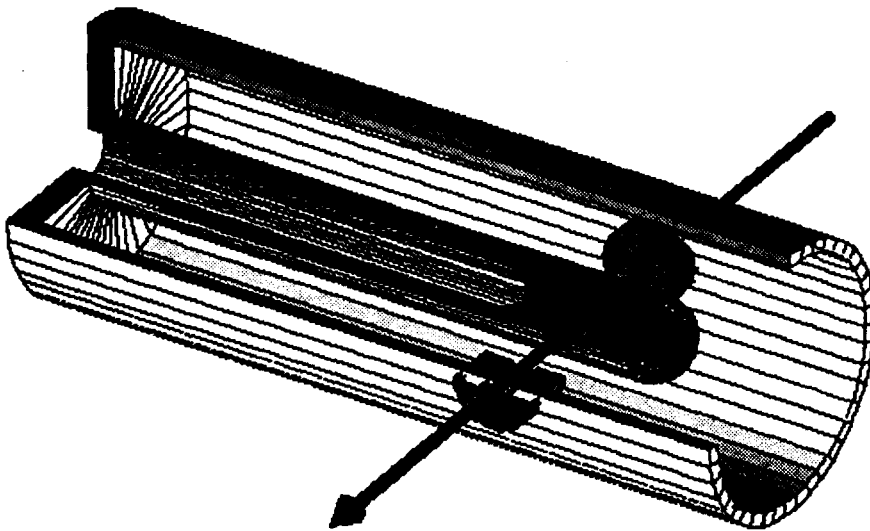

Fig. 2 Medium β , lead on copper resonator view. The substrate peculiarity is the absence of E. B. welding. The E_p/E_a ratio is 4.6, H_p/E_a is 104 Gauss/(MV/m), $U/E_a = 64$ mJ/(MV/m)², the active length is 18 cm. During test it was possible to get 4 MV/m at 7.8 W dissipated power. 36 of them are now installed on the beam line.

A shut-down of the refrigerator leads to warming up of the cryostats due to the choice of cooling the cryostat thermal shield by He gas (at 60 K and 7 bar). Consequently, last spring, the resonators had to be reconditioned, before cooling them down to He temperature. The process, performed without a previous baking, took about two hours per resonator. The short time was probably due to the good vacuum in the cryostats during room temperature standby.

The use of the self exciting loop designed for the resonator control helps significantly in performing the procedure, because the suitable resonator frequency is automatically set (important in our case where the temperature is not fixed by the nitrogen bath) and because we are not limited by the need of external additional instrumentation.

The resonator accelerating fields, measured on the beam line at 7 W, give a mean value of about 2 MV/m (fig. 3). It is lower than the design goal (3 MV/m). It has however to be taken into account that the resonators were not well conditioned, since it was just possible to perform one hour RF conditioning (without He) for each of them. We were not expecting better results both because of difficulties found in setting up the plating procedure and for the necessity of venting several times the resonators with nitrogen, due to alignment problems.

After a first short test of the beam transport conditions for a 195 MeV $^{58}\text{Ni}^{13+}$ beam, the resonator performance tests continued. The beam energy was monitored by a Surface Barrier Silicon Detector after elastic scattering by a thin gold target. The energy gain, as a function of phase, produced by each resonator was then measured, in order to find the suitable (-20°) phase setting for the beam transport and to verify the accelerating field calibration obtained by electronic measurement. In about half a day it was possible to phase lock correctly 12 resonators and to increase the beam energy by 36 MeV.

In the following and last test at the end of April the phasing of the resonators, located in the first section of the Linac, was performed, looking at the dispersion effect of a couple of 45° dipoles on the beam as a function of the resonator phase. In the same way, looking at the beam on the grids downstream the second couple of 45° dipoles, it was possible to set the right phase of the rebuncher cavities. This method seemed to be faster and more suitable for automation than the previous one.

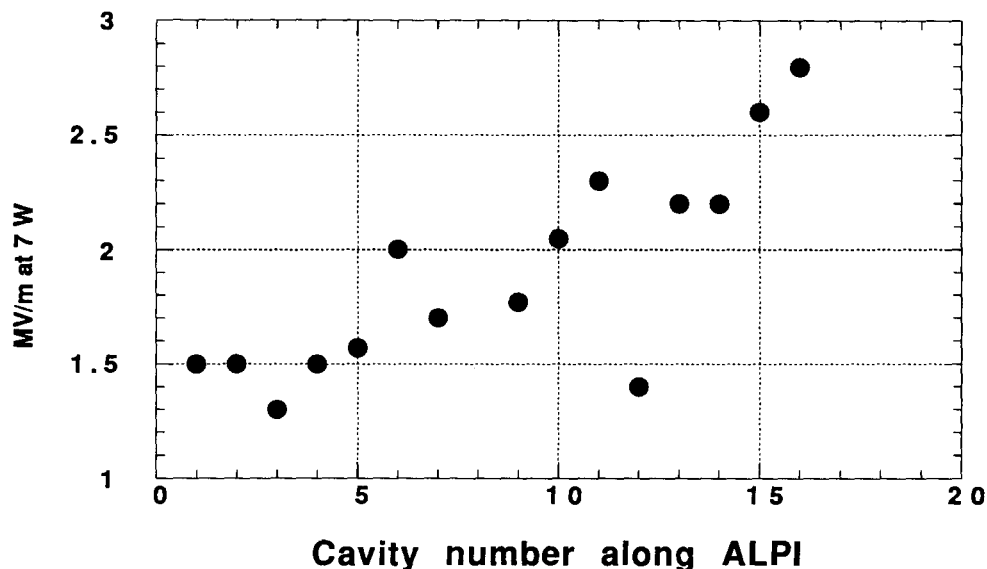

Fig. 3 Medium β cavity accelerating field along Alpi.

Experience with medium β lead-copper cavity production

The peculiarity of the medium β Alpi cavity construction is the absence of E.B. welding. All the joints are obtained by in-house vacuum brazing. The technology proved to be very reliable (no failures so far): it provides invisible connections and no deterioration turned up after repeated plating and stripping procedures.

On the other hand the search for the correct plating procedure has been more difficult than foreseen. The good results obtained with the prototypes could not be reproduced in the production stage. Some chemical problems affecting on the cavity performance have been found in more than 25 plating tests: plating solution contamination by copper oxide present in not enough cleaned substrate, lead-hydroxide caused by the chemical attack of lead by high resistivity water, shinol aging, deterioration of deionized water prepared in advance [7].

Other parameters suspected to influence the superconducting characteristics of the lead film are under investigation now: rule of fluoroboric and boric acid concentration in the bath, copper contamination of a heavily used solution and others.

The reduction of the number of free parameters involved in the process surely helps in reducing the risk of failure. For this reason the chemical polishing of the lead surface was eliminated and the rinsing procedure has been simplified. After the EDTA and citric acid treatments, just several further cycles of hot (60°), deionized water rinsing are foreseen. Hot nitrogen gas is used to dry the resonator. The resulting surface is now always uniform, with neither shadow nor powder and the time necessary for the whole plating procedure is substantially reduced.

Chemical polishing of the copper substrate seems to be useful. Even if we did not find, probably for having used very old plating solutions, a substantial Q_0 improvement, the multipactoring conditioning time has been anyhow reduced by a factor of two.

We are confident that the use of a new plating solution, will allow us to reproduce the old results.

The possibility to use the more stable lead-tin alloy instead of pure lead as a superconductor has been investigated. The results are not bad, Q_0 is slightly higher than 2×10^8 , and the accelerating field at 7 W is similar to the one obtained at present with lead, i.e. 2-2.4 MV/m. In the three tests we used the standard 93:7 lead-tin bath concentration, without aiming at any optimization. Apparently, the problems are very similar to the ones with pure lead, and we believe that a possible future change to lead-tin, once decided, will not pose any relevant problems. At present priority is assigned to having the cavities on the beam line and not much time is left for tests.

Low- β bulk Nb resonator

The possibility of using bulk Nb QW resonators in the low- β section of the Linac was suggested by the good performance of the 160 MHz prototype tested in 1990: 5 MV/m could be sustained by a 10 W dissipated power [11].

Through a simple scaling of the resonator length to halve the frequency, a resonator with the suitable β value could be obtained (fig. 4)[6]. Some of the resonator parts and equipment were identical to the ones used for 160 Mhz, thus making its design and construction easier.

In addition to the better superconducting properties of Nb with respect to Pb, the resonator handling is relatively easier due to the lower weight.

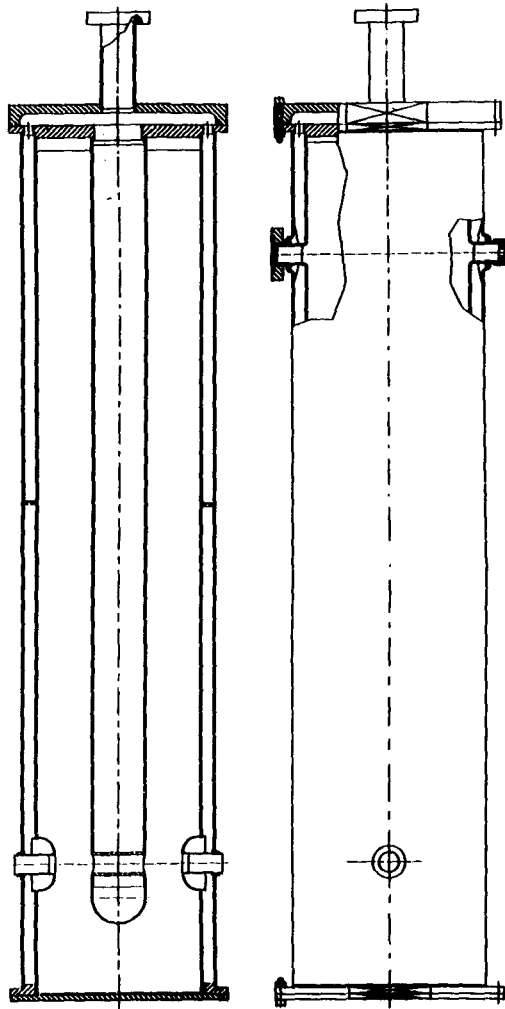

Fig. 4 Low β , 80 MHz bulk Nb resonator. It is all bulk Nb, only the bottom plate is Nb sputtered on copper. The E_p/E_a ratio is 4.9, H_p/E_a is 100 Gauss/(MV/m), $U/E_a = 114$ mJ/(MV/m)², the active length is 18 cm.

The double wall all-niobium cavity structure assures a good cooling of the resonator and allows high temperature treatments.

The test program aimed at verifying the Q-value as a function of accelerating field, mechanical resonances, sensitivity to external mechanical noise and to He bath pressure changes are presented elsewhere at this workshop [12] and are only briefly mentioned here. The low field Q-value was high (1.4×10^9) and exceeded 1×10^9 over 4 MV/m (sustained at 1 W dissipated power) where a sudden breakdown appeared (fig. 5). A short 300 W He-conditioning cycle did not improve the result.

The resonator showed to be reasonably sensitive to mechanical and pressure disturbances, but this did not affect the capability of the standard control system to lock phase and amplitude of the overcoupled cavity to an external reference in the noisy laboratory condition. Unlocking was not detected while increasing the He bath pressure from 1 to 1.4 bar.

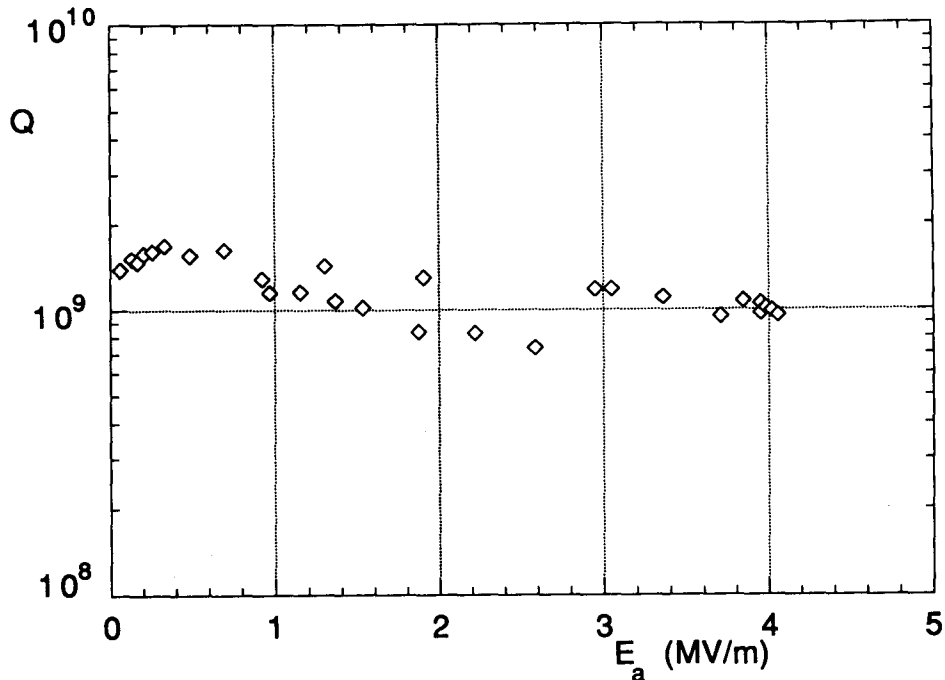

Fig. 5 Low- β 80 MHz Nb resonator performance.

The resonator prototype will serve as the 80 MHz superbuncher of the Alpi Linac and will be installed in the beam line as soon as the cryostat is available. Six more cavities are now under construction and will be installed as soon as possible to verify their behaviour in operation. Such resonators will be used as accelerating elements of the low- β section of ALPI.

QW Nb sputtering development

The possibility of substituting the lead coating of the Alpi resonators with Niobium is very attractive. A research program aimed at the studies of Nb sputtered copper based Q.W. resonator started in 1988.

Details of the method, treatment and procedure are described elsewhere in this workshop [13]. Here we mention only the systematic approach to the problem which allowed to point out the different parameters affecting the resulting film characteristics and which lead to a gradual improvement of the Nb film quality [14,15,16,17]. A big enhancement in the resonator performance resulted after completely rounding the top plate to cylinder transition of the test resonator. This small change in the geometry, while not affecting the electromagnetic characteristics of the cavity, solved the problem of bad film quality in the

connections between inner and outer conductor and the cavity top plate. The resonator performance jumped up to a Q-value of 2×10^9 , and to an accelerating field of 6.7 MV/m at 7 W, the maximum accelerating field resulted 9.1 MV/m (fig. 5). The test of the last sputtered prototype with an increased film thickness showed a higher Q-value (3×10^9), but the reachable field was limited by field emission to 7 MV/m. High pressure water rinsing of the Nb coating reduced the low field Q (1.7×10^9), but enhanced the limiting field to 9.0 MV/m.

The results are approaching those of the more expensive JAERI cavities, if one considers the increased active length of LNL resonator (20% higher) [18].

A laboratory for chemical treatment, sputtering, cleaning, assembling and test of resonators is under construction at Legnaro. It will allow to complete the Alpi cavity production at reduced costs and, if necessary, to renew the installed ones.

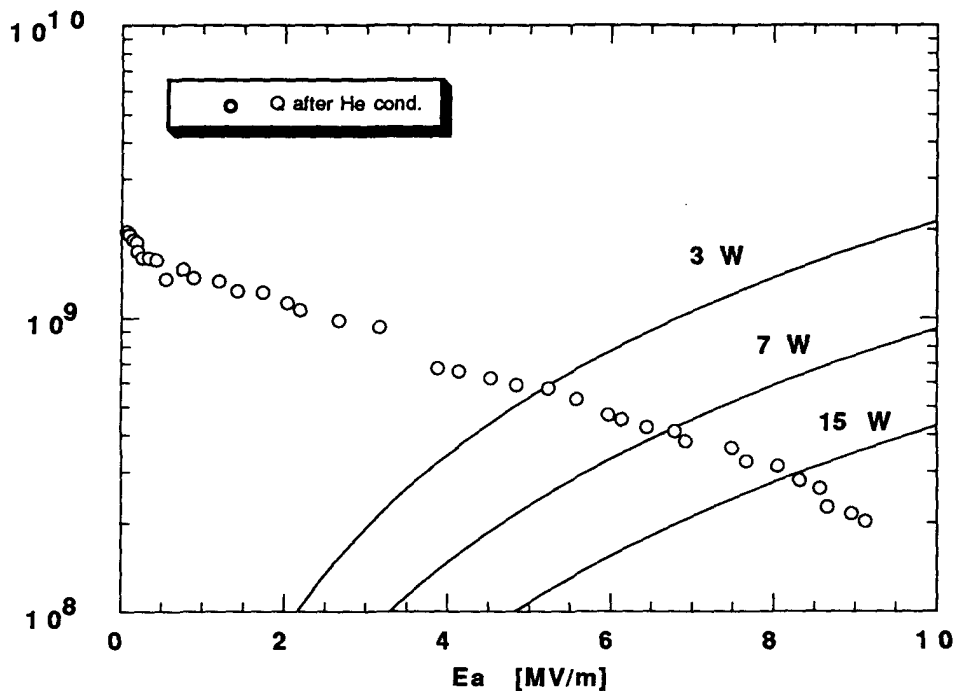

Fig. 6 Performance of 160 MHz sputtered Nb on Cu test resonator measured at 4.2 k. The E_p/E_a ratio is 4.6, H_p/E_a is 104 Gauss/(MV/m), $U/E_a = 64$ mJ/(MV/m)², the active length is 18 cm.

Development of cavities for future Linear Colliders

In the framework of an INFN-CERN collaboration for the development of superconducting cavities for future linear colliders, a research project aimed at investigating sputtered 1.5 GHz copper cavities started.

An innovative technique for producing seamless cavity by spinning was developed. The resonator (fig.7) completed with cut-off tubes, is spun from a 3 mm thick OFHC copper or from 1.5 mm niobium foil. Both monocell and multicell resonator, can be produced by this technique. The method is described elsewhere [18] in these proceeding.

At the moment a magnetron sputtering configuration for niobium coating of monocells is under preparation.

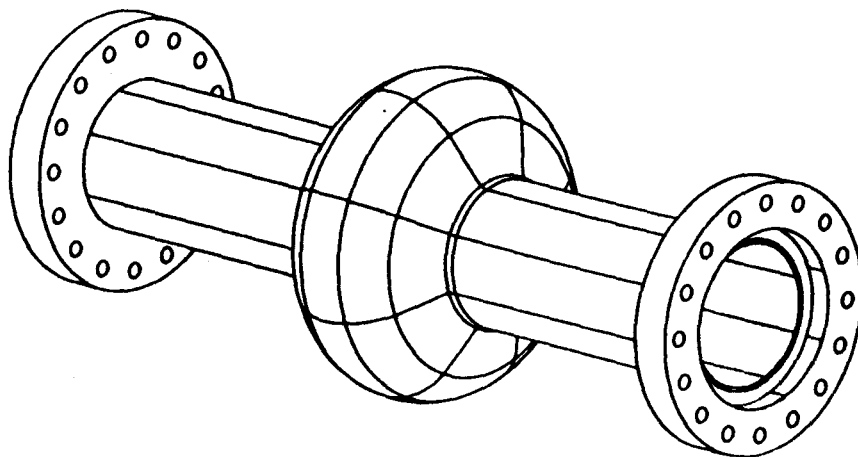

Fig.7 Sketch of the 1.5 GHz cavity under investigation at L.N.L.

REFERENCES

- 1 G. Fortuna, R. Pengo et al., "The Alpi Project at the Laboratori Nazionali di Legnaro" Nucl. Instr. and Meth. **A287** (1990) 253
- 2 G. Fortuna, A. M. Porcellato, G. Bassato, A. Battistella, M. Bellato, L. Bertazzo, G. Bezzon, G. Bisoffi, G.P. Buso, S. Canella, M. Cavenago, F. Cervellera, A. F. Chiurlotto, Dainelli, N. Dainese, M. De Lazzari, A. Facco, P. Favaron, M. Lollo, A. Lombardi, S. Marigo, M. F. Moisis, V. Palmieri, R. Pengo, M. Poggi, A. M. Porcellato, F. Scarpa, J. S. Sokolowski, L. Badan, M. Barbadillo, R.

- Pegoraro, R. Preciso and F. Scarpa, "Completion of the medium- β section of the ALPI SC-booster at LNL", Nucl. Instr. and Meth. **A328** (1993) 236
- 3 R. Pengo, P. Favaron, G. P. Buso, L. Ziomi, A. Beltramin, T. Contran and F. Poletto "Cryogenics and related topics of the Alpi linac", Nucl. Instr. and Meth. **A328** (1993) 242
- 4 M. Bellato, A. Dainelli, M. Poggi, "The Beam Diagnostics System of the ALPI Post Accelerator", Proceedings of the Third European Particle Accelerator Conference, Berlin March 24-28 1992 Edition *Frontieres* (1993) 1085
- 5 A. Facco, K. Rudolph, A. Battistella, G. Tombola, F. Scarpa, A. Zanon, "The Alpi Linac Pulsing System", Proceedings of the Third European Particle Accelerator Conference, Berlin March 24-28 1992, Edition *Frontieres* (1993) 1507
- 6 A. Facco and J. S. Sokolowski "The bulk niobium resonator program at L.N.L." Nucl. Instr. and Meth. **A328** (1993) 275
- 7 A.M. Porcellato, G. P. Buso, V. Palmieri, F. Chiurlotto, V.L. Ruzinov, S. Yu Stark, G. Bisoffi, P. Favaron, G. Fortuna, S. Gosh, Hu Yue Ming, V. Kurakin, A. Lombardi, R. Pengo, K. Rudolph, J. Sokolowski, L. Badan, M. Bellato, L. Bertazzo, A. Beltramin, T. Contran, M. Lollo, S. Marigo, F. Poletto and R. Preciso, "Lead Resonator Production and Sputtering Niobium Development at LNL", 26th Symposium of North Eastern Accelerator Personnel, September 23-25 1992, Hull Quebec and Chalk River Labs, Ontario, in press
- 8 G. Bassato, A. Battistella, M. Bellato and S. Canella, "The Control System of the L.N.L. linac" Proceedings of the Third European Particle Accelerator Conference, Berlin March 24-28 1992, Edition *Frontieres* (1993) 1145
- 9 G. Bassato, A. Battistella, M. Bellato and S. Canella, "Automation of procedures for locking ALPI resonators" Nucl. Instr. and Meth. **A328** (1993) 195
- 10 M. Cavenago and G. Bisoffi "Commissioning of the ECR ion source Alice" Nucl. Instr. and Meth. **A328** (1993) 262
- 11 I. Ben-Zvi, E. Chiaveri, B.V. Elkonin, A. Facco and J.S. Sokolowski, Proc. of 2nd EPAC, Nice 1990 Vol. 2, 1103
- 12 A. Facco and J. S. Sokolowski "Results of New Measurements on the 80 MHz Bulk Niobium Resonator", this Conference
- 13 Palmieri et al. "Nb sputtered QWR's", this Conference
- 14 V. Palmieri, R. Preciso, V. L. Ruzinov, S. Yu. Stark, L. Badan and A.M. Porcellato "Sputtering of Niobium Thin Films onto Copper Quarter Wave Resonator" 5th Workshop on RF Superconductivity, August 19-23 1991, Desy Hamburg, Germany, DESY M 92-01 (1992) 1145

- 15 V. Palmieri, V. L. Ruzinov, S. Yu Stark, O. B. Malishev, R. Preciso, A. M. Porcellato, L. Badan, J. S. Sokolowski, G. P. Buso, F. Chiurlotto, F. Poletto, "Niobium Sputtered Quarter Wave resonators" European Particle Accelerator Conference, Berlin March 24-28 1992, 1292
- 16 V. Palmieri, V. L. Ruzinov, S. Yu. Stark, L. Badan, A.M. Porcellato, "Superconducting Niobium Thin Film Sputtering onto Copper Quarter Wave Resonators for heavy ion accelerator" Nucl. Instr. and Meth. **A328** (1993) 280
- 17 V. Palmieri, V.L. Ruzinov, S. Yu Stark, R. Preciso, L. Badan and A. M. Porcellato, "Superconducting Niobium Thin Film Sputtering onto Copper Quarter Wave Resonator for Heavy Ion Accelerators" IEEE Transaction of Applied Superconductivity V. 3 (1993) 193
- 18 T. Ishii, M. Shibata and S. Takeuchi, "Construction of the JAERI tandem booster" Nucl. Instr and Meth. **A328** (1993) 231
- 19 V. Palmieri et al., "Forming of Seam-less Cavities by the Spinning Technique", this Conference