

DESIGN OF DIES WITH RIGHT CAVITY GEOMETRY FOR A PROTON SC LINAC*

Kenji Saito[#], Shuichi Noguchi, H.Inoue, KEK, 1-1 Oho Tsukuba-shi, Ibaraki-ken, Japan
 T. Ohta, MHI, Takasago Research & Development Centre,
 2-2-1 Sinhama Arai-cho, Takasago-shi, Hyogo-ken, Japan
 T.Yanagisawa and K.Nakanishi^{##}, MHI Kobe Shipyard & Machinery Works,
 Wadamisaki-cho, Hyogo-ku, Kobe-shi, Japan
 H.Umezawa, Tokyo Denkai Co. Ltd., 1-3-20, Higashisuna, Koutou-ku, Tokyo-to, Japan

Abstract

To date, application of superconducting RF cavity is extended to the proton LINAC like SNS project in USA. In proton sc LINACs, phase and amplitude controls are much severe due to the heavy proton mass. As a result, the tolerance of cavity fabrication becomes tight compared with electron sc RF applications. Half-cell of the cavity must have the right designed shape. Generally the half-cell formed by deep drawing deforms after the trimming due to spring-back. The forming die must be designed considering this effect. We have designed and fabricated several sets of deep drawing die for 972MHz and $b=0.725$, simulating this effect by mechanical structure analysis cavities, and formed half-cells using the dies. We have succeeded to make the die for the half-cell having a forming error less than 0.3mm. In this paper, the results are presented.

INTRODUCTION

Superconducting (sc) niobium cavities are currently fabricated by electron beam welding half-cells, which are formed by deep drawing. Pressing niobium sheets then, trimming on a lathe forms half-cells. After that they are electron beam welded together. Now this sc RF technology is extended to proton LINACs in the SNS project [1] or other planning projects [2]. As the proton LINAC requires a tight phase control and severe RF field accuracy in the cavities within one degree and 1%, respectively. The accuracy of one degree in the phase corresponds to 0.62mm long at 972MHz with longitudinal direction. Such a severe tolerance makes tight the cavity fabrication error. In cavity fabrication procedure, really there are many processes making the fabrication error: forming, trimming, electron beam welding, annealing and pre-tuning so on. For the establishment of the tight tolerance, we need to evaluate it in each process. Here, as the first step we have investigated the forming error in the half-cell by simulation used structure analysis code PAMSTAMP.

In section 2, we explain the simulation. In section 3, we report the forming error in half-cells by the KEK current die design method (die-2002). In 2003, we had a chance to make a new shape for the upgraded 972MHz

9-cell structure at $b=0.725$. From the experience of die-2002, we upgraded our design method for the new die (die 2003-1). In section 4, we will describe about the new die. In addition, we fabricated another die (2003-2) feeding back those two experiences in order to make a die having a smaller forming error less than 0.3mm. In section 5, we will present the results, and discussion will be done in section 6.

SIMULATION

In plastic working, true stress σ [N/mm²=MPa] is given as:

$$\sigma = F \cdot \epsilon^n,$$

here, F [N/mm²] is a plastic coefficient of the material and ϵ true stain (logarithmic strain), and n -value. σ and ϵ are defined by the nominal stress (s) and the nominal stain (e) as follows:

$$\sigma = s \cdot (1 + e)$$

$$\epsilon = \ln(1 + e),$$

$$s = \frac{P}{A_0},$$

$$e = \frac{\Delta d}{d},$$

where, P [N] is a loaded force, A_0 [mm²] an area of the cross-section of the sample, d [mm] distance of the marked points, Δd [mm] amount of the displacement. In our simulation, the plastic coefficient and n -value were experimentally determined with the niobium sheet material (RRR=300) from Tokyo Denkai for three angles: 0°, 45° and 90° from the rolling direction. The mechanical test with the niobium sheet was repeated three times for each angle, and the averaged value was used. Fig.1 shows the characteristic curves between true stain and true stress. The n -values were obtained fitting the data as:

$$\sigma(0^\circ) = 334.16 \cdot \epsilon^{0.3147}, \sigma(45^\circ) = 356.73 \cdot \epsilon^{0.3256}, \sigma(90^\circ) = 353.48 \cdot \epsilon^{0.3188}$$

By the ratio of plastic stains: r -value, is defined as:

* This work is supported by Ministry of Education, Culture, Sports, Science and Technology.

ksaito@post.kek.jp, ## He has left MHI. Now he is studying in KEK as a student of the Grad. Univ. Advanced Studies.

$$r = \frac{\epsilon_w}{\epsilon_t}$$

here, ϵ_w is true strain in direction of the width of the sample and ϵ_t is that of the thickness. It reflects the inhomogeneity of the material. Fig.2 is the measurement

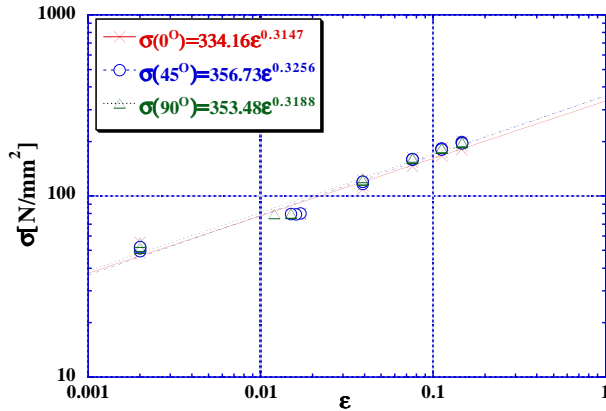

Figure 1: Measure the characteristics curve between strain and true stress.

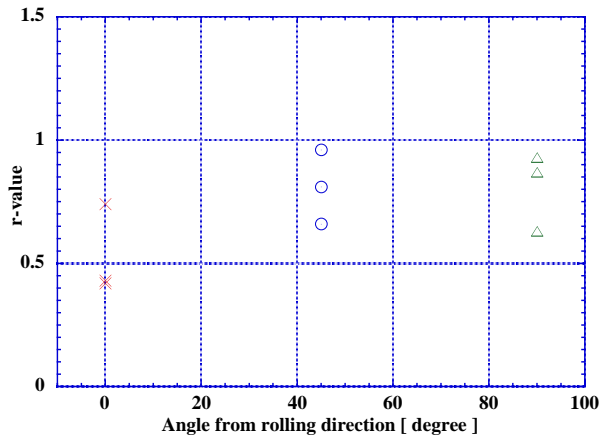

Figure 2: r-values in the three directions from the rolling direction.

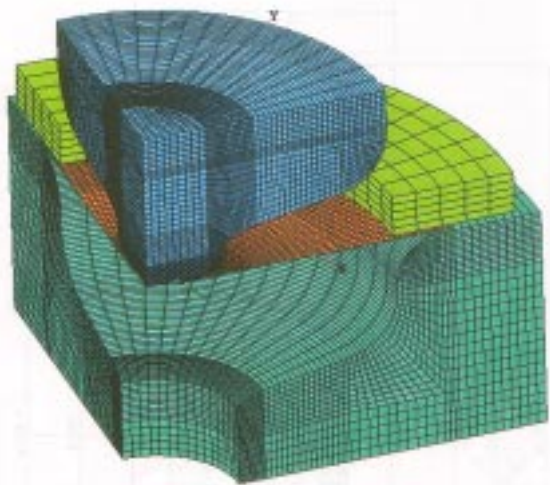

Figure 3: Meshing of the dies in the simulation.

Table 1: Used parameters in the simulation

Analysis code	PAMSTAMP
Plastic coefficient for niobium	348 N/mm ²
n-value	0.32
r-value (Measured values for Tokyo Denkai Nb material)	r ₀ = 0.43 r ₄₅ = 0.885 r ₉₀ = 0.75 (Suffice means the angle from the rolling direction)
Young's modulus	105 kN/mm ²
Poisson's ratio	0.38
Density	8.57 g/cm ³
Simulation accuracy	~ 0.3mm

Table 2: Mechanical properties of KEK deep drawing die

	Tensile [N/mm ²]	Yield [N/mm ²]	Elongation [%]
YH75	570	500	11
JIS A7075-T6	>540	>475	>7

results for the three directions mentioned above. In our simulation we averaged the two data omitting the mostdeviated result from other two. The results are:

$$r(0^\circ) = 0.43, r(45^\circ) = 0.885, r(90^\circ) = 0.75.$$

Fig.3 shows the meshing in the simulation. The number of segments was 49 in radial direction, of which largest size is 5mm and smallest 2mm. The number of segment on the quarter circle is 45 in every 2 degrees. Thus, the number of total mesh is 2205.

The die material for deep drawing is aluminum alloy so called YH75, which is no Japanese Industrial Standard (JIS). JIS A7075 is close to the material. In Table2, the mechanical properties are listed for both.

DIE 2002

Die 2002

In 2002, we fabricated a 972MHz 9-cell cavity for the JPARC phase-II. The cavity design is in other paper [3]. Fig.4 shows the half-cell design of the centre-cell in the structure. The niobium material is 3 mm thick. Fig.5 is the set of deep drawing die for this half-cell shape. These dies were designed by the current KEK design method, where the inner surface of the male die is the same as the designed half-cell shape. The reduction in the wall thickness in the formed half-cell is not considered. The fabricated dies were measured by the 3-D measurement system (ZEIZZ) in KEK. The machining error was within 100µm.

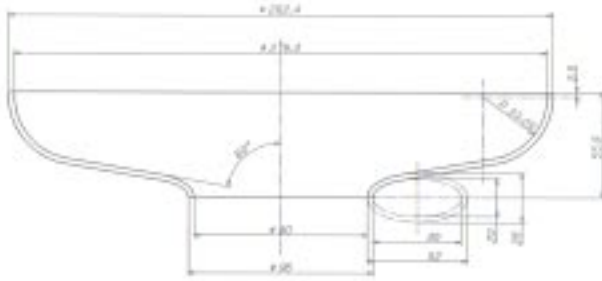

Figure 4: Half-cell design with Die-2002.

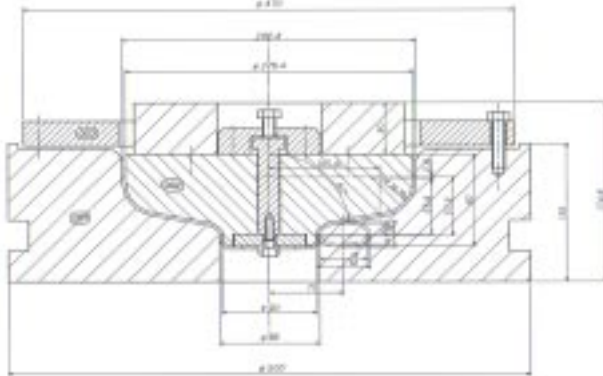

Figure 5: The set of deep drawing Die-2002.

Shape Errors in On Pressing by Die-2002

Fig. 6 shows the typical simulation result (0-degree) for the forming by Die 2002 with just on pressing (half-cell cup). The calculation was done with angles 0°, 45° and 90° as mentioned already, and the results have no remarkable difference among these directions. This simulation foresees that at the equator circle the formed half-cell surface will be in by maximum 0.29mm from the design half-cell geometry and at the end point of the circle it will be in by 0.43mm. The male die will not perfectly press out the sheet. In contrast at the ellipse it is out by 0.63 mm and at the iris out by 0.93mm. Pressing is too much in this area.

Shape Error in Off Pressing by Die- 2002

Fig.7 shows the typical simulation result (0-degree) with the off pressing, which means releasing the loading on the die with the half-cup. In this case, mismatching becomes larger due to spring-back. At the equator circle, the formed surface will be in by 0.67 mm from the designed geometry and at the end point of the circle it is in by 0.76mm. While at the ellipse sections, it is no changes from that of results in the case of on pressing.

Frequency Error by Die 2002

Fig.8 shows the segment location of the half-cell and the sensitivity of the frequency shift by errors in R and Z, which was calculated using the SUPERFISH code [4]. Let's calculate frequency shifts by the forming errors for the case of the off pressing. The normal frequency shift for variations Δr and Δz by SUPERFISH, directions at the four points in Fig.7 (A,B,C and D), which are defined as positive to the inside of half- cell surface, were 50°(A),

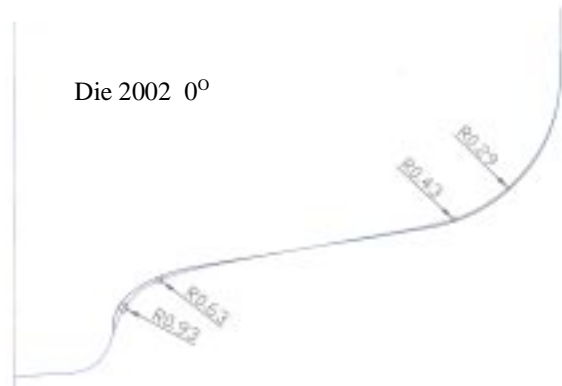

Figure 6: Simulation results with Die-2002 just on pressing.

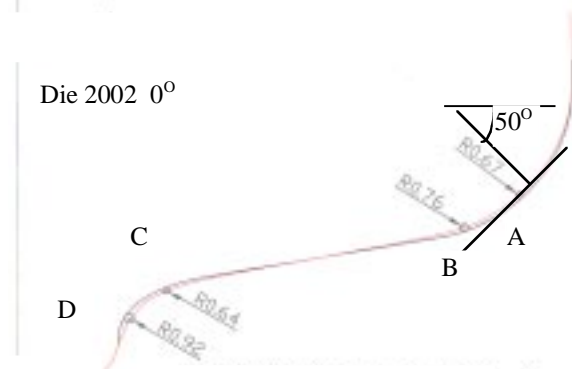

Figure 7: Simulation result with Die-2002 off pressing.

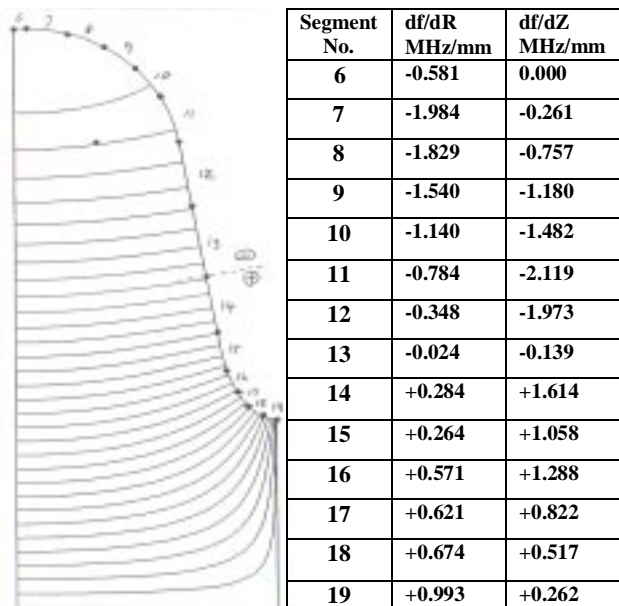

Figure 8: Segment location and the sensitivity of R-axis.

71°(B), 70°(C) and 30°(D) with the as seen in Fig. 8, these locations: A, B, C and D correspond to the segment 9,10,16 and 18, respectively. The frequency shifts from each segment are:

$$\begin{aligned} \Delta f(A(\Delta r)) &= -0.67 \cdot \cos(50^\circ) \cdot (-1.540) = +0.663\text{MHz} \\ \Delta f(A(\Delta z)) &= -0.67 \cdot \sin(50^\circ) \cdot (-1.180) = +0.606\text{MHz} \\ \Delta f(B(\Delta r)) &= -0.76 \cdot \cos(71^\circ) \cdot (-1.140) = +0.282\text{MHz} \\ \Delta f(B(\Delta z)) &= -0.76 \cdot \sin(71^\circ) \cdot (-1.482) = +1.065\text{MHz} \\ \Delta f(C(\Delta r)) &= +0.64 \cdot \cos(70^\circ) \cdot (+0.571) = +0.125\text{MHz} \\ \Delta f(C(\Delta z)) &= +0.64 \cdot \sin(70^\circ) \cdot (+1.288) = +0.775\text{MHz} \\ \Delta f(D(\Delta r)) &= +0.92 \cdot \cos(30^\circ) \cdot (+0.674) = +0.537\text{MHz} \\ \Delta f(D(\Delta z)) &= +0.92 \cdot \sin(30^\circ) \cdot (+0.517) = +0.238\text{MHz} \end{aligned}$$

$$\text{Total } \Delta f = +4.291\text{MHz}$$

The total frequency shift is about +4.3MHz and too much. The contribution by the errors at equator section is more than half of the total.

DIE 2003-1

Die 2003-1

In 2003, we fabricated the other 972MHz 9-cell structure as an upgraded structure but the shape of the centre-cell is little different from that of 2002, only the end-cells have rather different shape. The detailed cavity design is seen in the reference [3]. The thickness of niobium material was changed to 4 mm in order to increase the stiffness of the structure against Lorenz detuning. Here we analysed the centre-cell. Fig.9 shows the newly designed half-cell shape. Fig.10 is the set of deep drawing die: Die 2003-1 for this half-cell shape. In order to decrease the amount of spring-back after off pressing, we upgraded the die design method as follows:

- a) the diameters of ellipse were shortened from those in the half-cell designed geometry:
 the half-cell design value (long axis) 52mm → 50mm,
 the half-cell design value (short axis) 26mm → 25.4mm,
- b) the radius of equator circle was shortened from 33.0 mm (half-cell designed shape) to 32.79 mm and the center of the circle was moved out by 0.30mm.

Shape Error in On Loading Die 2003-1

Fig.11 is the simulation result of the half-cell cup just on loading by Die 2003-1. Forming errors decreased to about one half of those by Die 2002 in both equator and iris sections. Especially the equator section was rather pressed out.

Shape Error in Off Loading Die 2003-1

However, leasing the load from the die, the errors became larger by the spring-back as seen in Fig.12. We realized that the spring-back after off pressing is so large.

Thickness Reduction around The Iris

Fig.13 shows the simulation about the half-cell wall thickness after forming. The original niobium material is 4 mm thick as mentioned above. The wall thickness is rather uniform in the cell but is reduced to 3.4 mm at the

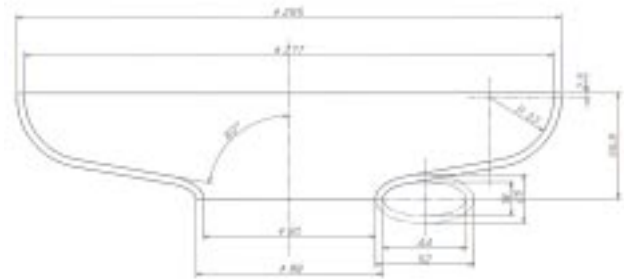

Figure 9: The designed half-cell shape for the upgraded 972MHz 9-cell structure.

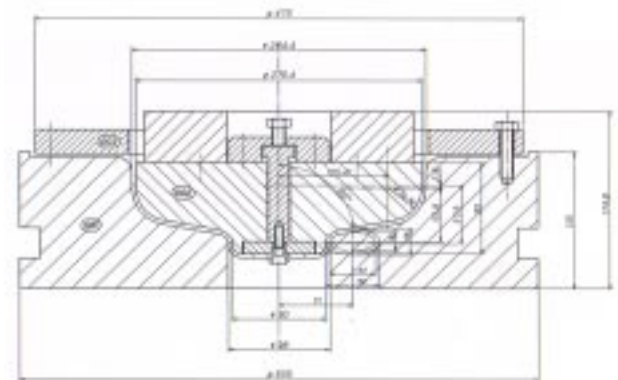

Figure 10: The set of deep drawing Die 2003-1.

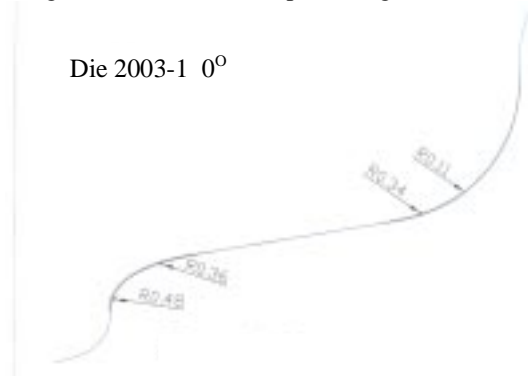

Figure 11: Simulation result for the half-cup just on loading Die 2003-1.

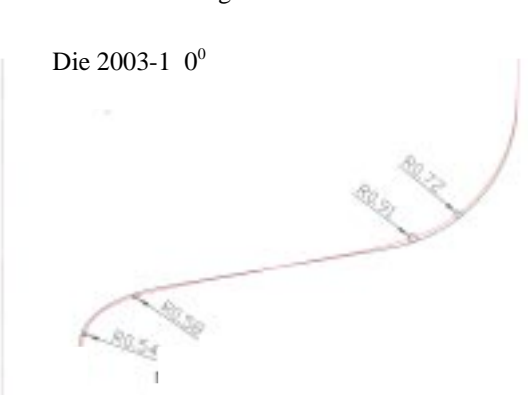

Figure 12: Simulation result for the half-cell just off loading Die 2003-1.

iris. The thickness reduction is remarkable around the ellipse section.

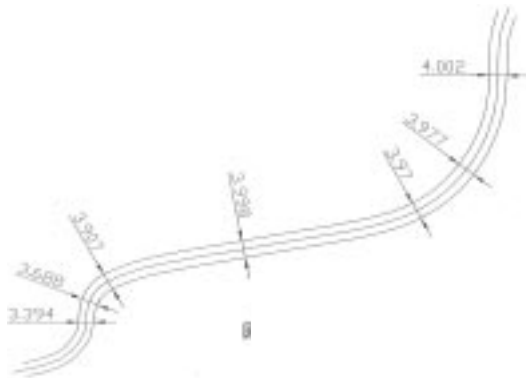

Figure 13: Simulated wall thickness distribution by Die 2003-1.

DIE 2003-2

Die 2003-2

As the forming error is large after off loading with Die 2003-1, we have fabricated again another new deep drawing die (2003-2) for the same half-cell shape. In this die design, we had collaboration with MHI. Keeping two means (a) and (b) in Die 2003-1, the following three points were cured:

- 1) Angle of the straight section in the die was changed from 80° (half-cell design) to 81° for a cure of spring back,
- 2) Ellipse section in the female die was overhung by the amount of reduction of the half-cell wall thickness
- 3) Diameter of the center hole in the niobium sheet was increased to 63 mm in order to suppress the thickness reduction.

Fig.14 shows the design of the set of deep drawing die reflecting these cures. Fig.15 shows the simulated detailed result about the wall thickness with Die 2003-1, of which result was reflected in Die 2003-2 design. At the ellipse section, the amount of overhang was added by the thickness reduction estimated in Fig.15.

Shape Error in On Loading Die 2003-2

As seen in Fig.16, these cures are successfully reflected in the on loading. The errors in this case deduced to one half of Die 2003-1. The circular section in the cell is pushed out by 0.64mm from the designed half-cell geometry.

Shape Error in Off Loading Die 2003-2

Fig.17 shows the simulated shape for the off loading with Die 2003-2. The errors were lowered to 1/2 or 1/3 of Die 2003-1. At off loading, the circular section has a spring-back toward the inside of the cell. The amount of spring-back is 0.92mm surprisingly.

Shape Error After Removed from Die 2003-2

The half-cup was removed from the die and the geometry was measured with 3-D shape measurement system. The

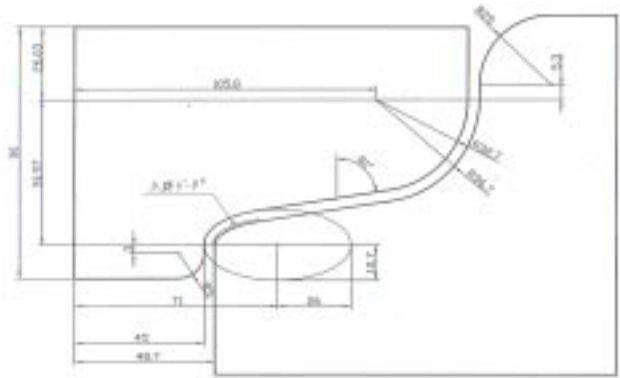

Figure 14: The set of deep drawing die (Die 2003-2).

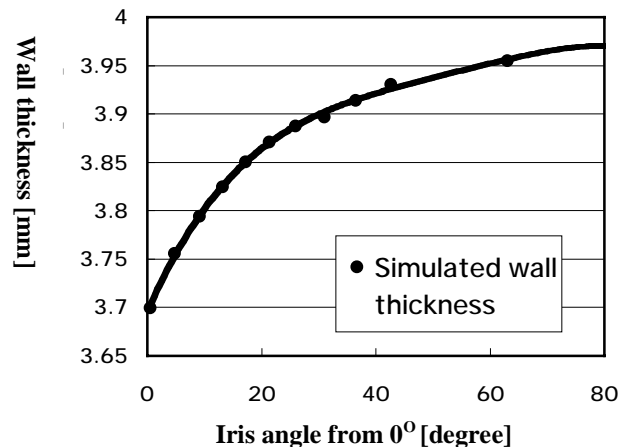

Figure 15: Estimated wall thickness at the iris section by Die 2003-1.

Die 2003-2 0°

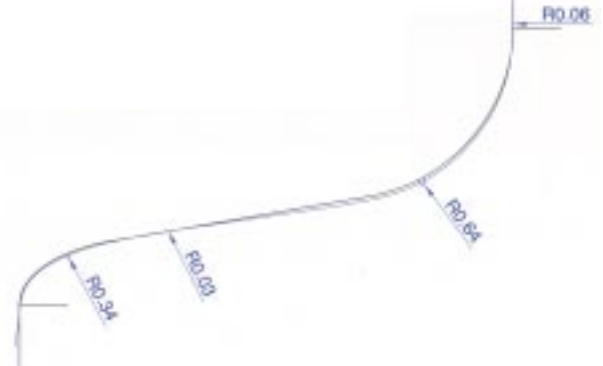

Figure 16: Simulation result for Die 2003-2 on loading.

result is presented in Fig.18. The constrained condition should be changed from the off pressing. In this case, the circular section became the designed half-cell shape. Even considering about such a different constrained condition between off pressing and after removed the die, we can conclude the simulation gives a very good prospect for the die design.

Shape Error after trimming

The half-cup was finally trimmed to half-cell in order to measure the machining effect on the sprig-back. The result is presented in Fig. 20. By cutting the ear at the equator section, one can see a trend that the circular section in the cell shrinks while the iris section expands after cutting the bottom. Finally we have succeeded to make half-cell within an error less than 0.3mm. Calculating the frequency shifts due to the errors in the machined half-cell results are:

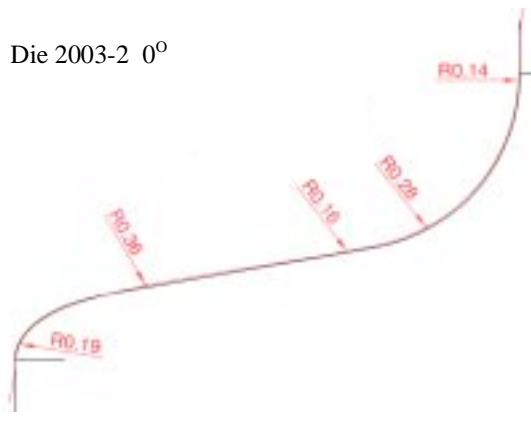

Figure 17: Simulation result for Die 2003-2 on off loading.

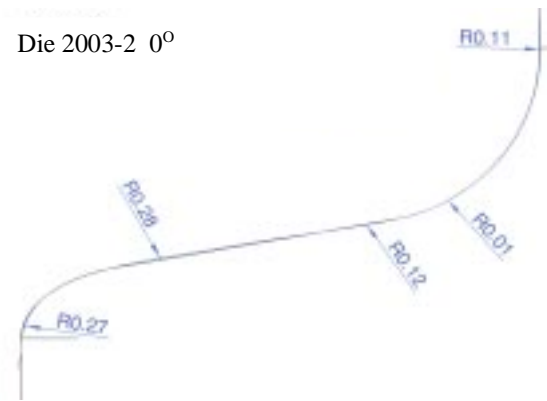

Figure 18: Shape measurement of the half-cup after removed from the die.

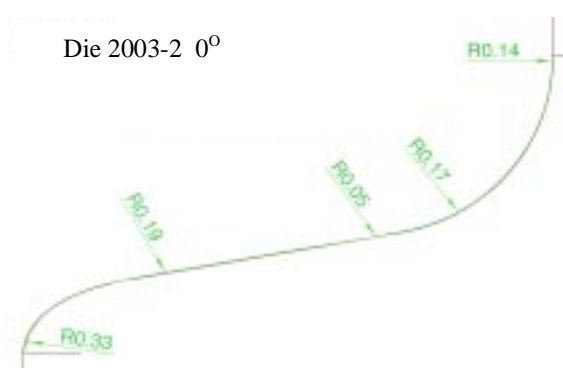

Figure 19: Shape measurement of the half-cell after trimmed.

$$\Delta f(E(\Delta r)) = -0.14 \cdot (-0.581) = +0.081 \text{MHz}$$

$$\Delta f(E(\Delta z)) = 0 \cdot 0 = 0 \text{MHz}$$

$$\Delta f(A(\Delta r)) = -0.17 \cdot \cos(50^\circ) \cdot (-1.540) = +0.168 \text{MHz}$$

$$\Delta f(A(\Delta z)) = -0.17 \cdot \sin(50^\circ) \cdot (-1.180) = +0.154 \text{MHz}$$

$$\Delta f(B(\Delta r)) = -0.05 \cdot \cos(71^\circ) \cdot (-1.140) = +0.019 \text{MHz}$$

$$\Delta f(B(\Delta z)) = -0.05 \cdot \sin(71^\circ) \cdot (-1.482) = +0.070 \text{MHz}$$

$$\Delta f(C(\Delta r)) = -0.19 \cdot \cos(70^\circ) \cdot (+0.571) = -0.037 \text{MHz}$$

$$\Delta f(C(\Delta z)) = -0.19 \cdot \sin(70^\circ) \cdot (+1.288) = -0.230 \text{MHz}$$

$$\Delta f(D(\Delta r)) = +0.33 \cdot \cos(30^\circ) \cdot (+0.674) = +0.193 \text{MHz}$$

$$\Delta f(D(\Delta z)) = +0.33 \cdot \sin(30^\circ) \cdot (+0.517) = +0.085 \text{MHz}$$

Total Δf = +0.503MHz

The total frequency shift in a half-cell will be about +0.5MHz, which was reduced to 1/8 of that by Die 2002.

DISCUSSION

Cornering

Re-pressing the ellipse section in the half-cell cup, which is called as cornering, is conducted after the deep drawing in Jlab. In our deep drawing process, it had been done for L-band cavities, but currently it is stopped in order to make simple deep drawing process. Cornering might be a cure for the spring back in the iris section. However, it is less effective for the spring back in the equator section.

Effect of Inhomogeneity in Materials

The simulation result depends on inhomogeneity of the niobium materials. Table 2 shows inhomogeneity of the niobium material used in this simulation. The variation is within 5% at the maximum for each mechanical property with three directions. The material is rather uniform.

Figs.20-21 are the results of shape measurement of the half-cell by Die 2003-2. Forming errors are not different so much among these three directions. Table 3 summarizes the errors at the 4 locations and at the equator in the half-cell.

Table 2: Inhomogeneities with mechanical parameters of the used niobium materials in our simulation

Angle [deg]	Hardness Vickers	0.2% Yield strength [N/mm ²]	σ _{max} [N/mm ²]	Elongation [%]
0	48.1	55.37	178.72	49.4
		55.26	178.74	43.5
		49.48	177.56	52.5
Average	48.1	55.37 ± 3.36	178.34 ± 0.68	48.5 ± 4.6
45	48.1	49.75	170.15	48.2
		51.10	176.75	48.6
		51.45	176.10	50.6
Average	48.1	50.77 ± 0.90	174.33 ± 3.64	49.1 ± 1.3
90	48.1	48.49	165.27	56.5
		51.10	173.91	51.0
		52.22	174.72	49.4
Average	48.1	50.60 ± 1.91	171.30 ± 5.24	52.3 ± 3.7

Die 2003-2 0°

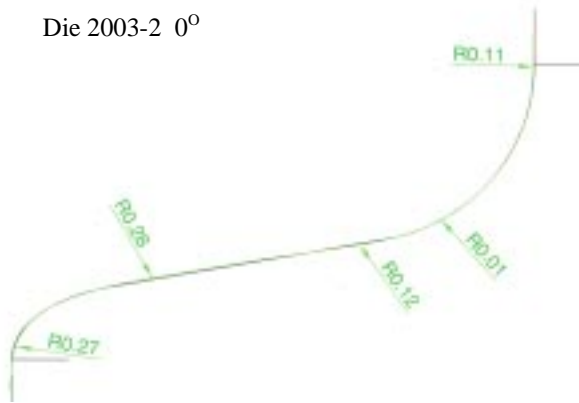

Figure 19: Shape measurement result of the half-cell in the direction of 0°.

Die 2003-2 45°

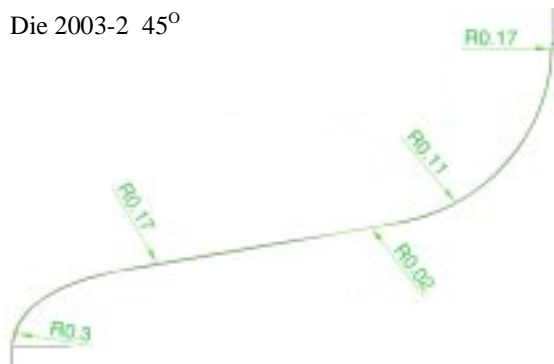

Figure 20: Shape measurement result of the half-cell in the direction of 45°.

Die 2003-2 90°

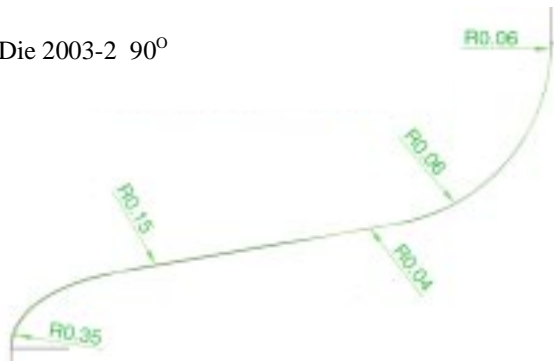

Figure 21 Shape measurement result of the half-cell in the direction of 90°.

Table 3: Forming errors at the 5 locations on the half-cell

Location	0° [mm]	45° [mm]	90° [mm]	Average [mm]
Equator	-0.11	-0.17	-0.06	-0.11±0.06
A	-0.01	-0.11	-0.06	-0.06±0.05
B	-0.12	-0.02	-0.04	-0.06±0.05
C	-0.28	-0.17	-0.15	-0.20±0.07
D	+0.27	+0.30	+0.35	+0.31±0.04

Other Effect on The Fabrication Error

We have many other processes making fabrication error. Generally saying, electron beam welding or annealing gives shrinkages in the cell. These effects on the geometry will be investigated in further study.

Pre-tuning is the final process to make uniform field distribution and right frequency of the structure. This deforms only the ellipse section in our tuning method [5]. As seen in the previous section with Die-2002, the frequency shift due to the forming error in the equator section contributes more than one half of the total frequency shift. If we adjust the structure to have the right frequency by the tuning system, too much deformation will be made on the ellipse section and that brings a phase error. longitudinally. On the other hand, the tuning system has no problem in case of the die 2003-2 because it has small forming errors on the equator section.

SUMMARY

We have successfully designed and fabricated the deep drawing die, of which the forming error is less than 0.3 mm. From these experiences, the following design method is useful.

- 1) In the die design, the equator circle should be smaller a little bit (~0.6%) and the centre must be pushed out a few from that of half-cell design.
- 2) The diameters of the ellipse also should be smaller (~0.4%) and the centre has to be shift inside by the shortage.
- 3) The taper of the straight section (if there is) must be deeper by a little bit (~0.125%) from that of half-cell design.
- 4) The ellipse section should be designed considering about the reduction of wall thickness in deep drawing.
- 5) The diameter of centre hole in a niobium sheet should be so large as that the half-cup is not stuck on the female die after the deep drawing.

REFERENCES

- [1] Y.Cho et al., “ Evolution of the SNS Superconducting Proton LINAC”, Proc. of the 10th Workshop on Superconductivity, 2001, Tsukuba, Japan, pp.95 – 99.
- [2] S.Noguchi, in this workshop, “Prototype Cryomodule for the ADS LINAC”, MoP32.
- [3] E. Kako and S. Noguchi., “RF Design of a 972MHz Superconducting Cavity for High Intensity Proton Linac”, Proc. of EPAC2002, Paris, France, June 3 – 7, 2002, pp. 2244 – 2246.
- [4] This calculation was done by E.Kako.
- [5] T.Shishido et al., “Development of Pre-tuning System for 972Mhz 9cell Superconducting Cavities”, in this workshop, TuP42.