

# TUNER SYSTEM ASSEMBLY AND TESTS FOR THE 201-MHZ MICE CAVITY

L.Somaschini, INFN-Pisa, Pisa, Italy

A. Moretti, R. J. Pasquinelli, D. W. Peterson, Y. Torun, FNAL, Batavia, USA

P. M. Hanlet, IIT, Chicago, USA

A. J. DeMello, D. Li, S. Virostek, LBNL, Berkeley, USA

## Abstract

The MICE cavities include a mechanical tuning system consisting of stainless steel flexure forks attached to the cavity body and driven by pneumatic actuators. The first of these systems was assembled and tested at Fermilab for use at the MuCool Test Area. The actuators were calibrated on a test hoop. The cavity body was measured and the fork contact pads machined to fit. Actuators are going to be mounted on the vacuum vessel housing the cavity. The transfer function of the tuning system and the quality factor of the cavity will be measured with the recently implemented frequency control software.

## MICE CAVITY AND TUNER

Each acceleration module (RFCC) of the MICE experiment [1] is composed of four normal-conducting cavities made of copper with a nominal resonant frequency of 201.25 MHz (fig. 1) [2]. The four cavities will be mounted into a vacuum vessel in order to have the same pressure on both sides and avoid deformation of the cavity when pulling vacuum. The cavities will have to work in a high magnetic field that can reach 3T on some points of the cavities surface [3]: a tuning system able to work in such an environment had to be designed. Each cavity will be equipped with a pneumatic system of 6 tuners composed of an actuator and a fork. Each fork, made of stainless steel, will be inside the vacuum vessel and it will stretch and squeeze the cavity when operated by the respective actuator. The actuators will be located outside of the vacuum vessel and will share vacuum with the vessel by means of bellows. All 6 actuators will be connected in parallel and will be controlled by two electronic valves, one responsible for pushing the actuator

shaft and the other one for pulling the shaft. The main aim of the tuner will be to compensate for thermal drift of the cavity and for structural differences between the 4 of them, keeping all the cavities at the same resonant frequency.

A test module with only one cavity has been built and is about to be tested in the MuCool Test Area (MTA) at FNAL [4].

## TEST STAND

### Equipment

The six actuators, since working in parallel, had to be tested for possible gas leaks and for uniform response. To do that, a test stand was built at LBNL (fig. 2): a tuning fork was mounted on an aluminum hoop with a spring constant equal to 1/6 of the spring constant of the cavity. The test hoop was placed on an aluminum plate embedding a conflat flange necessary to screw the vacuum bellows of the actuators under test.

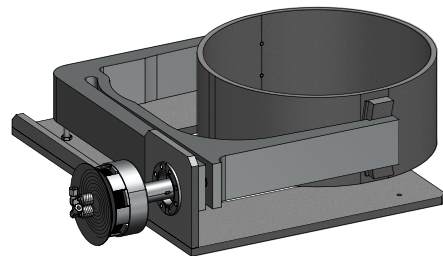

Figure 2: Tuning fork and actuator.

The actuators were controlled by two QPV proportional valves by ProportionAir. Those were connected to a computer running a LabView program. During the test, the pressure applied to each actuator was recorded from proportional valve readout and checked against an analog pressure gauge. The deflection on the test hoop diameter was measured with a dial gauge with a precision of 0.0005 inches, while a linear potentiometer was placed on the fork and aligned with the actuator shaft. The linear potentiometer used is by Novotechnik and it offers a 5 kΩ resistance over a mechanical range of 10 cm. It is powered with a stable 10V signal provided by a voltage regulator. The output voltage is directly proportional to the position of the shaft and consequently the voltage variation is proportional to the actuator shaft movement and to the variation in the fork gap (fig. 3). The voltage was read with a National Instrument ADC and recorded with a LabView code.

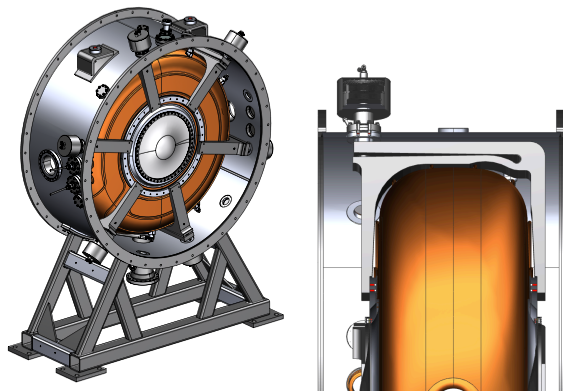

Figure 1: The MTA cavity module and the tuning system.

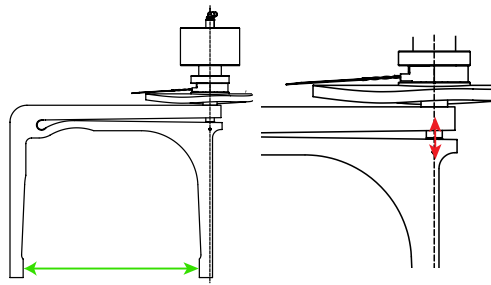

Figure 3: Deflection (left) and fork gap variation (right).

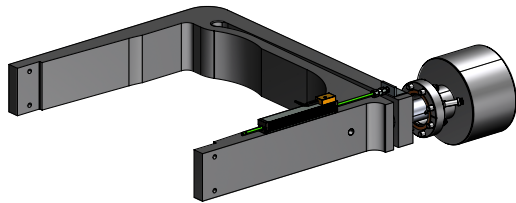

Figure 4: Linear potentiometer on the fork.

**Test**

In the following, +/- pressures refer to squeeze/stretch mode. For each actuator, the test started at 0 PSI and then the pressure was raised directly to 80 PSI. From this value it was lowered to -80 PSI in steps of 10 PSI and then raised again to 80 PSI with the same step size. The plot of hoop deflection as a function of pressure (fig. 5) shows a clear hysteresis cycle and also a small difference between the slope at positive and negative pressures. The same features appear also in the plot of fork gap variation as a function of pressure. However, when the deflection was plotted as a function of the fork gap variation, the hysteresis almost disappeared and the slopes at positive and negative pressures were much more similar. The tuning fork can be viewed as a mechanical system whose transfer function connects the actuator shaft position (input) and hoop deflection (output). Since its transfer function is linear, the nonlinearity is due to something

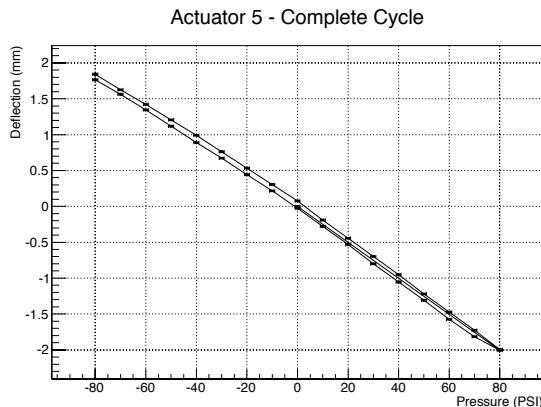

Figure 5: Plot of Deflection vs Pressure for actuator 5.

external and cannot depend on friction between the hoop and the aluminum plate, as initially suspected. The small nonlinearity is likely caused by the actuators and in order to confirm this thesis, the mean of the two points at the same pressure in the hysteresis cycle was computed. The plots of deflection as a function of pressure and deflection as a function of fork gap variation showed a 13% difference between the squeeze and stretch slopes, as expected. On the other hand, the plot of deflection as a function of fork gap variation showed the same slopes (0.13% difference), confirming the actuators as the main source of nonlinearity (fig. 6).

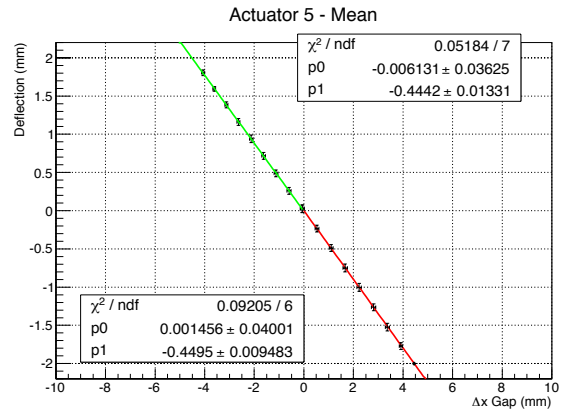

Figure 6: Slopes for stretch (green) and squeeze (red) mode.

Figure 7 shows the slopes for all 6 actuators. In the squeeze mode, all the actuators responded similarly and the results were compatible within the errors. In the stretch mode, the behavior was not as uniform as expected (tab. 1). The maximum slope difference between two actuators was 0.0011 mm/PSI which translates into a difference of 0.11mm or 12% at the maximum tuning pressure of 100 PSI. All 6 actuators will operate simultaneously and the resulting behavior will be the sum of the responses, so this small spread in slope will have no significant operational effect.

Table 1: Actuator Slopes

Actuator	Stretch (mm/PSI)	Squeeze (mm/PSI)
1	0.0224	0.0252
2	0.0225	0.0255
3	0.0233	0.0255
4	0.0227	0.0255
5	0.0222	0.0253
6	0.0229	0.0256

## ASSEMBLY

### Upgrade

After the measurements on the test stand were completed, the equipment was moved to Lab 6 where a clean room is located. The cavity and the vacuum vessel were surveyed using a laser scanner. The fork contact pads were shaved to match the ring on the cavity that they will be bolted onto and to achieve precise alignment with

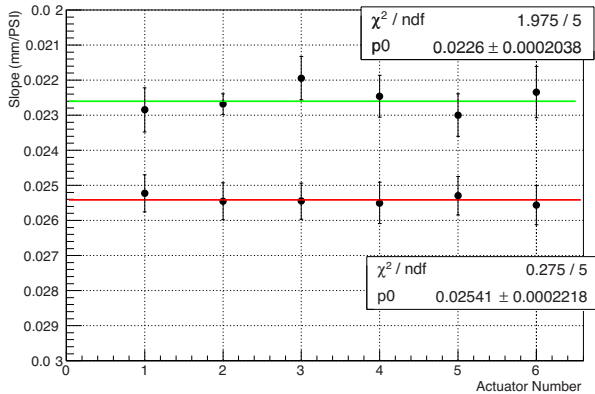

Figure 7: Actuators group behavior.

the vacuum vessel ports. Stainless steel shims will be used as needed between fork contact pads and the mounting rings for fine alignment.

The actuator control system was upgraded. The analog pressure gauges were replaced by electronic units by Omega with 4-20 mA current output. All plastic lines and fittings were replaced with copper tubing and brass fittings. Teflon tape used for thread sealing was replaced with radiation compatible Hercules real-tuff sealant. A valve panel was designed and assembled to allow for manual isolation of each of the 6 actuators and will be mounted directly on the vessel.

Since the cleanroom ceiling is low, the vacuum vessel was placed on a lower stand during assembly. However there isn't enough clearance at the bottom for mounting one of the actuators in this configuration. The test actuator was slightly modified to fit under the shorter stand. It has the same internal components and the same response but it has no vacuum bellows or housing.

A programmable logic controller (PLC) was added to the electronic chain. This is now responsible for the communication with the proportional valves and the electronic pressure gauges. Valve control and pressure readout are currently performed by the PLC at a rate of 1 Hz. The LabView control software is now interfaced with the PLC and not directly with the valves.

Preliminary RF measurements on the cavity were performed while it was positioned on a vertical stand and aluminum windows were installed. The measurements were completed with two B field couplers, a small loop and a bigger one as the input port to obtain critical

coupling. The loaded Q measured in transmission mode was 19700 and the unloaded Q, measured in reflection mode, was 40300. The resonant frequency was 200.801 MHz with a drift of about 5 kHz depending on the room temperature.

### Future Tests

For tuning tests on the cavity, both the cavity and the vacuum vessel will be moved into a clean room. The tuning forks will be installed on the cavity while it will be mounted horizontally on a fixture. Another custom fixture will be used to install the cavity in the vacuum vessel. The actuators will be screwed onto the forks and low level RF tests will begin in order to measure the transfer function of the tuning system. The vacuum vessel will have no side covers and there will be no vacuum inside or outside the cavity. Linear potentiometers will be mounted on the forks with C-clamps to measure the fork gap variation. Because of mechanical interference, it is not easy to measure cavity ring deflection and we will rely on the gap readout from the potentiometers. During the test, we will measure not only the applied pressure and the fork gap variation, but also the resonant frequency and the loaded and unloaded Q.

The RF measurements have been automated using LabView code and a network analyzer with GPIB interface.

Besides testing the tuning system with all the actuators working as expected, we will also simulate the failure of one or more actuators by isolating their air lines. This will provide knowledge of the limit of the tuning system in case of actuator failure.

## SUMMARY AND PERSPECTIVES

The actuators have been tested intensively and their performances have been validated. A control system based on a LabView code and a PLC has been assembled and it's ready for the test with the cavity. The variation in fork gaps will be measured using linear potentiometers.

Changes in the resonant frequency of the cavity as a function of the applied pressure will be measured. The loaded and unloaded Q will be recorded by an automated program and a network analyzer.

## REFERENCES

- [1] Y.Torun and M. Zisman, "Status of the Muon Ionization Cooling Experiment", THPHO18, NA-PAC'13.
- [2] D. Li et al., "The normal conducting RF cavity for the MICE experiment," EPAC'08, Genova.
- [3] Tianhuan Luo et al., "Progress on the MICE 201 MHz cavity at LBNL", IPAC 2012, New Orleans.
- [4] Y. Torun et al., "Assembly and Testing of the First 201-MHz MICE Cavity at Fermilab", WEPMA16, NA-PAC'13.