

## AN INTERMEDIATE STRUCTURE SFRFQ BETWEEN RFQ AND DTL\*

Y. R. Lu, J. E. Chen<sup>†</sup>, K. Zhu, X. Q. Yan, Z. Wang, Z. Y. Guo,  
M. L. Kang, M. Zhang, J. Zhao, S. L. Gao, S. X. Peng, J. X. Fang  
State Key Lab of Nuclear Physics and Technology, Peking University, 100871

### Abstract

SFRFQ is an intermediate accelerating structure, which combines RFQ and DTL together, it can increase the accelerating efficiency at RFQ exit part by inserting gap acceleration between RFQ electrodes while providing strong focusing by RFQ focusing field. One prototype cavity has been manufactured and been used as a post accelerator of ISR RFQ to accelerate O<sup>+</sup> from 1MeV to 1.6MeV in 1meter. A code SFRFQCODEV1.0 was developed for the beam dynamics design. The RF conditioning and full RF power test has been carried out. The intervane or gap voltage have reached 86kV at 29 kW with 1/6 duty cycle and repetition frequency 166Hz. The initial beam test results will also be presented in this paper. PACS numbers: 29.20.Ej

### INTRODUCTION

RFQ accelerators have been widely used in many applications. Because of increasing of the beam energy, beam accelerating efficiency goes down rapidly. Actually, Longer the RFQ length is, lower kinetic energy gain per unit length is; lower the injection energy of DTL is, much higher accelerating efficiency is; more accelerating gaps at DTL entrance means stronger transverse focusing is needed for the beam. Therefore several different accelerating structures, such as SP RFQ [1] in Russia and RFD [2] in U.S.A., have been studied in last decade to improve accelerating efficiency. The novel idea of Separated Function RFQ (SFRFQ) was first proposed by the RFQ group of IHIP (Institute of Heavy Ion Physics) at Peking university[3], based on the experience of ISR-RFQ 1000 (Integral Split Ring RFQ) [4][5][6]. Initial results of electro-magnetic calculation and dynamics proved the possibility and higher RF accelerating efficiency of SFRFQ structure[7].

To verify accelerating feasibilities of the SFRFQ structure, a simulation code SFRFQCODEV1.0[8] was developed for beam dynamics design. The prototype SFRFQ cavity will be used as a post-accelerator for ISR RFQ-1000 and accelerate O<sup>+</sup> beam with ~mA peak current from 1MeV to 1.6MeV. This paper will present the beam line setup and related experimental results.

### SFRFQ BEAMLINE SETUP

SFRFQ accelerating system consists of a 2.45GHz ECR ion source and LEBT, 1MeV ISR RFQ-1000, Magnetic Triplet, SFRFQ cavity, Analyzing Magnet and three beam Faraday cups. It is shown in Fig.1. Figure 2 shows the

2.45GHz ECR ion source and LEBT. 2.45GHz ECR ion source was made by permanent magnet. It can generate the axial magnetic field of 90~100mT in microwave discharging chamber, which is about 50mm in diameter and 50mm in length. LEBT consists of two electrostatic lenses with diameter of 80mm and 120mm respectively. The total extracted beam current can reach 5mA with extraction voltage 22kV, extraction aperture diameter of 5mm, O<sub>2</sub> gas inlet of 0.15sccm, electrostatic focusing voltage 19.6kV and 16.7kV respectively. The extracted O<sup>+</sup> ratio is about 0.6 and LEBT transmission is about 80%<sup>[9]</sup>. The beam emittance is about 0.12~0.16mm·mrad measured by Allison emittance equipment.

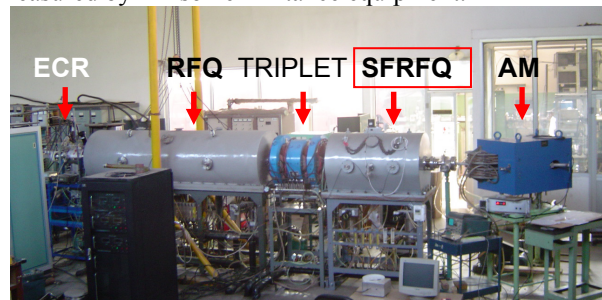

Figure 1: SFRFQ beam line setup.

The triplet has been designed to realize the beam matching in transverse. The figure 2 shows the magnetic gradient distribution along the triplet axis. It is only regret that longitudinal bunched beam length was expanded to nearly 150degree because of beam energy spread and longitudinal drifting. It asks an additional buncher to bunch the beam.

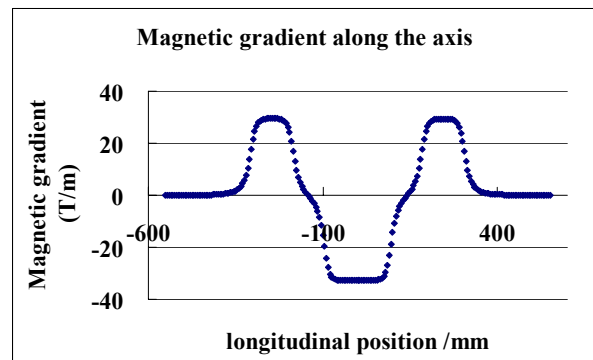

Figure 2: Magnetic gradient along the triplet axis.

The upgrade of beam test for 1MeV ISR-RFQ has been performed. The maximum output peak beam current at RFQ exit i.e. at the entrance of triplet is 2mA with sample

\* Supported by NSFC 10455001

<sup>†</sup> Corresponding author: Chenje@pku.edu.cn

resistor of 1kΩ. This was shown in figure 3. The needed RF power is more than 32.5kW.

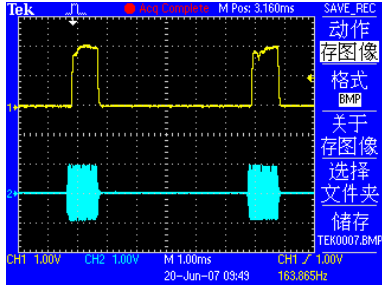

Figure 3: 2mA output peak current for 1MeV ISR RFQ with RF peak power 32.5kW, duty factor 1/6, and RFQ transmission of about 80%.

### SFRFQ AND FULL RF TEST

SFRFQ is a hybrid structure of RFQ and DTL accelerator, the inner structure is shown in figure 4. The RFQ parts are for the transversal alternating gradient focusing, gaps between diaphragms are for acceleration. As we mentioned in last section, the particles' phase are expanded to 150° in triplet drifting. The synchronous phase in SFRFQ should be set gradually from phase -87° to -20° (refer to figure 5). The detailed optimization for SFRFQ cavity design was referenced to [10]. In reference [10], the manufacturing tolerance for inner structure has been also studied very carefully.

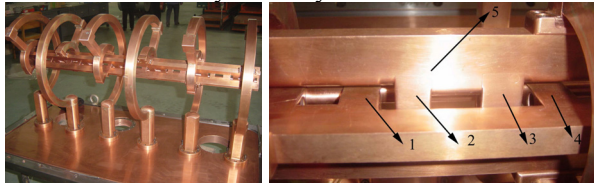

Figure 4: SFRFQ inner structure (left), 1,2,3,4 diaphragms and 5 RFQ electrodes (right).

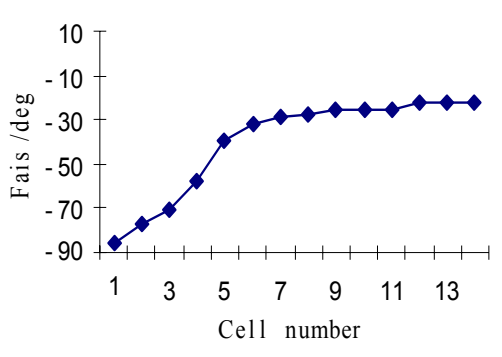

Figure 5: Synchronous phase versus cell number.

A capacitance tuner is installed on the top of tank cover. It has a frequency tuning ability from 26.42MHz to 25.95MHz when it is moved from 0 to depth of 25mm, while the unloaded quality factor goes down from 2480 to 2340. Up to now the capacitance tuner position is controlled by step motor and worked at open loop, because the cavity detuning is about 3 kHz per hour, this is easily controlled manually to decrease the influence of tuning device vibration. The electric field distribution  $E^2$

along the axis was measured by bead pull measurement [10], it fits the field simulation results.

The RF systems, shown in figure 6, consist of two 30kW CW final amplifier made by FU105Z3 which is cooled by circulating distilled water. They can deliver 45kW in pulse mode operation with duty factor 1/6. Each of them includes a 20W (3-30MHz) short wave broadband preamplifier, 1kW driver made by FU100 cooled by air. The electric field gradient in the cavity is stabilized by an AGC feedback system independently. The RF system for SFRFQ cavity includes a voltage controlled phase shifter [10], it can control the RF field phase in SFRFQ cavity and keep it be synchronous with the particles. The shifted phase versus controlled voltage is shown in figure 7. The voltage standing wave ratio is less than 1.1 under the RF power test. The principal parameters for RFQ cavity can be referenced in [6], and that for SFRFQ is listed in Table 1. The RF test results are listed in Table 2. TABLE II lists the results of RF power test with the duty factor 1/6. Here  $V_0$  is the intervane

voltage,  $\rho = \frac{V_0^2}{p} \cdot l$  is the specific shunt impedance,

where  $p$  and  $l$  is the RF power and length of the cavity. Figure 8 gives an example of intervane voltage measurement by using high purity Ge detector. The specific shunt impedance is about 270.8kΩm.

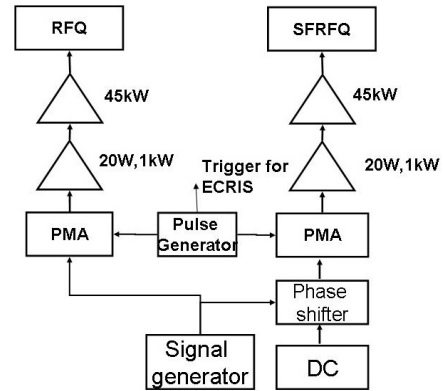

Fig. 6 RF system

Table 1: Principal Parameters of SFRFQ

	Prototype
Ion species	O <sup>+</sup>
F(MHz)	26.07
W <sub>in</sub> (keV)	1000
W <sub>out</sub> (keV)	1620
Cavity Length(cm)	105.8
Diameter(cm)	70
V <sub>0</sub> (kV)	70
Duty factor	1ms/6ms

Table 2: The Results of SFRFQ RF Power Test

Power/kW	$V_0$ /kV	$\rho$ /k $\Omega$ ·m
16.2	65.81	276.2
20.7	73.16	265.7
23.4	78.06	269.8
28.8	86.22	266.6
33.3	91.02	257.1

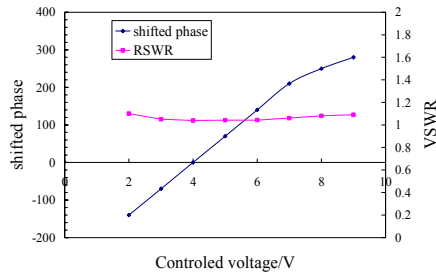

Figure 7: Shifted phase versus control voltage.

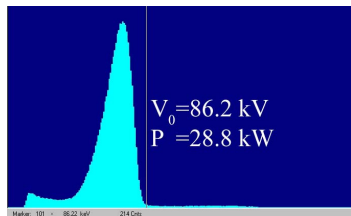

Figure 8: Roentgen spectrum at 28.8 kW RF powers.

## INITIAL BEAM TEST

Because 1MeV ISR RFQ has no frequency tuning system, RF test for total accelerating system is rather difficult at the beginning of RF conditioning. At first nearly 35kW pulse power with duty cycle of 1/6 at 166Hz repetition frequency is feed into RFQ cavity, several minutes later, and the cooling water temperature of RFQ cavity has balanced with RF feeding power. The RFQ frequency finally is kept at 26.075MHz. This is actually the working point of SFRFQ. This fits the impedance matching (figure 9) of in-coupling loop. After feeding about 20kW into SFRFQ cavity, and changing controlled voltage of phase shifter to 4.9V, setting triplet coils currents to 65A,47.5A and 65A respectively, the first beam comes at the SFRFQ exit, it is nearly about 162 $\mu$ A. The energy spectrum of output beam is also measured by analysing magnets. The maximum beam current is corresponding to the beam energy of 1.86MeV. It is rather higher than the designed 1.62MeV. The energy spectrum will be calibrated by nuclear reaction and beam transport will be optimized in the further experiments.

## CONCLUSION

Initial results show the SFRFQ cavity can have higher acceleration efficiency and can also stand 91kV intervane voltage. Although the output beam energy is higher than the designed value and output beam current is not yet

good optimized for the final operation. The RF synchronous phase and RF power level will greatly influence the output beam current and beam energy. The triplet parameters have also great influence on the beam transport.

The authors would like to thank Prof.Dr.Klein and Prof.U.Ratzinger for their helpful discussions about H type DTL linac.

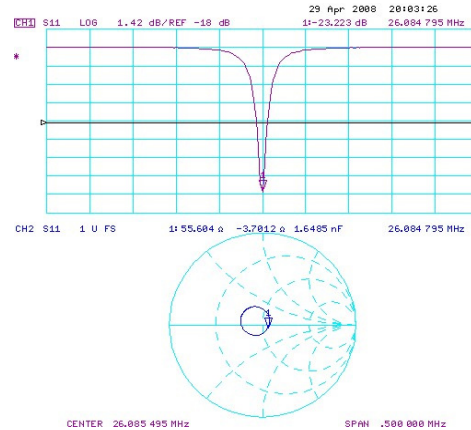
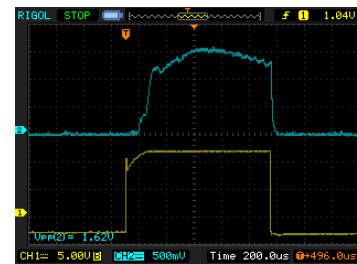

Figure 9: The Impedance Matching of RF Feeder.

Figure 10: Output Macro-pulse Beam Current (sample resistor 10k $\Omega$ ).

## REFERENCE

- [1] S.Minaev, Nuclear Instruments and Methods in Physics Research, a, Issue: 1-3, August 21, 2002, pp. 45-58
- [2] D.A.Swenson, et al., Proceedings of the 1998 LINAC Conference, Chicago, IL, 1998, p. 648
- [3] C.E.Chen, J.X. Fang, et al. Progress on Natural Science, Vol. 12, No.1, 23, 2002
- [4] C.E.Chen, J.X. Fang, et al., Proc. of EPAC 1994
- [5] Y.R.Lu, J.F.Guo, et al., NIMA, 420 (1999)
- [6] Y.R.Lu, C.E.Chen, J.X.Fang, et al. NIMA, A515(2003): 394-403
- [7] X.Q.Yan, J.X. Fang, et al., Nuclear Inst. and Methods in Physics Research, A, 506(1-6)
- [8] Z. Wang, et al, NIMA, 572,2007,596-600
- [9] S.X.Peng, M.Zhang et al., Review of Scientific Instrument, 79, 02B706 \_2008, DOI: 10.1063/1.2802200
- [10] Z. Wang, Peking university dissertation, 2008
- [11] Lu Yuanrong, W Gutowski, Acta Scientiarum Naturalium Universitatis Pekinensis, Vol.38, No.1, P. 49-56, (Jan,2002)