

HIGH FIELD MAGNET DEVELOPMENT TOWARD THE HIGH LUMINOSITY LHC*

G. Apollinari, Fermi National Accelerator Laboratory, Batavia U.S.A.

Abstract

As part of the High Luminosity Large Hadron Collider (HL-LHC) project, a series of activities aimed at the design, development and construction of Nb₃Sn dipoles and quadrupoles with appropriate accelerator qualities were initiated. A new series of quadrupoles with 150 mm bore and a gradient of 140 T/m will provide the final beam focusing for the CMS and ATLAS Interaction Regions. In addition, Nb₃Sn 11 T dipoles will replace, in few location, the main 8.3 T dipoles to allow the insertion of additional collimators needed for HL-LHC operations.

INTRODUCTION

The LHC has been operated up to the energy of 8 TeV in the Center of Mass (CM) and up to 70% of the nominal luminosity in 2012. Starting in 2015, it will provide ~300 fb⁻¹ of integrated luminosity by 2022 to both CMS and ATLAS at 13-14 TeV CM. After that date, the doubling time to reduce statistical errors and perform rare physics searches will become prohibitively long and therefore a plan for a luminosity upgrade (HL-LHC) aimed at collecting ~3000 fb⁻¹ per experiment in the following 10 years has been proposed [1].

The detector-driven requirements on useful luminosity delivered by the HL-LHC can be summarized in the following way:

- Increase the luminosity limiting the Pile-Up to ~140 events/crossing up to a value of $L=5 \times 10^{34} \text{ cm}^{-2}\text{s}^{-1}$.
- Limit the PU linear (longitudinal) density to ~1 event/mm

These requirements can be met with the coordinated use of High Field Magnets (needed to reduce by a factor of two the beam size at the interaction point) and Crab Cavities designed to kick the beam buckets in the horizontal and vertical planes. This paper summarizes the progress achieved so far in the development of High Field Magnets for the HL-LHC Project.

INTERACTION REGION QUADRUPOLES

In summer 2012, as a baseline scenario for HL-LHC, it was decided to choose a low-β quadrupole design based on Nb₃Sn technology [2]. The new Interaction Region (IR) quadrupole focusing magnets, called QXF, will be developed in a collaborative effort between the US LHC Accelerator R&D Program (LARP) and CERN. The new layout of the IR is shown in Fig. 1.

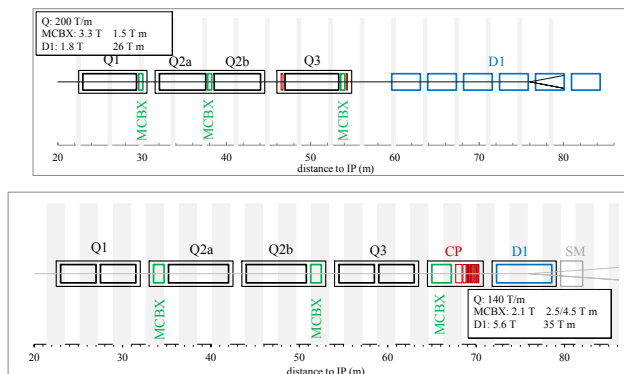

Figure 1: Layout of magnetic elements in the present LHC (top) and HL-LHC (bottom).

Design Constraints

Radiation damage and heat deposition, proportional respectively to integrated and peak luminosity, are the two major constraints in the design of a magnetic system for final focusing.

Some essential components employed for magnet fabrication (epoxy resins) undergo severe degradation at 50-100 MGy. A safe dose limit for the IR HL-LHC is set at 10-20 MGy. In terms of heat deposition, it has been shown [3] that heat deposition is manageable if it can be maintained below a limit of 12 mW/cm³ in Nb₃Sn.

Simulations show that shielding is a very effective way to limit radiation damage and heat deposition: with a 6-mm-thick tungsten shielding, one can bring them down to values of ~40 MGy and 4 mW/cm³ [4] respectively. Using additional shielding one can further reduce these values as shown in Fig. 2.

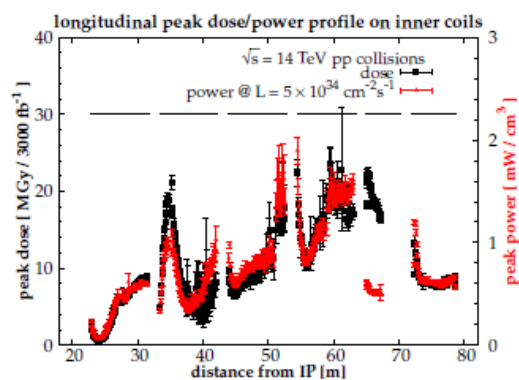

Figure 2: Heat deposition in the coil (left scale) and radiation damage (right scale) for 150 mm aperture triplet.

Field quality constraints are also very tight when beam are brought in collision since the beta functions are extremely large (~20 km) in the interaction region quadrupoles.

*Work supported by the European Commission under the FP7 project HiLumi LHC, GA 284404, from the High Energy Physics Division, U. S. Department of Energy, under Contract DE-AC02-07CH11359

Coil Design

To a first approximation in a superconducting magnet the field is proportional to the current density in the coil. The increased aperture and - therefore - higher field on the coils for comparable gradients push for the use of the Nb₃Sn technology.

In order to manage the large mechanical stresses induced by electromagnetic forces and to protect the magnet in a transition to the resistive state (quench), current densities in the coils much larger than 500 A/mm² need to be avoided. The proper balance is found for a coil width of ~35 mm providing an operational gradient of ~140 T/m [5]. The coil cross-section is shown in Fig. 3

Superconductor Choice and Specifications

Presently, two options are being considered for the basic superconducting strand. The RRP design (Restack Rod Process) developed by Oxford Superconducting Technology [6] in collaboration with the US Conductor Development Program, and the PIT design (Powder In Tube) by Shape Metal Innovation (now part of Bruker-EAS). The basic strand specification is shown in Table 1.

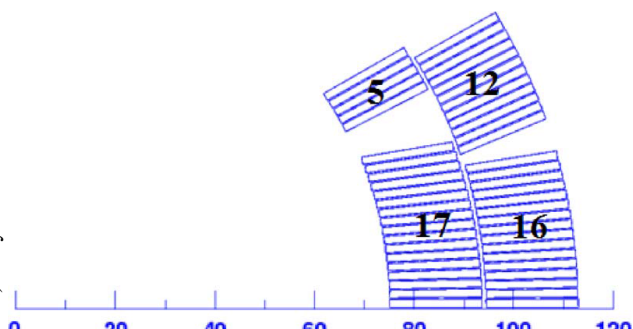

Figure 3: Octant of the QXF quadrupole coil. The number of cables in each block is also indicated.

Table 1: Nb₃Sn Strand Specifications

Strand Diameter, mm	0.85 +/- 0.003
I _c (15T) at 4.2 K, A	>361
n-value	> 30
D _s , μm (sub-element diameter)	< 50
Cu:non-Cu Volume Ratio	1.2 +/- 0.1
RRR (after full reaction)	>150
Twist Pitch, mm	19 +/- 3
Twist Direction	Right-hand screw
Strand Spring-back, deg	< 720
Magnetization Width at 3T, 4.2 K, mT	< 300
High Temperature HT duration, h	> 48

A Rutherford-type cable has been designed for QXF. It is made of 40 0.85 mm diameter strands [7] and incorporates a 12 mm × 25 μm stainless-steel core to

control the ramp rate effect [8]. The width, mid-thickness and keystone angle accommodate for the cos2θ-type design. Because of the phase transformation occurring during Nb₃Sn formation the cable is expected to expand during reaction by 4.5% in thickness and 2% in width [9]. The cable insulation is 150 μm thick (under a pressure of 5 MPa) and is realized with S2-glass yarns directly braided on the cable.

Development History

Since 2004, four US laboratories (BNL, FNAL, LBNL and SLAC) have been working, within the framework of the DOE-funded LARP, on the development of Nb₃Sn quadrupoles for future upgrades of the LHC IRs [10].

Various models and prototypes build by LARP and identified in Fig. 4 proved different aspects of the technology, from the manufacturing and reproducibility of the cos2θ design (TQ series [11]) to the development of a mechanical structure with an external shell preloaded with water-pressurized bladders (TQS series [12]) to the length scale-up (LQ series [13,14]) to the increase in aperture and optimization of accelerator quality features (HQ series [15-18]). Figure 5 shows the quench performance achieved in the latest HQ02 magnet.

Presently, the HQ series is used to establish and study quench protection performance before the availability of the first QXF short models in 2015.

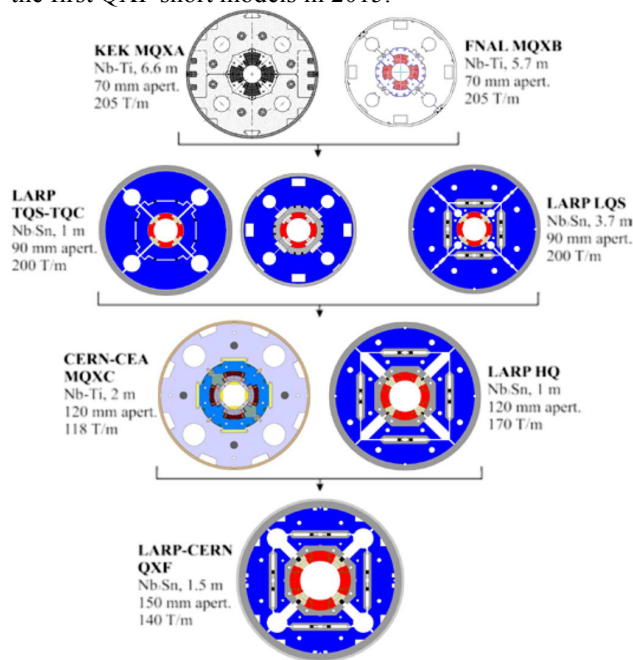

Figure 4: Overview of low-β quadrupole developments.

Quench Protection Experience

Protection is a critical aspect of magnet development. The total inductance of the QXF triplet is of the order of ~200 mH. With currents of the order of 15 kA a dump resistor cannot be larger than 50 mΩ in order to limit the voltage, and time constants of the circuit—in absence of significant resistance of the magnet—range from 3 to 5 s. This implies that quench heaters have to be used to

increase the resistance of the circuit, speed up the current decay and dissipate the energy in a larger coil volume.

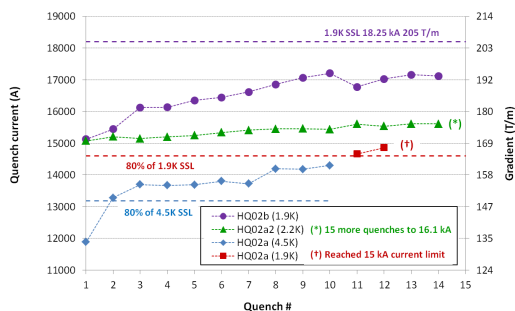

Figure 5: Quench performance of HQ02, reaching 95% of the Short Sample Limit.

The quench heaters design includes inner layer quench heaters located between the coil and the beam pipe. These heaters – not being supported on the inner side - might detach with the thermal strains induced by quench and consequently lose their efficiency.

For these reasons, a special campaign of protection studies has been carried out on HQ to check the possibility of protection without dump resistor and without inner layer quench heaters (see [17] for more details). The results indicate that protection without inner layer heater and without dump resistor may be viable, but might bring the hot spot to temperatures of ~300 K. The conclusion is that protection parameters should not be made worse than in HQ, and possibly improved.

QXF Plans

LARP and CERN plans calls for the construction of the first 150 mm aperture Short (1.5 m) QXF models by Summer 2015, and of the first Long QXF prototypes by Fall 2016. Procurements of tooling and materials are presently taking place.

11T DIPOLES

LHC particles losing momentum due to interactions in the IRs or diffractive scattering can only be intercepted in the high Dispersion Suppression (DS) regions. In order to install additional collimators in the DS regions, 11 T Nb₃Sn dipoles are considered as replacements for several 8.33 T LHC main NbTi dipoles delivering the same integrated strength at the nominal LHC current. To demonstrate the feasibility of this approach, CERN and FNAL initiated an R&D program to develop a 5.5 m long twin-aperture Nb₃Sn dipole.

11 T Dipole Experience

The design of the 11 T Nb₃Sn dipoles in single aperture and twin-aperture configuration is described in [19,20]. The magnet coil was optimized to provide a dipole field above 11 T in a 60 mm aperture at the 11.85 kA current with 20% margin, and geometrical field errors below 10⁻⁴. Figure 6 shows cross-section designs of coil and magnets.

The program started with the design and construction of a 2 m long single-aperture Nb₃Sn demonstrator magnet

(MBHPS01) that was tested at FNAL in June 2012 and reached 10.4 T at the LHC operating temperature of 1.9 K [21,22]. To improve the magnet quench performance and field quality, as well as to demonstrate performance reproducibility, the fabrication of four 1 m long collared coils was started at FNAL resulting in the assembly of a 1 m long dipole (MBHSP02), a 1 m long coil tested in the mirror configuration ((MBHSM01) and a second 1 m long dipole (MBHSP03).

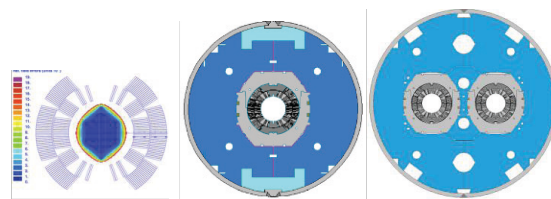

Figure 6: The 2-layer coil (left), single aperture (middle) and twin-aperture (right) dipole cold masses. The dark area in the coil corresponds to relative field errors below 10⁻⁴.

The quench performance of these magnets is shown in Fig. 7. All the tested magnets show quite long magnet training. Both 1 m long dipole models MBHSP02 and MBHSP03 were trained above the nominal field of 11 T to 11.7 and 11.2 T respectively. The large quench current degradation observed in MBHSP01 and MBHSP02 has been reduced in MBHSM01 and MBHSP03 thanks to coil pre-load optimization [23,24].

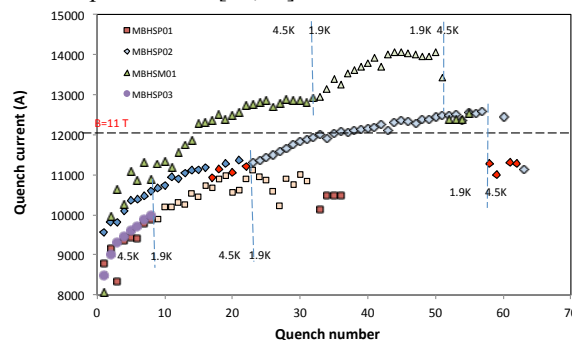

Figure 7: Summary of 11 T magnets trainings.

Accurate field quality studies performed on MBHSP02 [25] show that the geometrical harmonics in the magnet straight section are being reduced by optimizing the coil cross section. Nevertheless, some low-order field harmonics are still relatively large due to the deviations of "as-built" coil geometry from the design cross section.

CONCLUSION

The first application of Nb₃Sn conductor to accelerator quality magnets is foreseen in the IR quadrupoles and the 11 T dipoles for the HL-LHC upgrade.

The status of development for these two types of magnets has been described in this paper. Various models and prototypes are showing good progress on all fronts and bid well for the usage of these magnets in HL-LHC.

REFERENCES

- [1] L. Rossi, O. Bruning, "High Luminosity Large Hadron Collider: A Description for the European Strategy Preparatory Group," CERN, Geneva, Switzerland, CERN ATS 2012-236, p. 23 (2012).
- [2] E. Todesco et al., "A First Baseline for the Magnets in the High Luminosity LHC Insertion Regions," IEEE Trans. Appl. Supercond. 24(3), 4003305 (2014).
- [3] V. V. Kashikhin et al., "Quench Margin Measurement in Nb₃Sn Quadrupole Magnet", IEEE Trans. Appl. Supercond. 19, 2454 (2009).
- [4] L. Esposito et al., "Fluka energy deposition studies for the HL-LHC, Proceedings of IPAC13, 1379-1381.
- [5] F. Borgnolutti et al., "Magnetic Design Optimization of a 150 mm Aperture Nb₃Sn Low-Beta Quadrupole for the HiLumi LHC", IEEE Trans. Appl. Supercond. 24(3), 4000406 (2014).
- [6] J. A. Parrell et al., "High Field Nb₃Sn Superconductor Development at Oxford Superconducting Technology," IEEE Trans. Appl. Supercond. 13(2), 3470 (2003).
- [7] D. Dietderich, "Optimization of Nb₃Sn Cable for the LARP 150 mm Lowbeta High-gradient Quadrupole Magnet for HiLumi," presented at the 23rd Int. Conf. Magn. Technol., Boston, MA, USA, 2013, oral presentation.
- [8] X. R. Wang et al., "Magnetic measurements of LARP HQ01 Magnet," Lawrence Berkeley Nat. Lab., Berkeley, CA, USA, BNL report 5290E, Dec. 2012.
- [9] H. Felice, "Impact of coil compaction on Nb₃Sn LARP HQ magnet", IEEE Trans. Appl. Supercond. 22(3), 4001904, (2012).
- [10] S.A. Gourlay et al., "Magnet R&D for the US LHC Accelerator Research Program," IEEE Trans. Appl. Supercond. 16(2), 324 (2006).
- [11] P. Ferracin, "LARP Nb₃Sn Quadrupole Magnets for the LHC Luminosity Upgrade" in Proc. AIP Conf., 1218, 1291 (2010).
- [12] S. Caspi et al., "Design and Analysis of TQS01, a 90 mm Nb₃Sn Model Quadrupole for LHC Luminosity Upgrade Based on a Key and Bladder Assembly" IEEE Trans. Appl. Supercond. 16(2), 358 (2006).
- [13] G. Ambrosio et al., "Development and Coil Fabrication for the LARP 3.7-m long Nb₃Sn quadrupole," IEEE Trans. Appl. Supercond. 19(3), 1231 (2009).
- [14] P. Ferracin et al., "Fabrication and Test of a 3.7 m Long Support Structure for the LARP Nb₃Sn Quadrupole Magnet LQS01," IEEE Trans. Appl. Supercond. 19(3), 1683 (2009).
- [15] S. Caspi et al., "Test results of 15 T Nb₃Sn quadrupole magnet HQ01 with a 120 mm bore for the LHC luminosity upgrade," IEEE Trans. Appl. Supercond. 21(3), 1854 (2011).
- [16] H. Felice et al., "Impact of Coil Compaction on Nb₃Sn LARP HQ Magnet," IEEE Trans. Appl. Supercond. 22(3), 4001904 (2012).
- [17] H. Bajas et al., "Cold Test Results of the LARP HQ Nb₃Sn Quadrupole Magnet at 1.9 K," IEEE Trans. Appl. Supercond. 23(3), 4002606 (2013).
- [18] G. Chlachidze et al., "Performance of HQ02, an Optimized Version of the 120 mm Nb₃Sn LARP Quadrupole," IEEE Trans. Appl. Supercond. 23(3), 4003805 (2014).
- [19] A. V. Zlobin et al., "Development and test of a single-aperture 11 T Nb₃Sn demonstrator dipole for LHC upgrades," IEEE Trans. Appl. Supercond. 23(3), 4000904 (2013).
- [20] M. Karppinen et al., "Design of 11 T twin-aperture Nb₃Sn dipole demonstrator magnet for LHC upgrades," IEEE Trans. Appl. Supercond. 22(3), 4901504 (2012).
- [21] A. Zlobin et al., "Development of Nb₃Sn 11 T Single Aperture Demonstrator Dipole for the LHC Upgrades", Proceeding of PAC2011, NYC, 1460, (2011).
- [22] A. Zlobin et al., "Development and Test of a Single-Aperture 11 T Nb₃Sn Demonstrator Dipole for the LHC Upgrades", IEEE Trans. Appl. Supercond. 23, 4000904 (2013).
- [23] A. Zlobin et al., "Quench Performance of a 1 m Long Single-Aperture 11 T Nb₃Sn Dipole Model for the LHC Upgrades", IEEE Trans. Appl. Supercond. 24(3), 400305 (2014) and references therein.
- [24] A.V. Zlobin et al., "Status of the 11 T 2-in-1 Nb₃Sn Dipole Development for LHC", IPAC'2014, Dresden, June 2014.
- [25] G. Chlachidze et al., "Field Quality Study of a 1 m Long Single-Aperture 11 T Nb₃Sn Dipole Model for the LHC Upgrades", IEEE Trans. Appl. Supercond. 24(3), 400905 (2014).