

# The *PEPPo* Concept for a Polarized Positron Source

*Polarized Electrons for Polarized Positrons*

**Eric Voutier** on behalf of the PEPPo Collaboration

*Laboratoire de Physique Subatomique et de Cosmologie  
Grenoble, France*

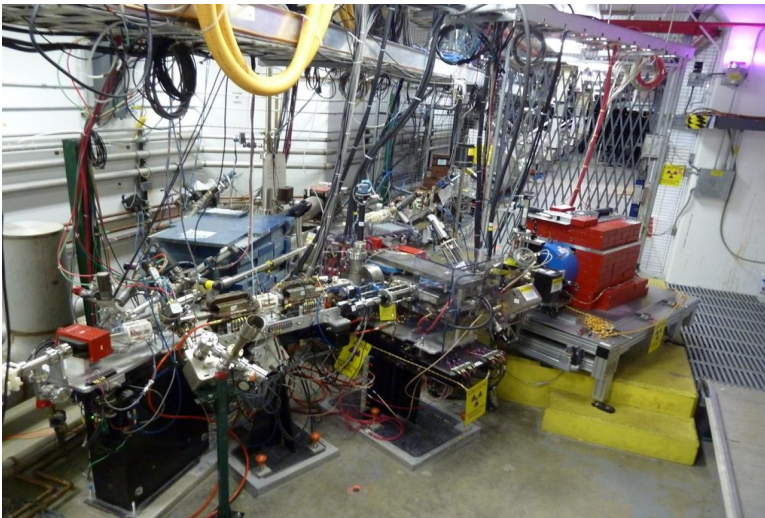

- (i) Polarized positron production
- (ii) Experimental setup
- (iii) Commissioning
- (iv) Operation
- (v) Preliminary data

## Polarized Bremsstrahlung

E.G. Bessonov, A.A. Mikhailichenko, EPAC (1996)    A.P. Potylitsin, NIM A398 (1997) 395

PEPPo has **studied** the feasibility of using **bremsstrahlung** from **polarized electrons** for the production of **polarized positrons**.

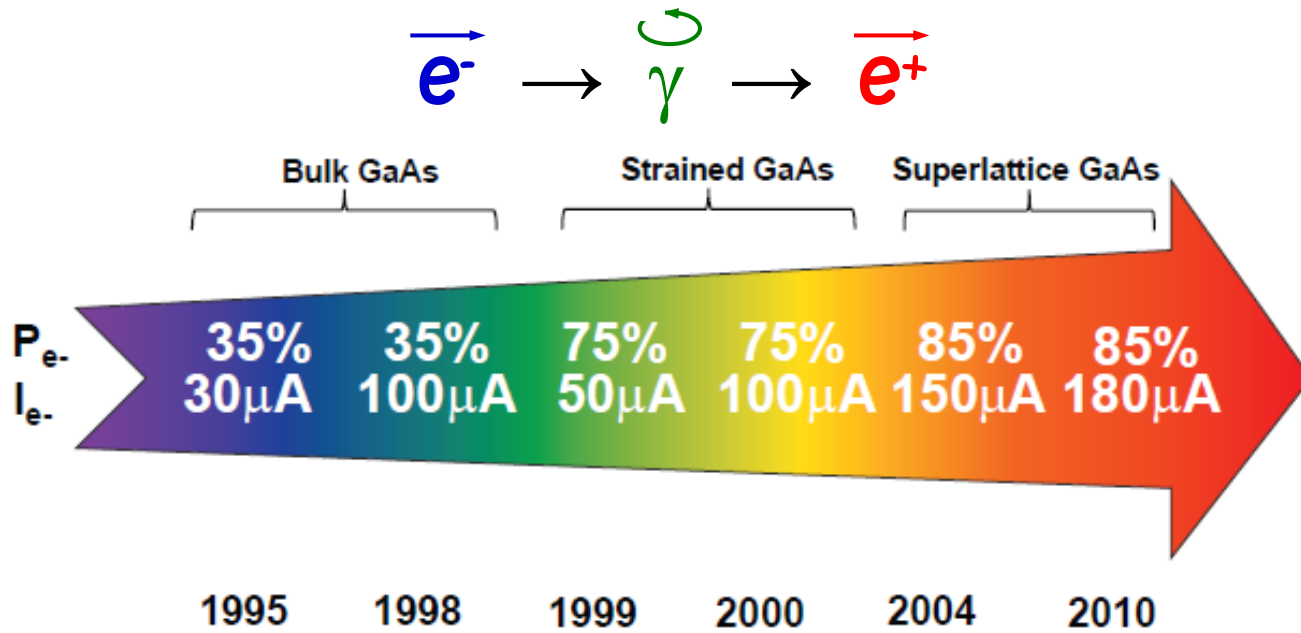

Sustainable polarized electron intensities up to **4 mA** have been demonstrated from a superlattice photocathode.

R. Suleiman et al., PAC'11, New York (NJ, USA), March 28 - April 1, 2011

# Polarization Transfer in Bremsstrahlung and Pair Production

H. Olsen, L. Maximon, PR 114 (1959) 887

E.A. Kuraev, Y.M. Bystritskiy, M. Shatnev, E. Tomasi-Gustafsson, PRC 81 (2010) 055208

## BREMSSTRAHLUNG

## PAIR CREATION

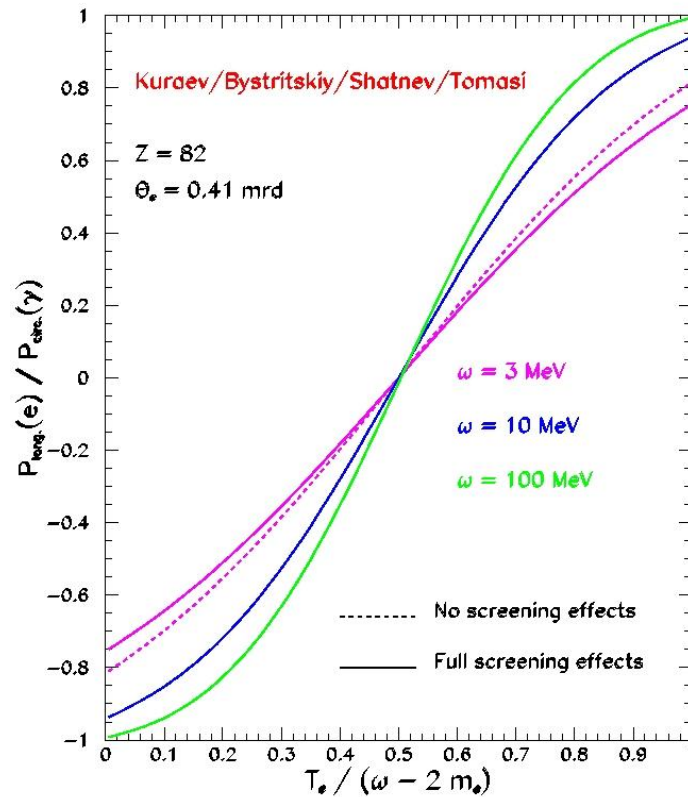
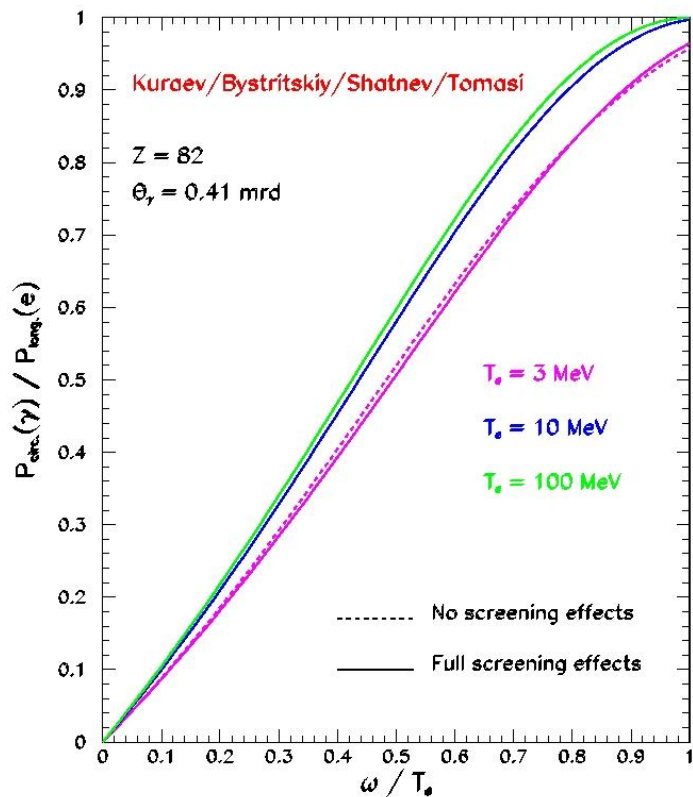

**Principle of Operation**

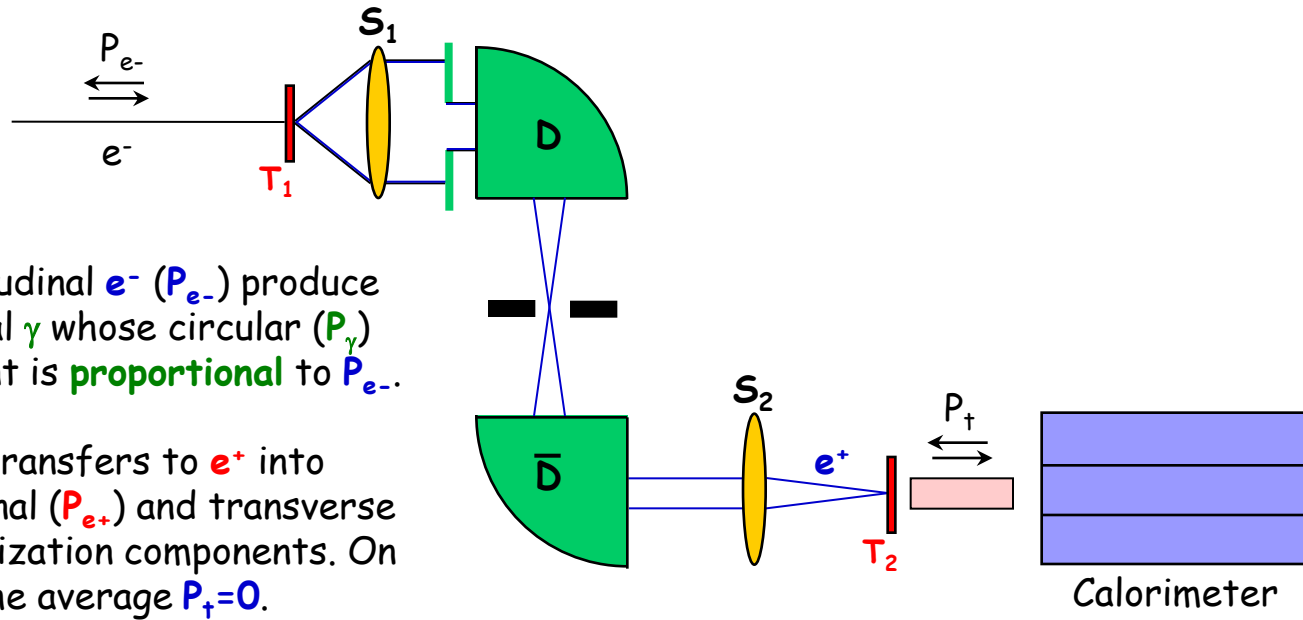

o Longitudinal  $e^-$  ( $P_{e^-}$ ) produce elliptical  $\gamma$  whose circular ( $P_\gamma$ ) component is proportional to  $P_{e^-}$ .

o  $P_\gamma$  transfers to  $e^+$  into longitudinal ( $P_{e^+}$ ) and transverse ( $P_+$ ) polarization components. On the average  $P_+=0$ .

## Principle of Operation

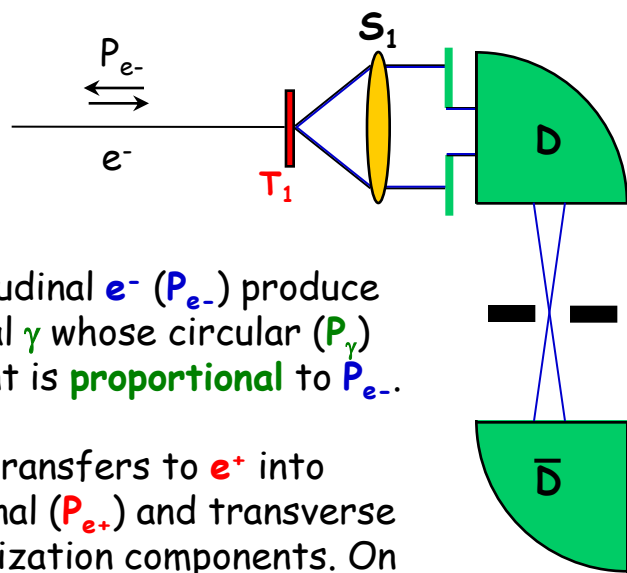

o Longitudinal  $e^-$  ( $P_{e^-}$ ) produce elliptical  $\gamma$  whose circular ( $P_\gamma$ ) component is **proportional** to  $P_{e^-}$ .

o  $P_\gamma$  transfers to  $e^+$  into longitudinal ( $P_{e^+}$ ) and transverse ( $P_\perp$ ) polarization components. On the average  $P_\perp=0$ .

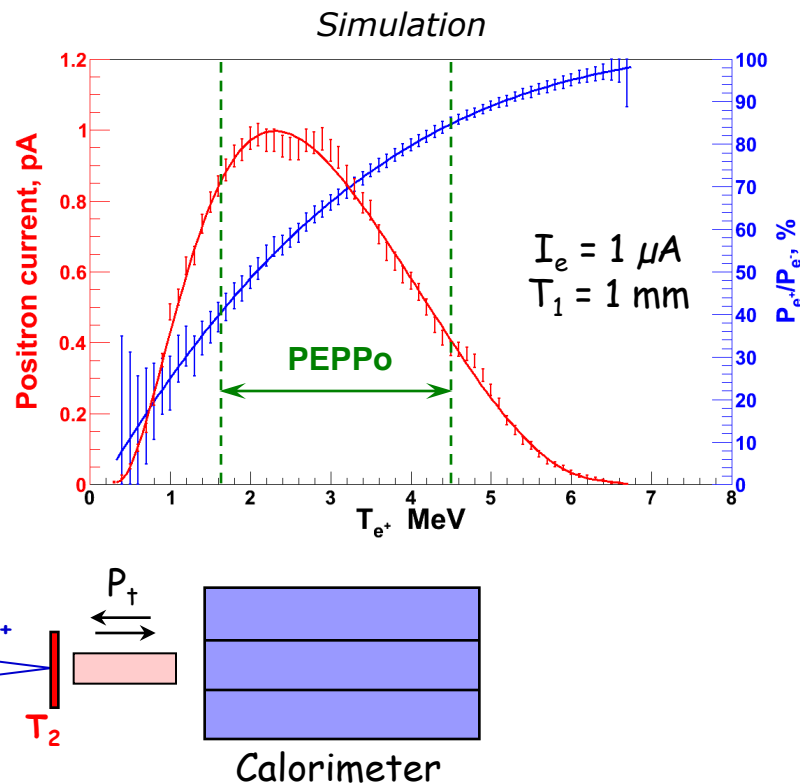

**PEPPo** measured the **polarization transfer** from longitudinal electrons to longitudinal positrons in the **3-6 MeV/c momentum range**.

## Experiment Layout

- PEPPo ran at the CEBAF **injector**, taking advantage of the existing **beam diagnostics** that **determine** with **precision** the properties of the **polarized electron beam** entering the PEPPo apparatus.

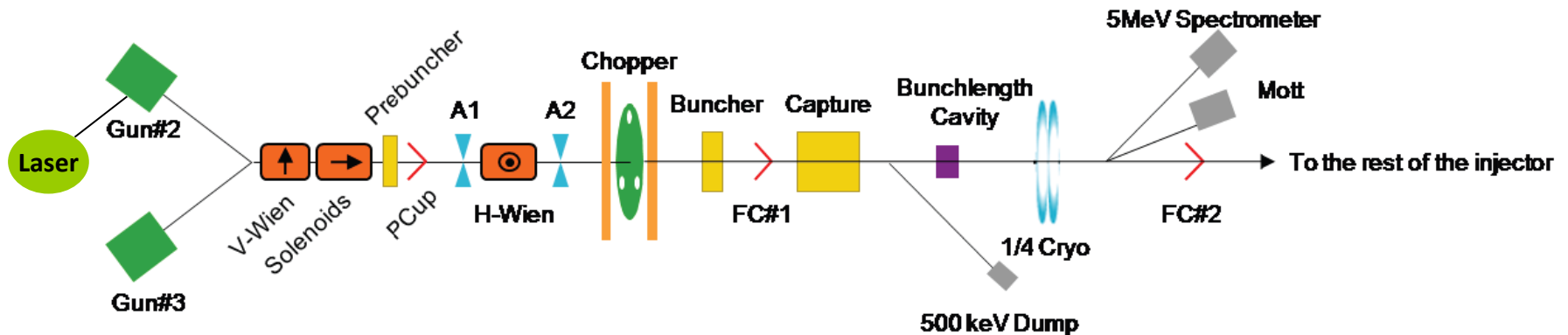

## Experiment Layout

- PEPPo ran at the CEBAF **injector**, taking advantage of the existing **beam diagnostics** that **determine** with **precision** the properties of the **polarized electron beam** entering the PEPPo apparatus.

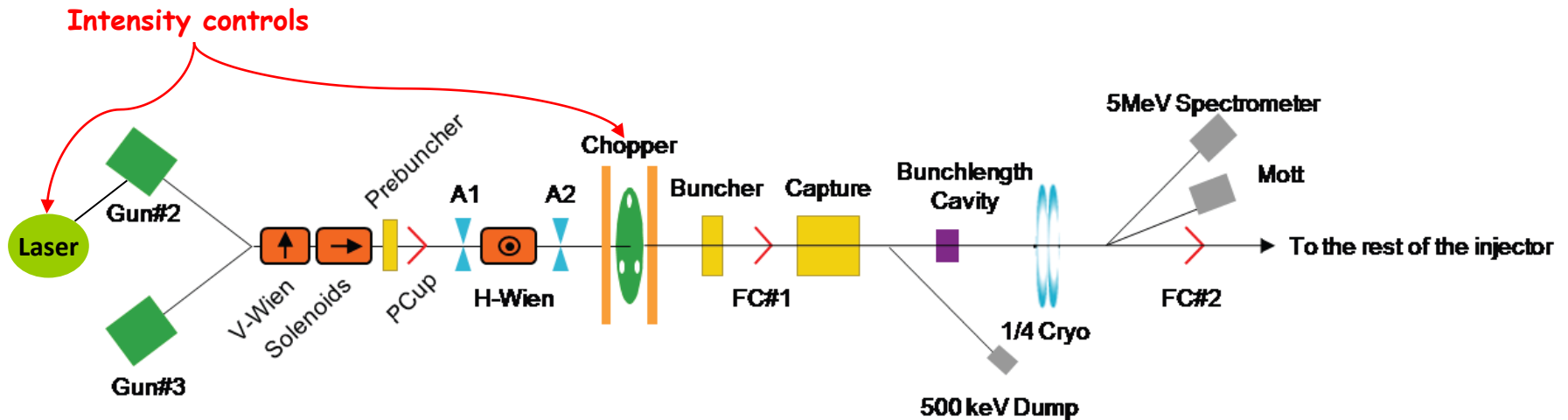

# Experiment Layout

- PEPPo ran at the CEBAF injector, taking advantage of the existing **beam diagnostics** that **determine** with **precision** the properties of the **polarized electron beam** entering the PEPPo apparatus.

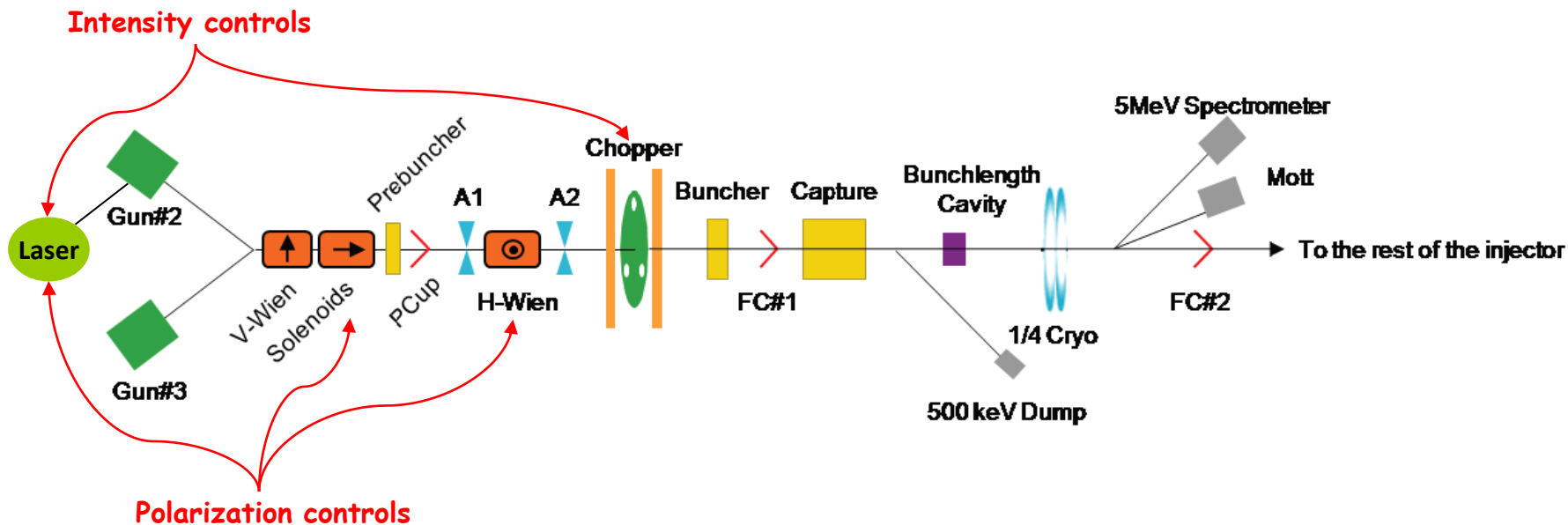



## Experiment Layout

- PEPPo ran at the CEBAF injector, taking advantage of the existing **beam diagnostics** that **determine** with **precision** the properties of the **polarized electron beam** entering the PEPPo apparatus.

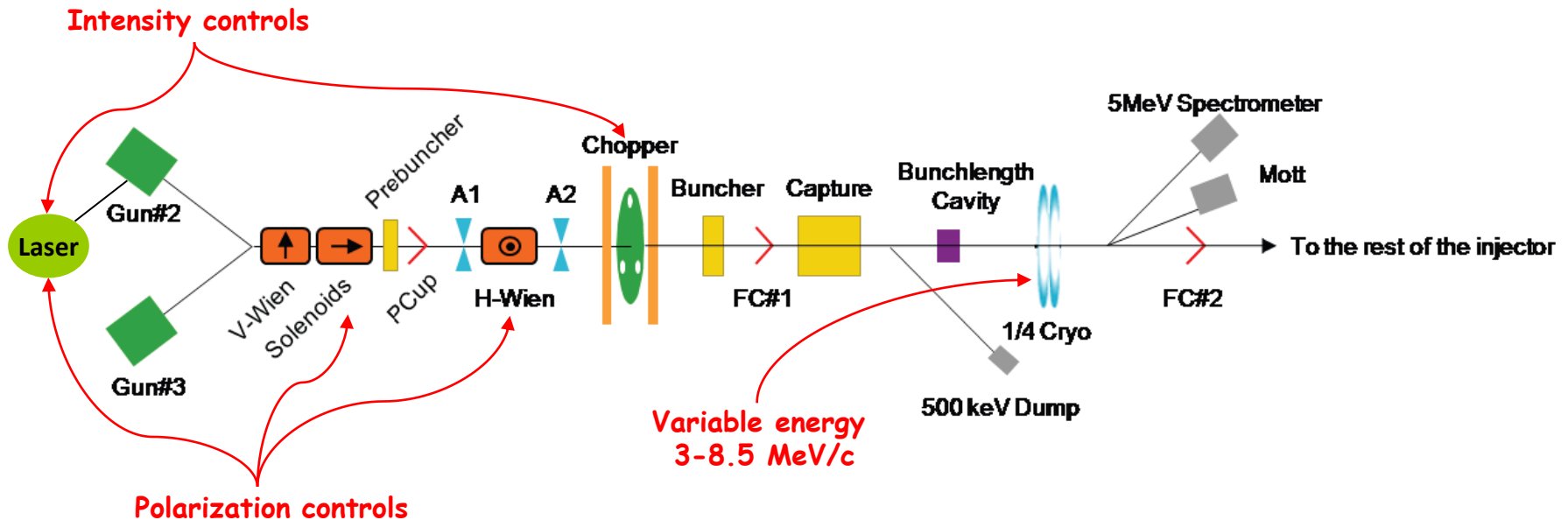

# Experiment Layout

- PEPPo ran at the CEBAF injector, taking advantage of the existing **beam diagnostics** that **determine** with **precision** the properties of the **polarized electron beam** entering the PEPPo apparatus.

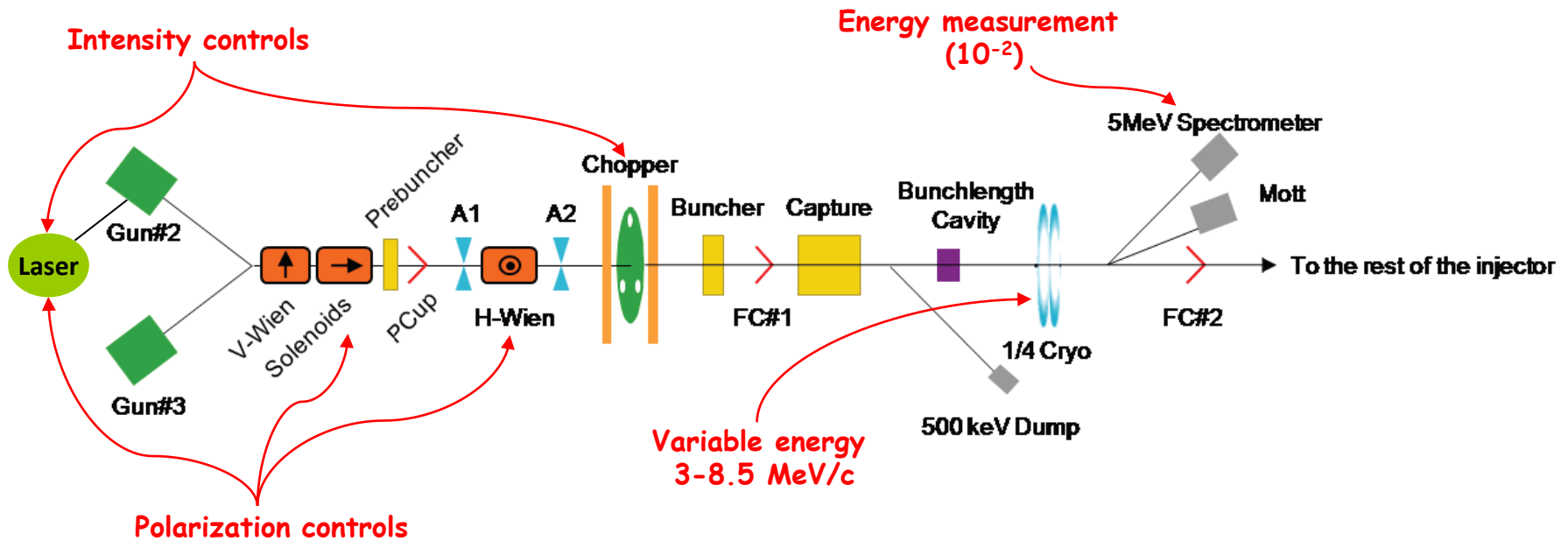

# Experiment Layout

- PEPPo ran at the CEBAF injector, taking advantage of the existing **beam diagnostics** that **determine** with **precision** the properties of the **polarized electron beam** entering the PEPPo apparatus.

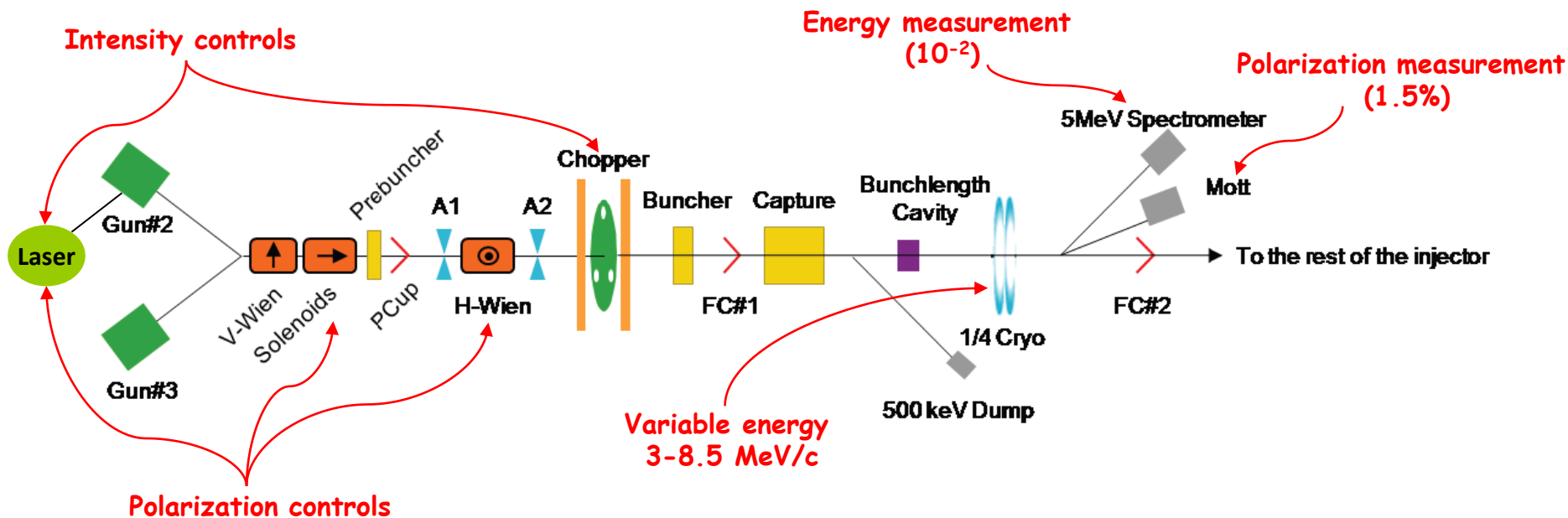

# Experiment Layout

- PEPPo ran at the CEBAF injector, taking advantage of the existing **beam diagnostics** that **determine** with **precision** the properties of the **polarized electron beam** entering the PEPPo apparatus.

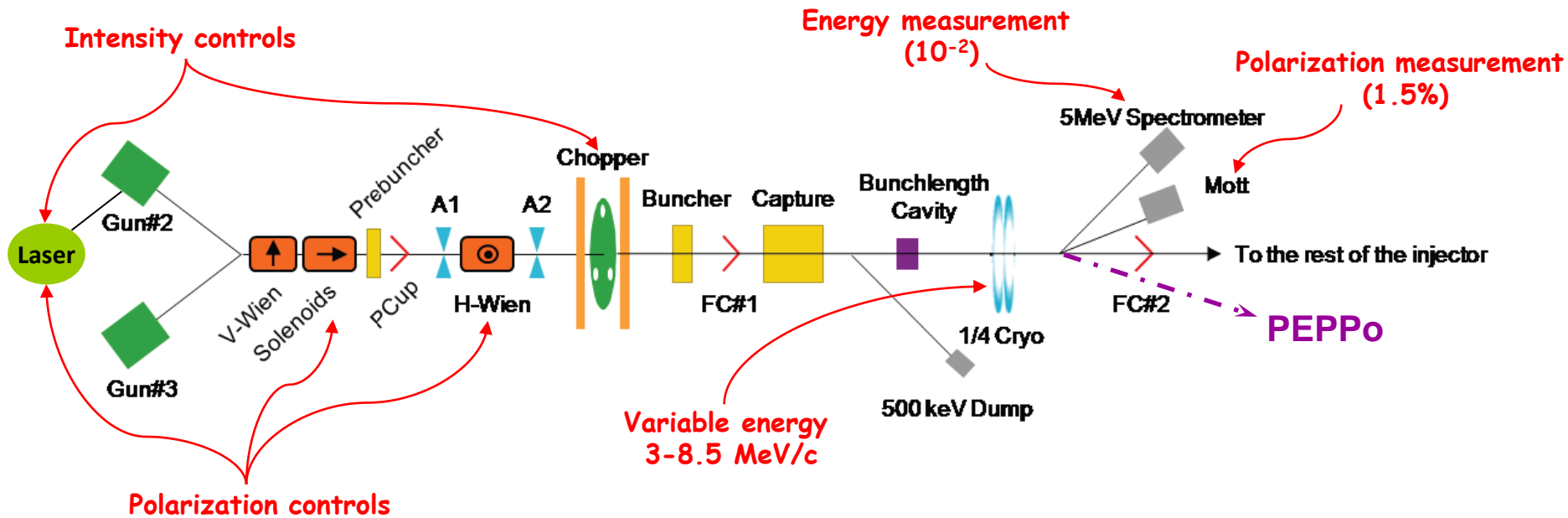

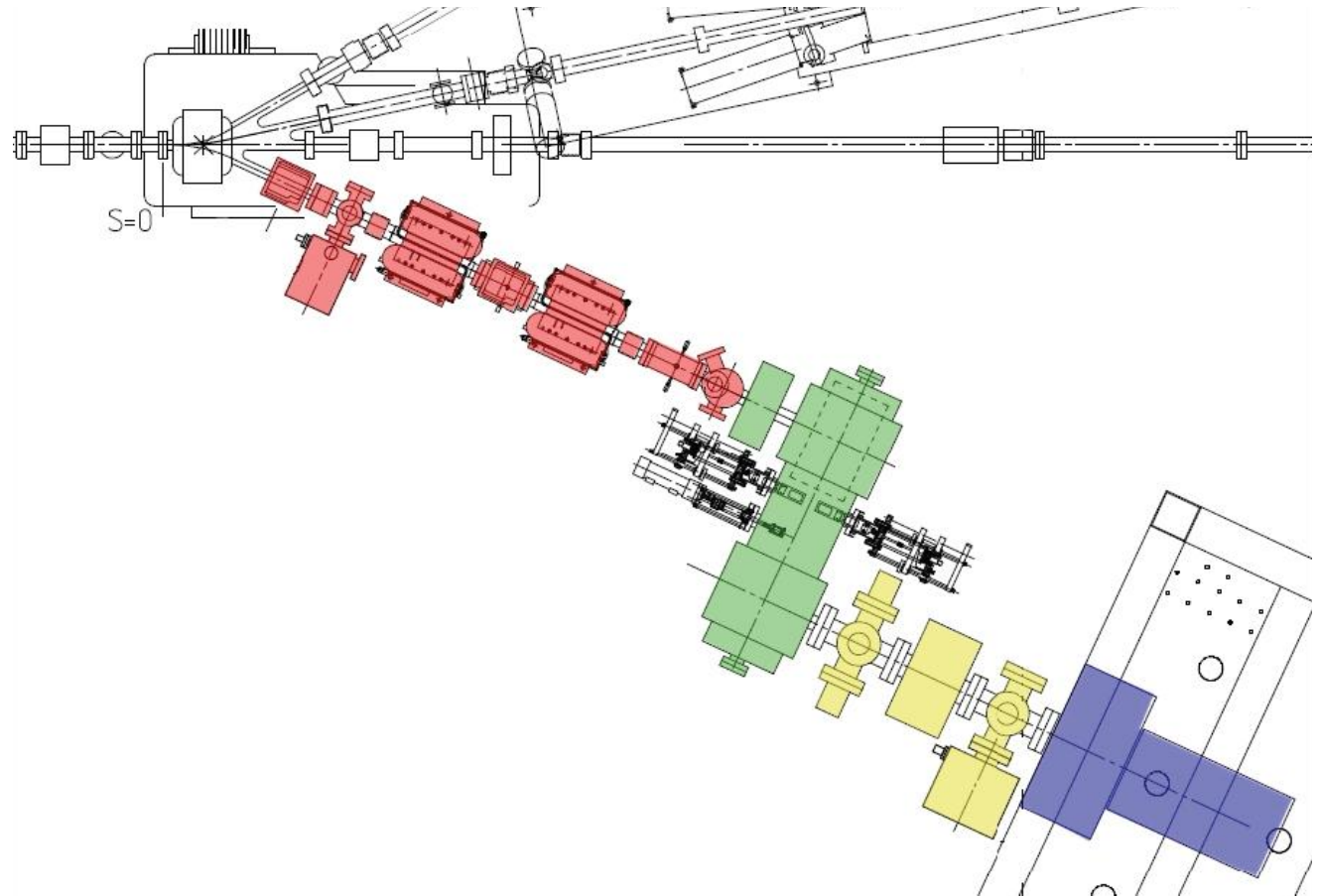

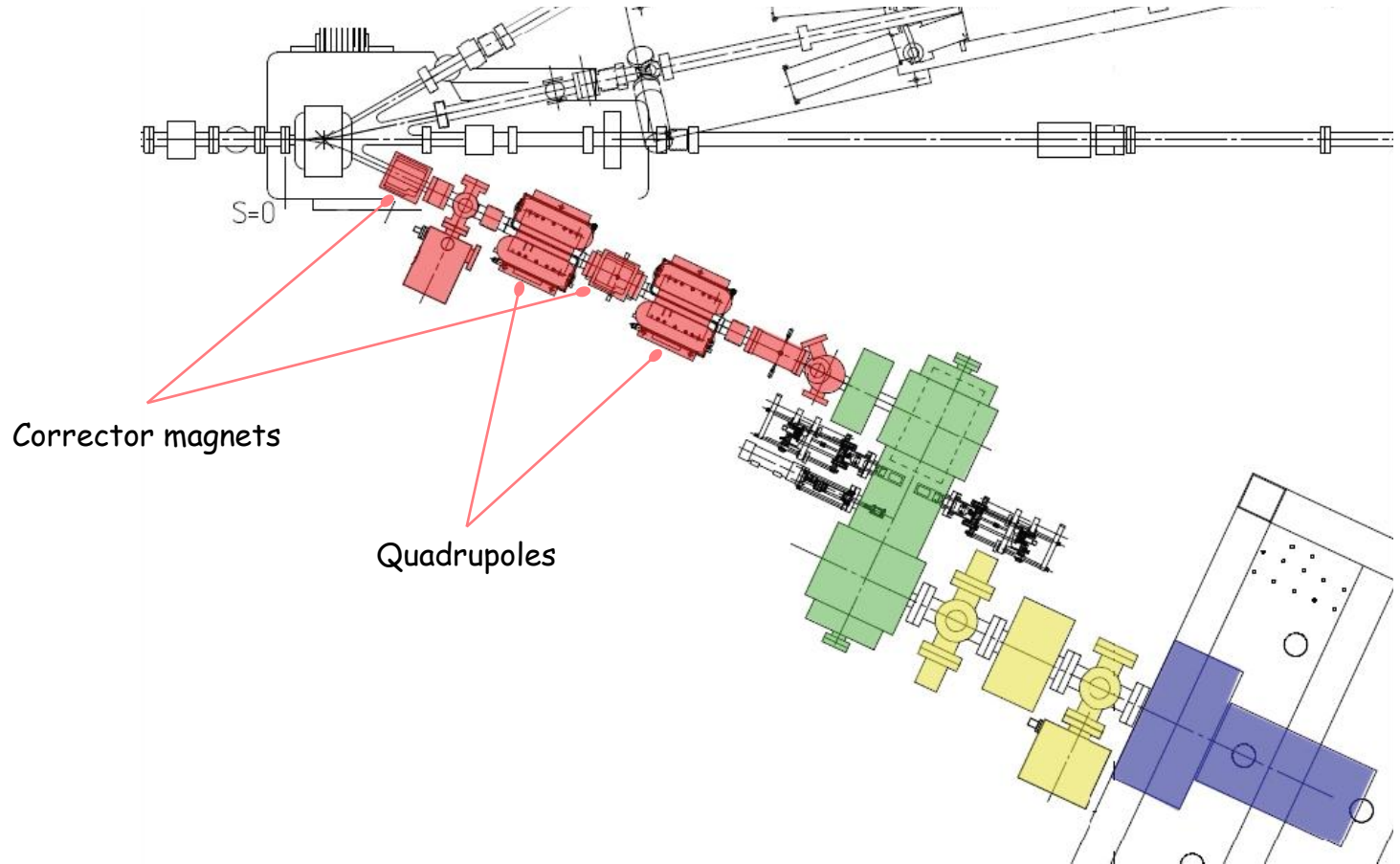

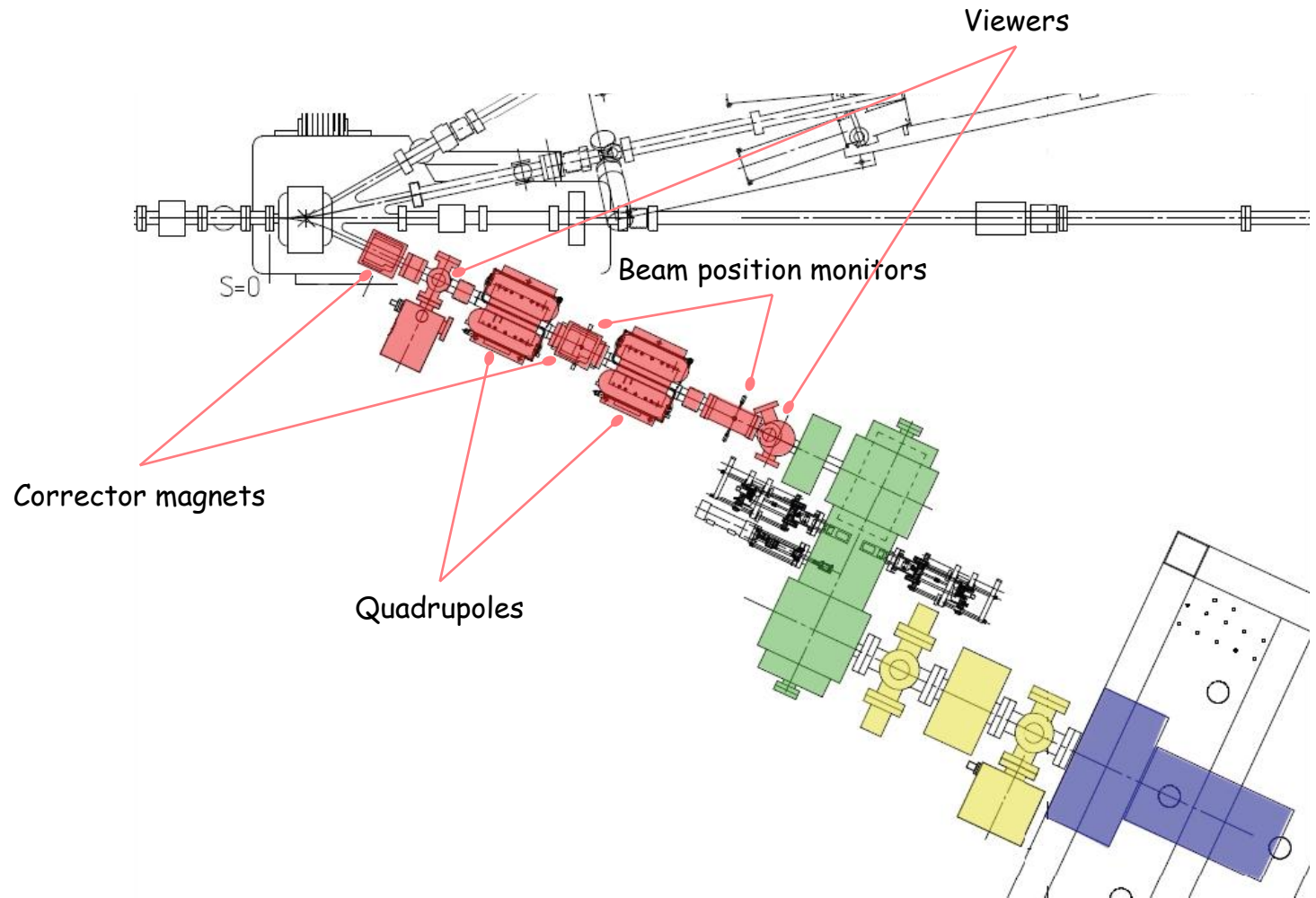

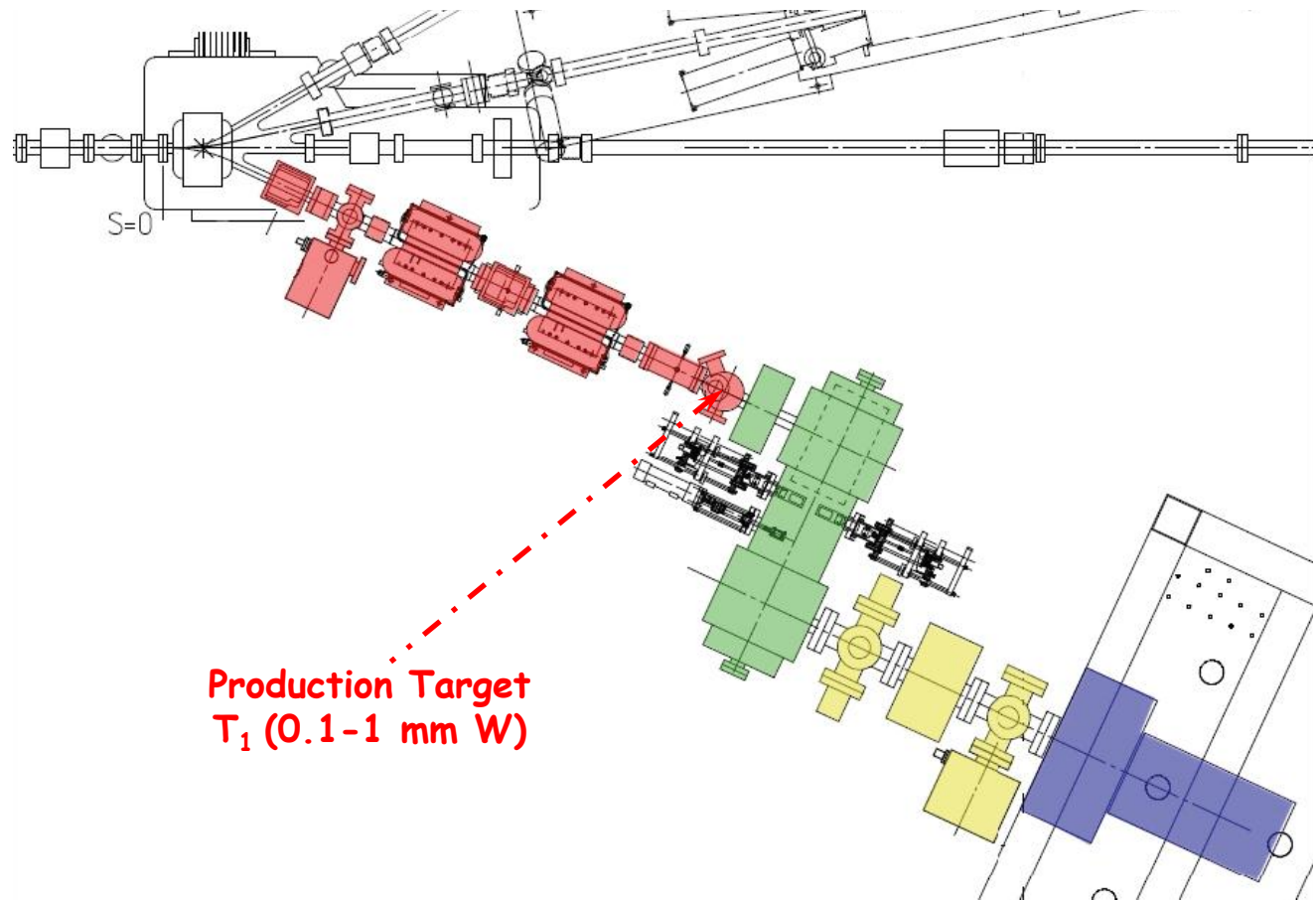



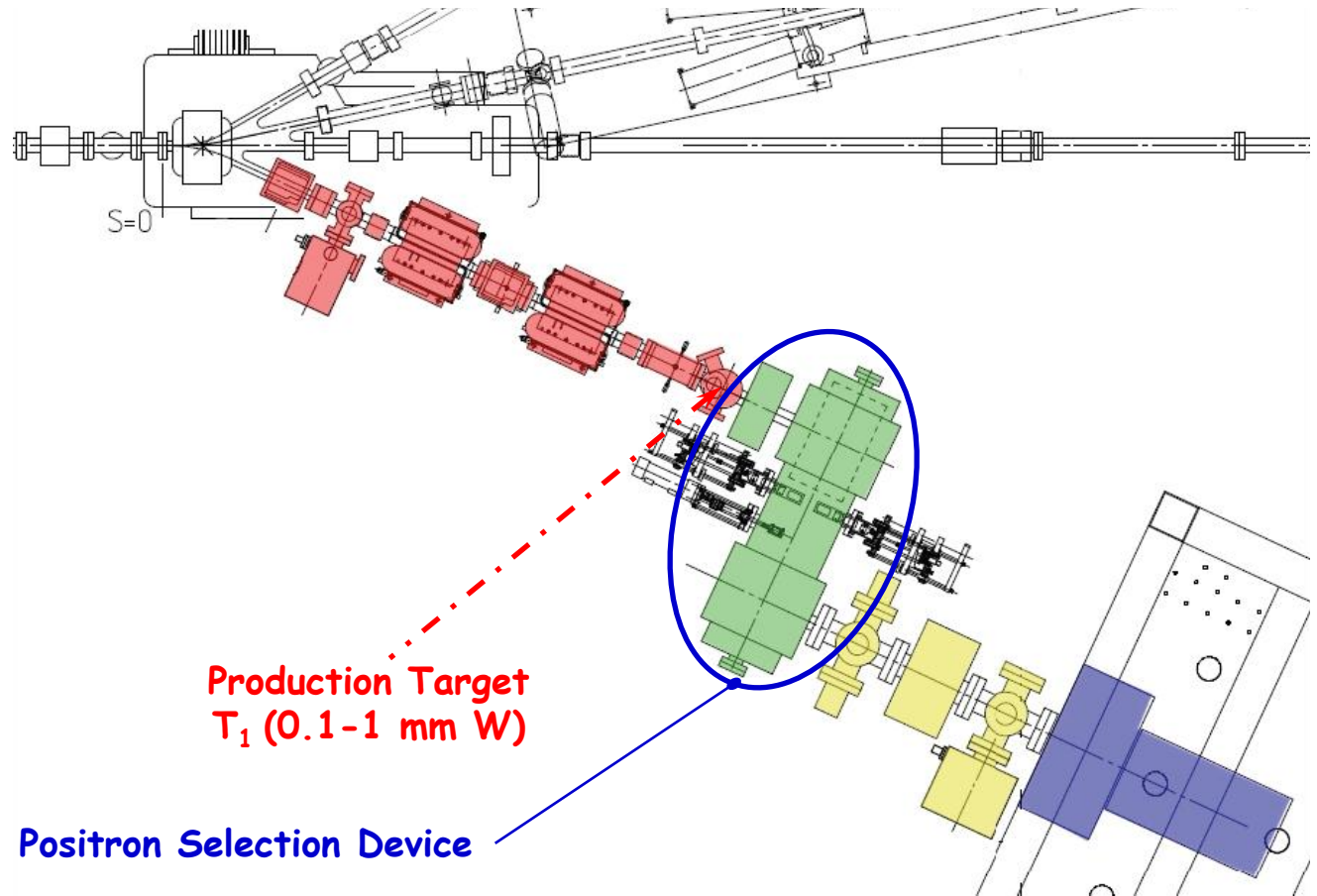

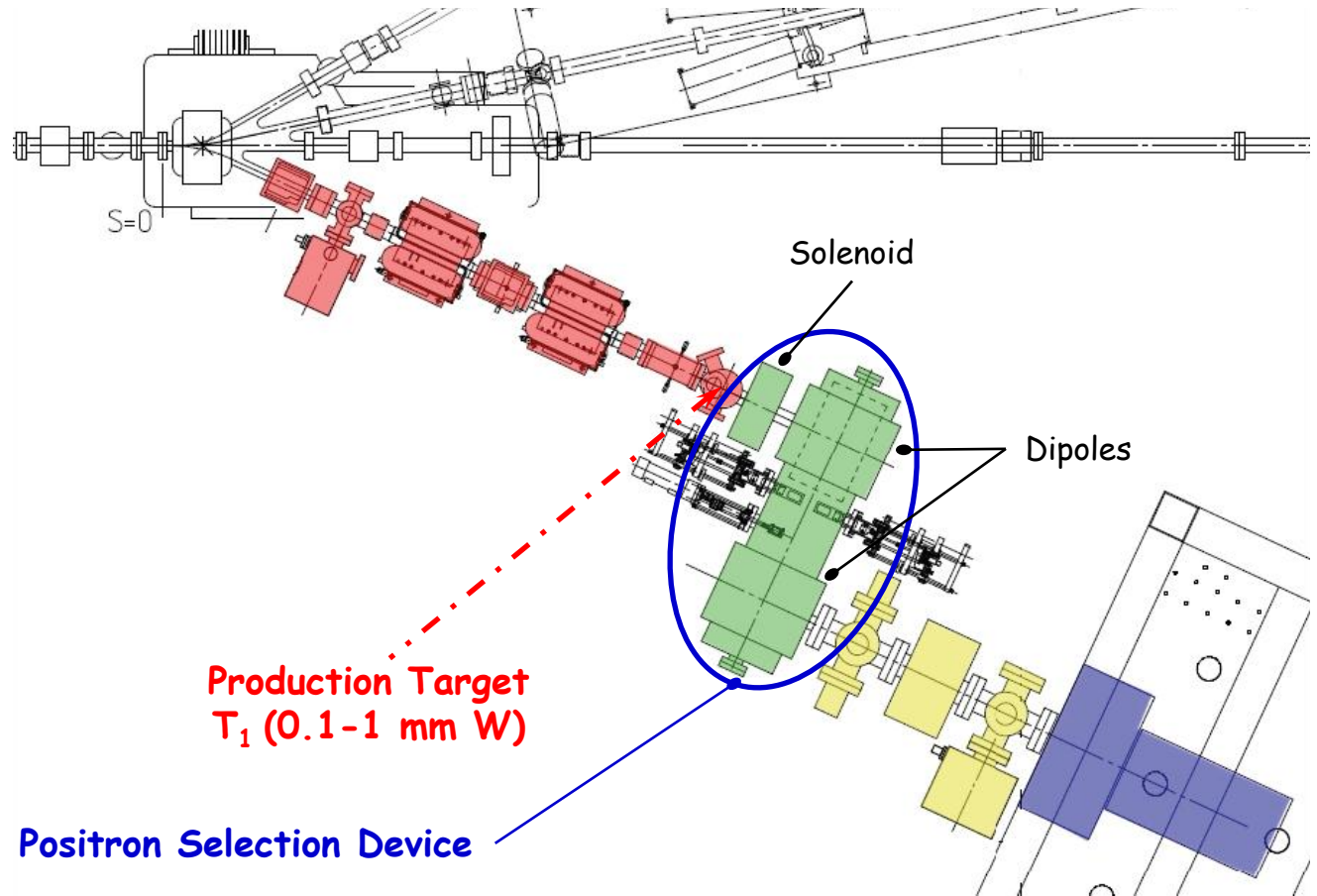

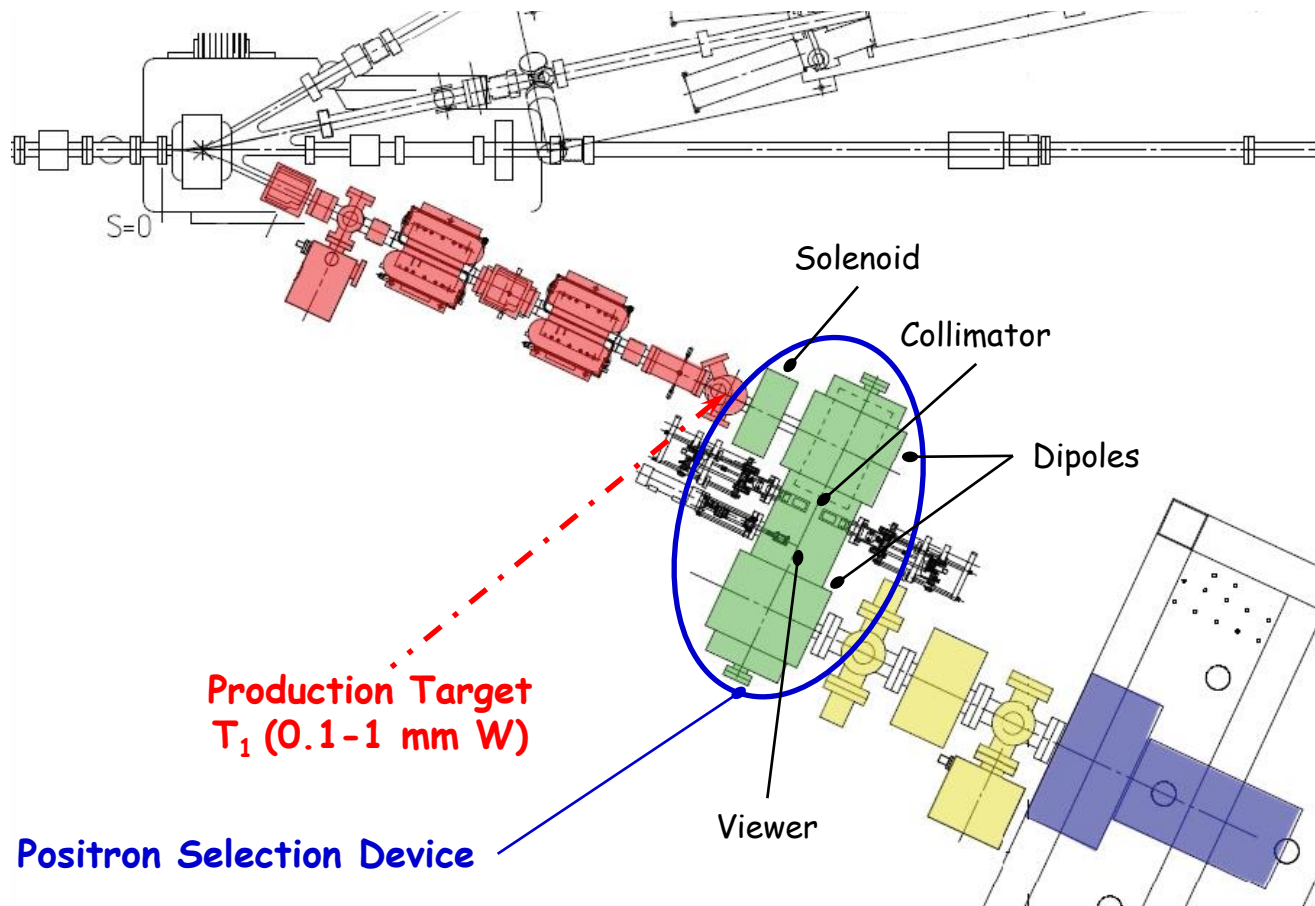

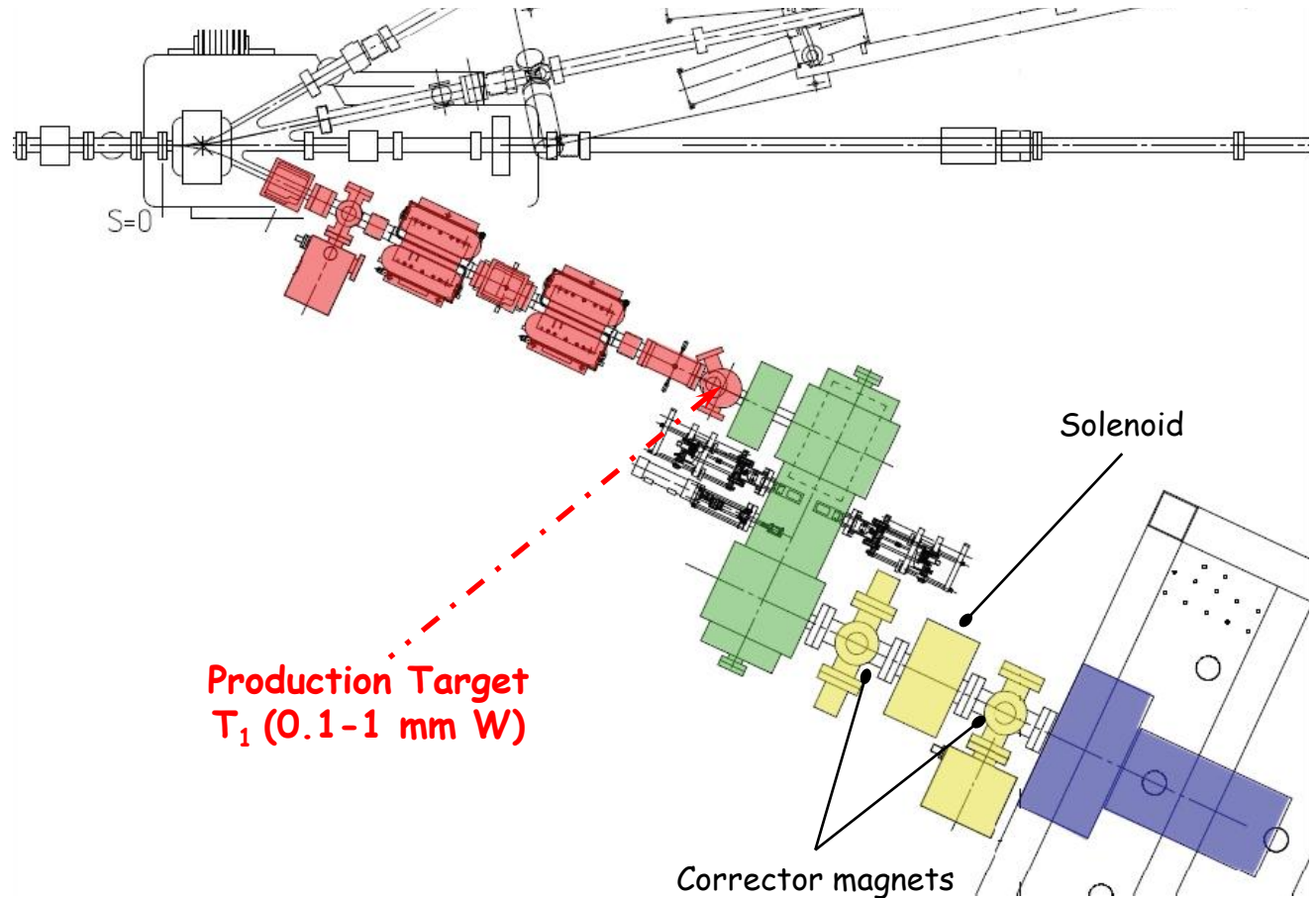

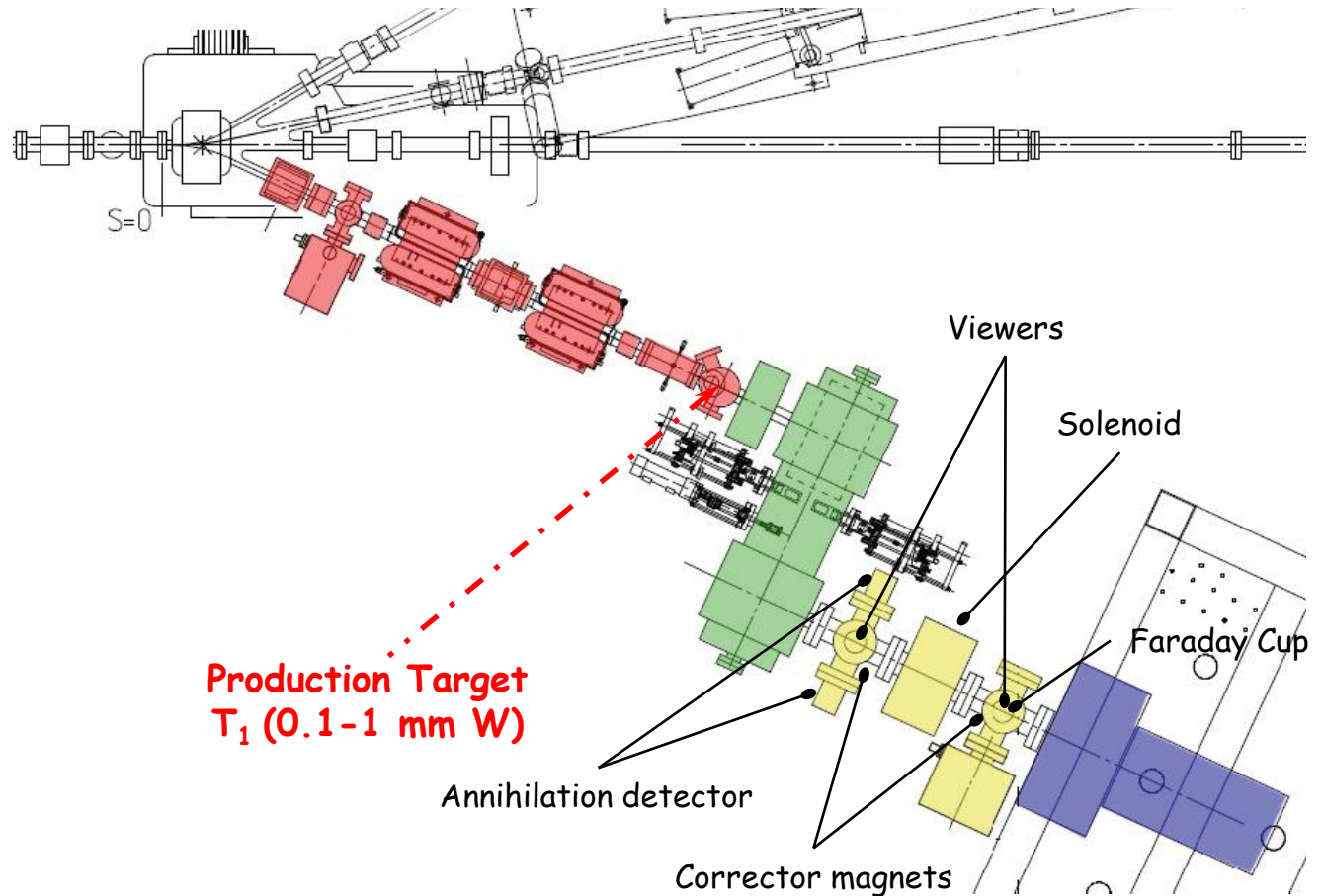

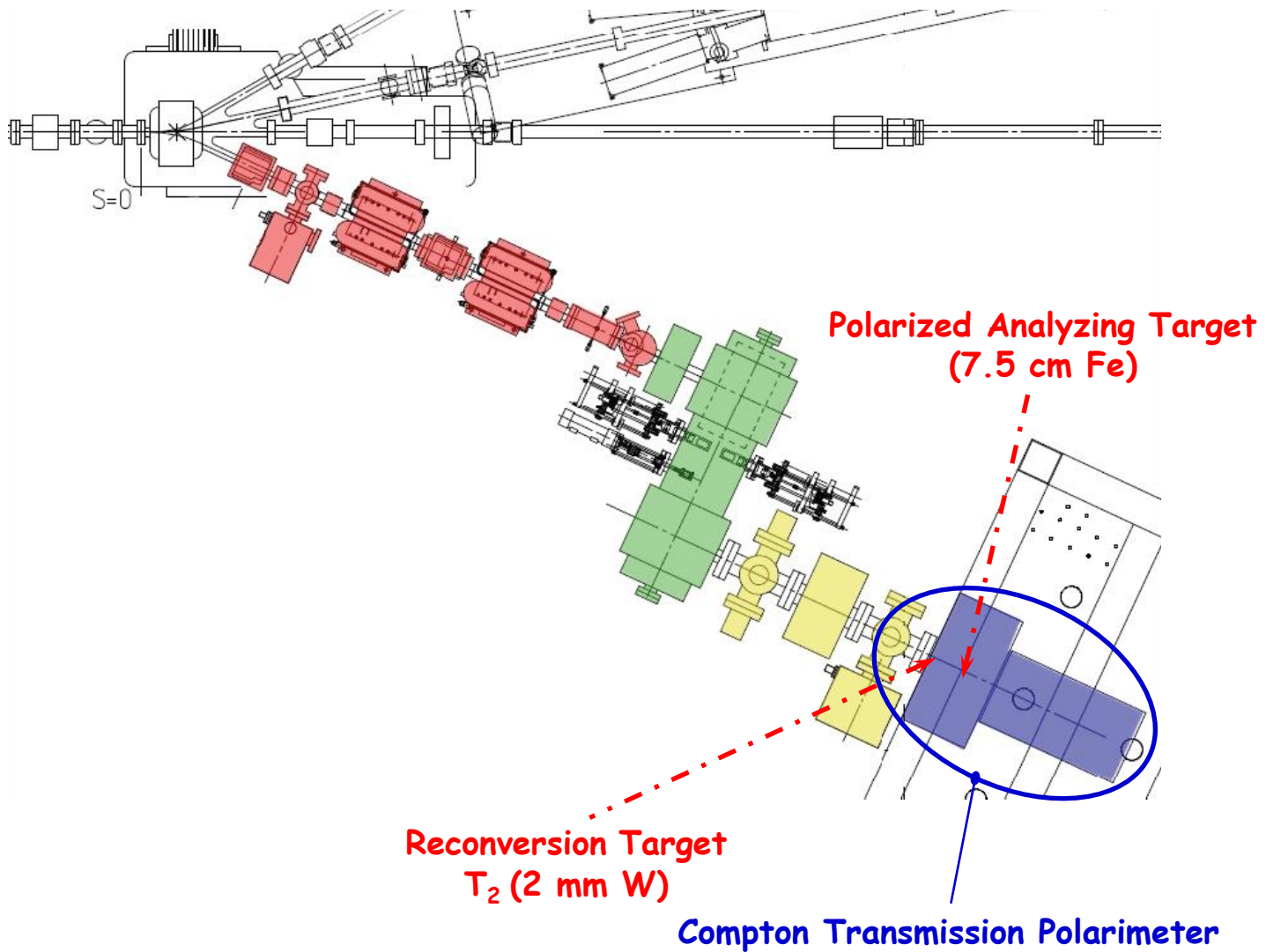

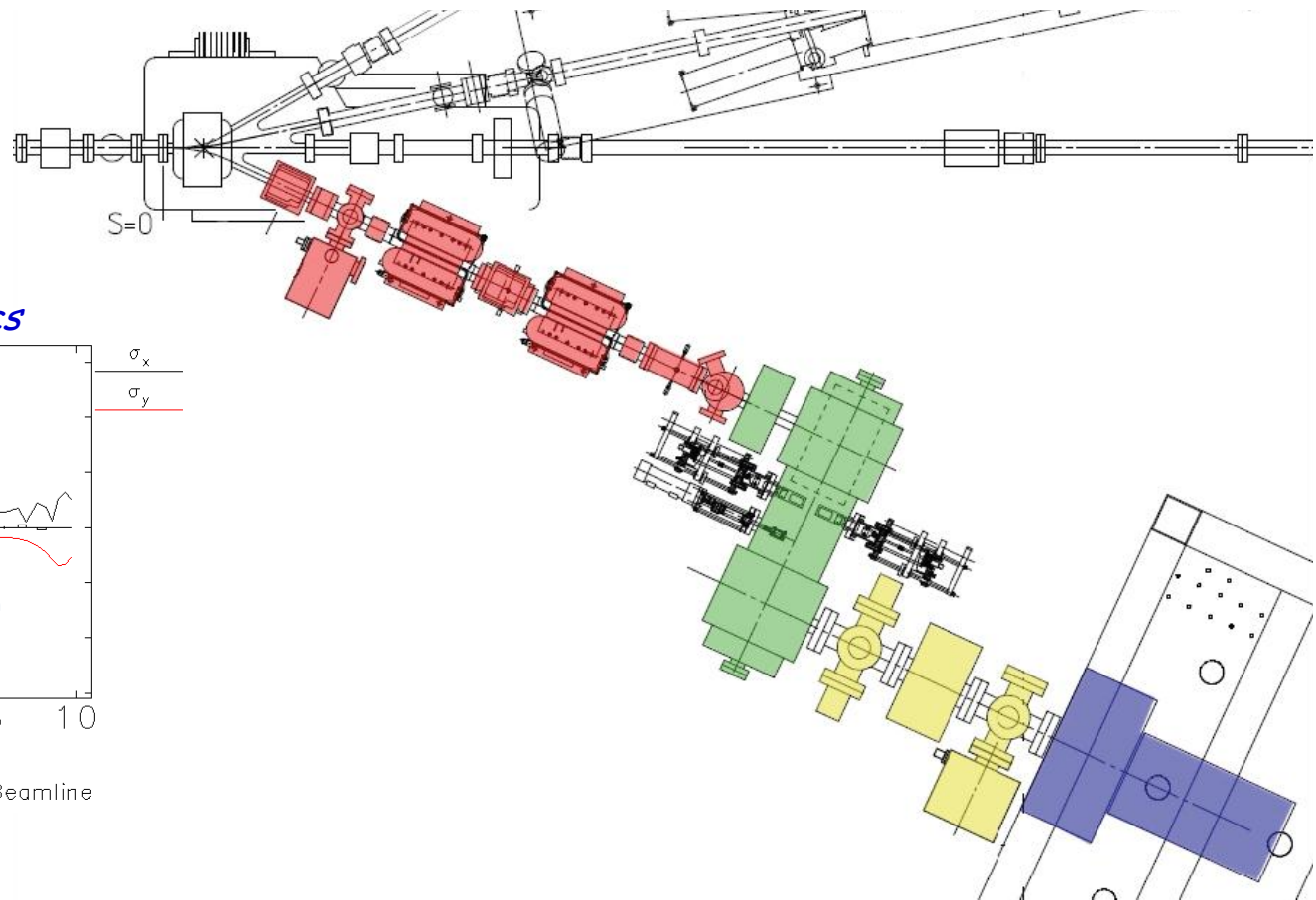

## ELEGANT beam optics

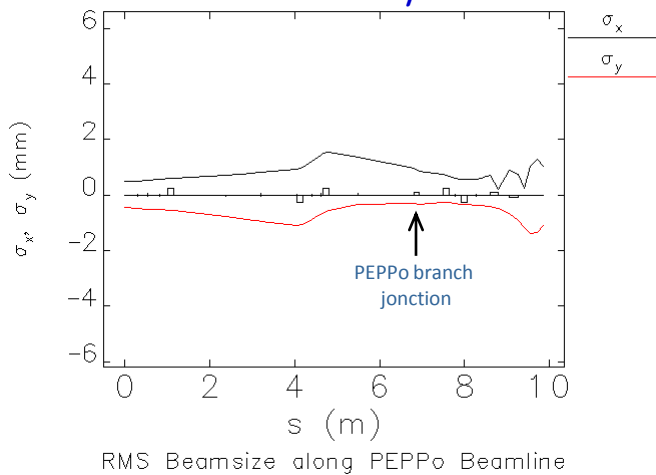

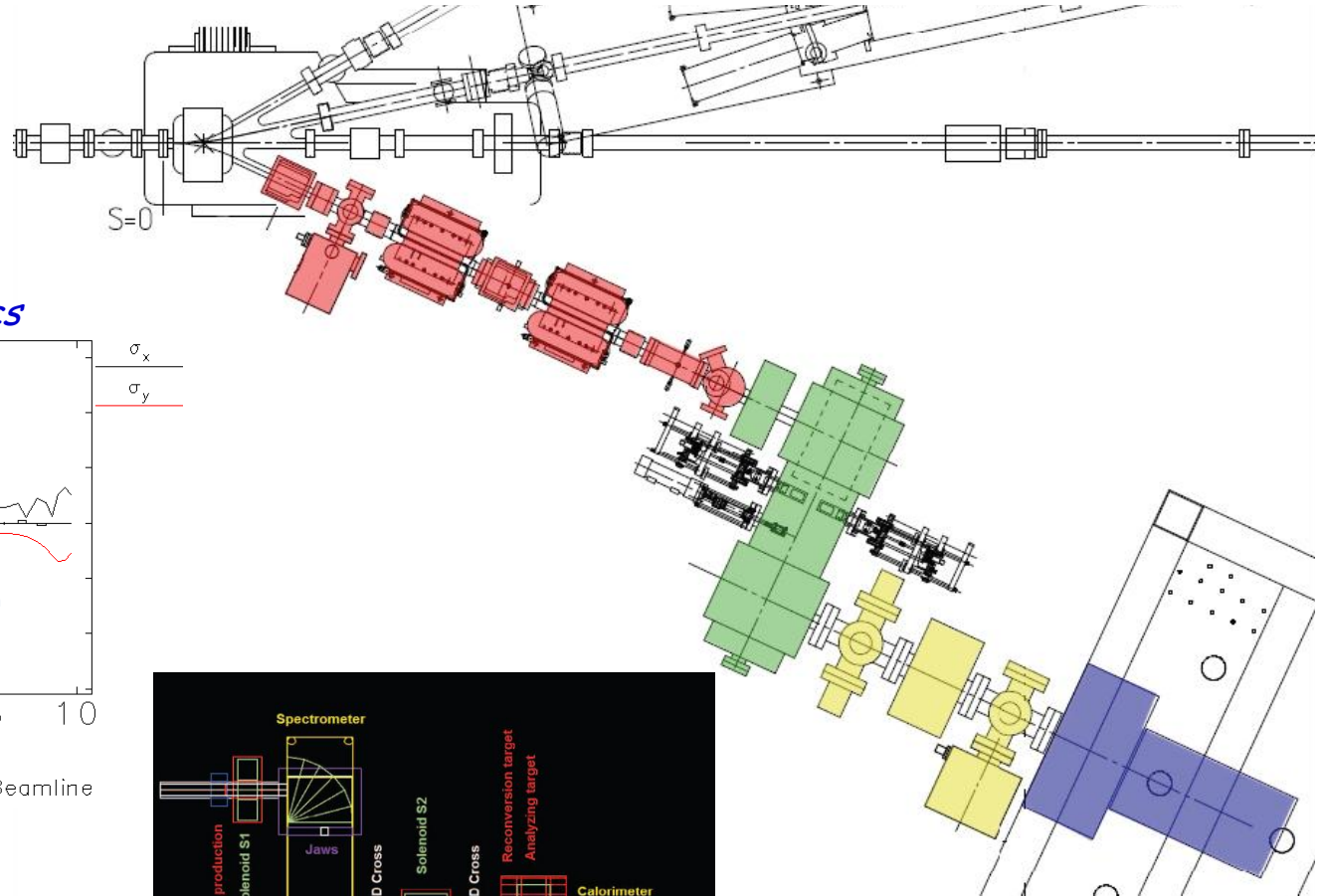

## ELEGANT beam optics

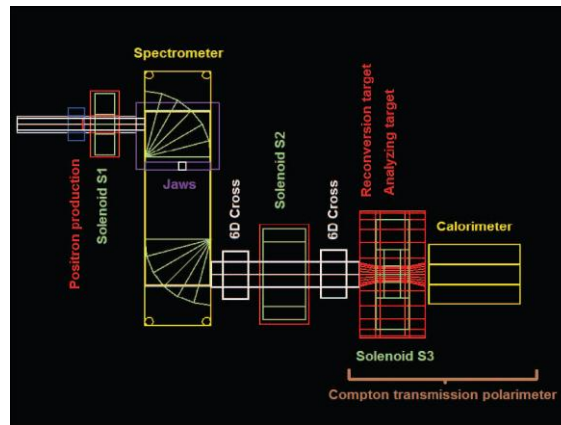
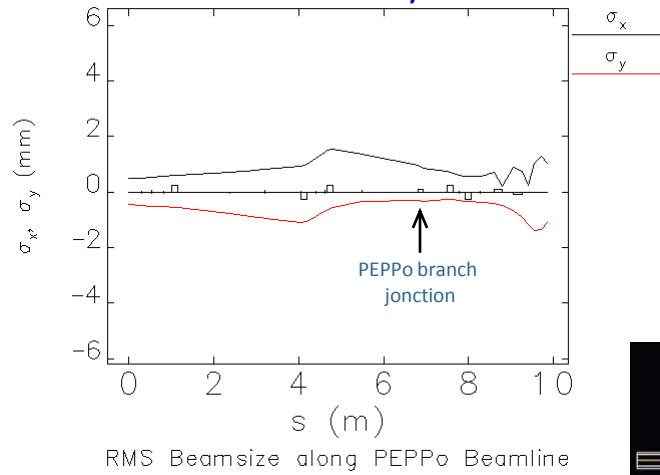



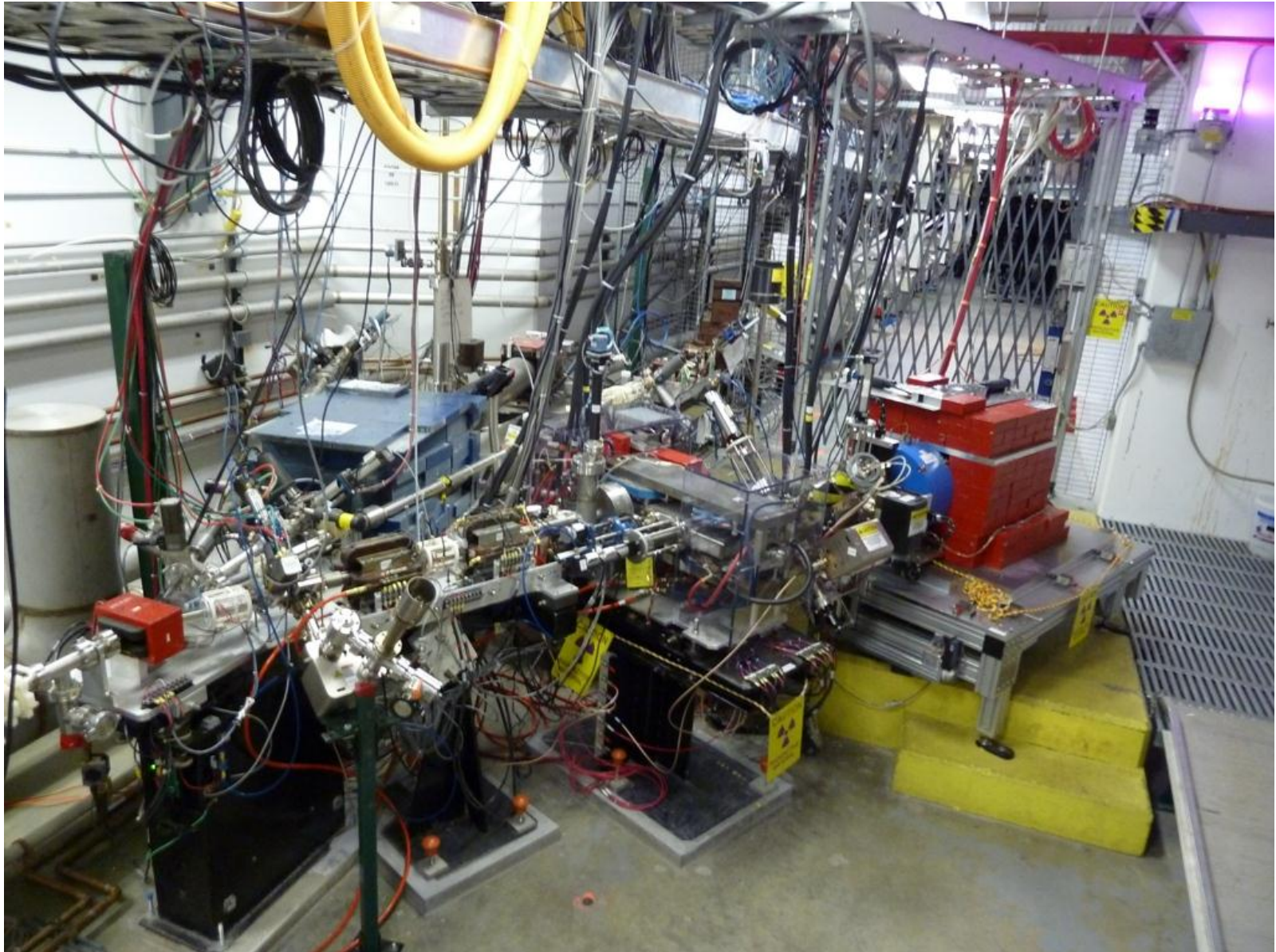

# Momentum Calibration

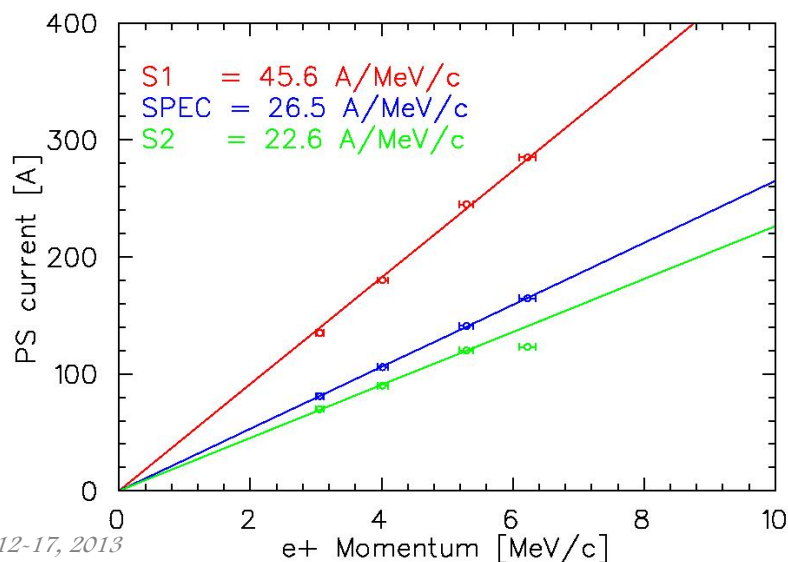
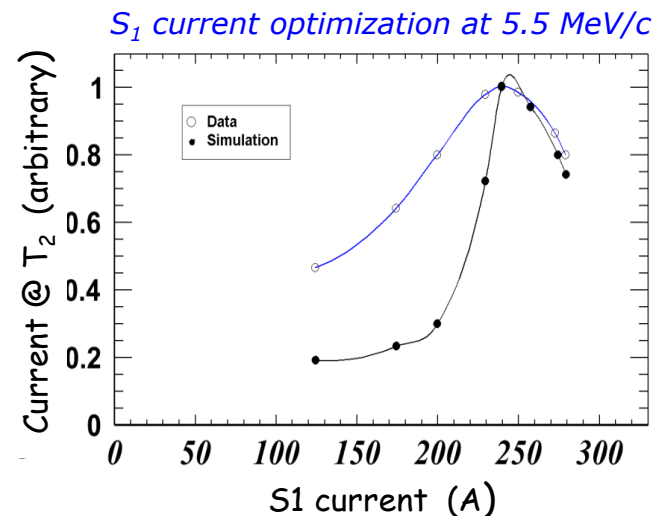
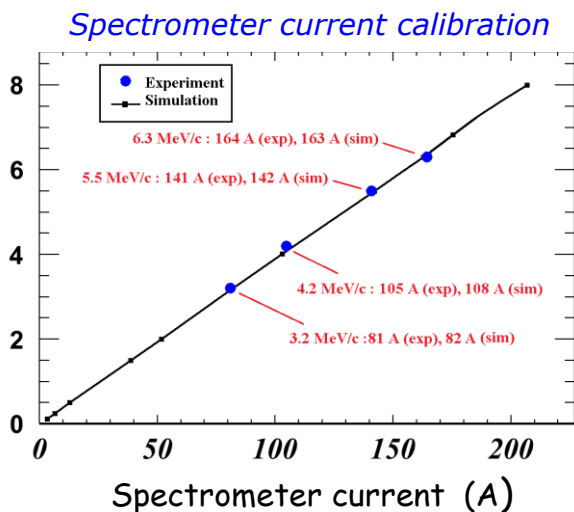
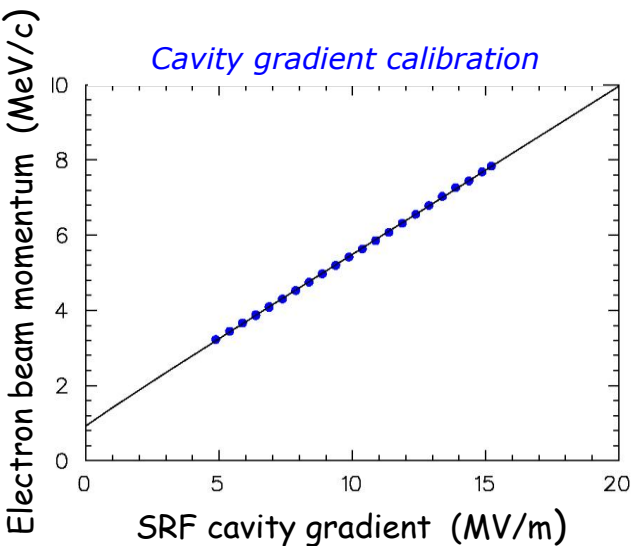

➤ The **spectrometer current**/momentum was calibrated with the **electron beam**.

➤ The **collection** and **transport solenoid currents** were **optimized** with **degraded electrons**, and **confirmed** with produced **positrons**.

# Positron Signal

- Two **NaI** detectors were used to measure the **back-to-back photons** emitted by the **annihilation of positrons** in an insertable target.

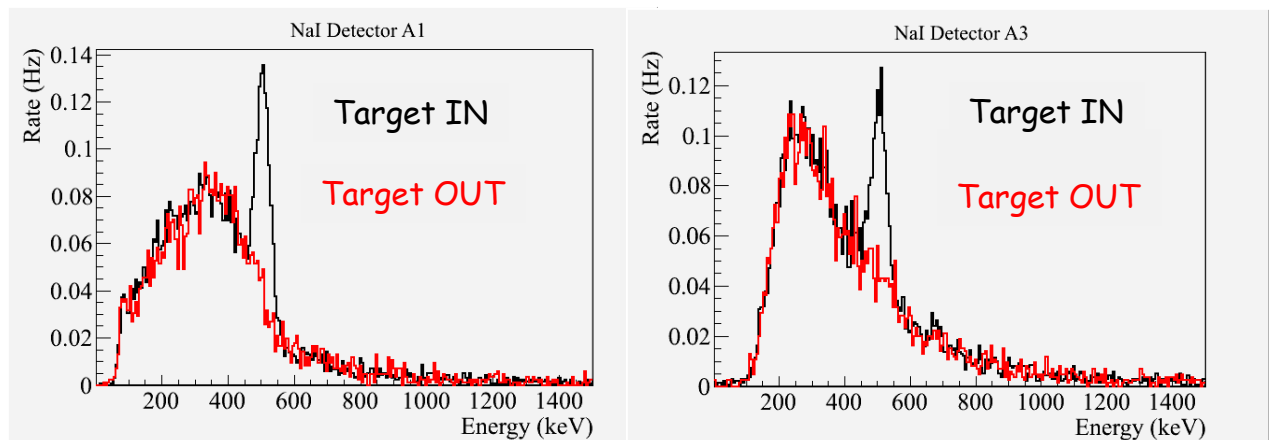
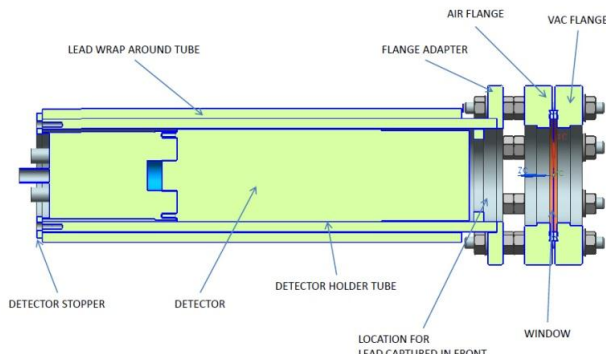
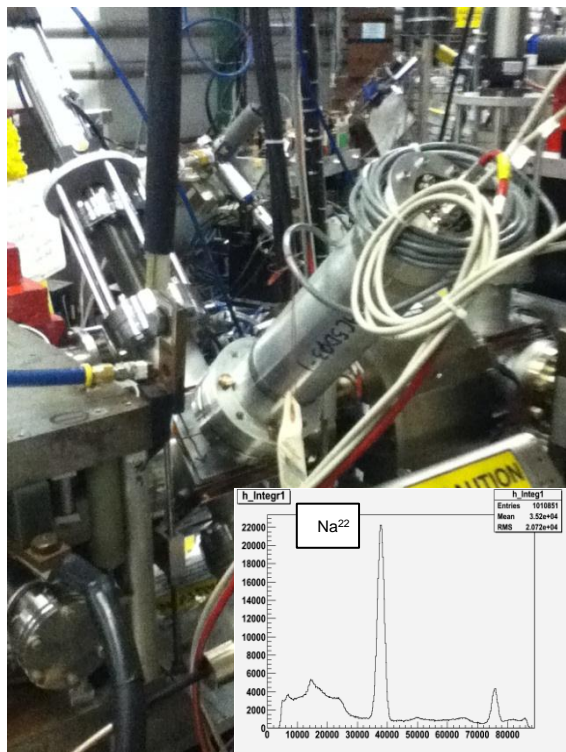

4 MeV/c  $e^+$  collected from 0.5 nA 7 MeV/c  $e^-$  on 1 mm W target

# DAQ Components

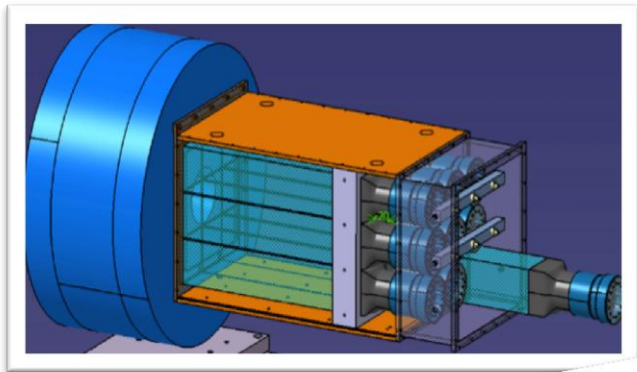

➤ **CsI crystals** are coupled to **PMTs** equipped with LPSC custom amplified basis to extend the **PMT life-time** in the high rate environment of PEPPo.

➤ The  $\sim 2 \mu s$  long and **2 V** optimized signal is fed into the JLab custom **FADC250** that sampled the signal at **250 MHz**.

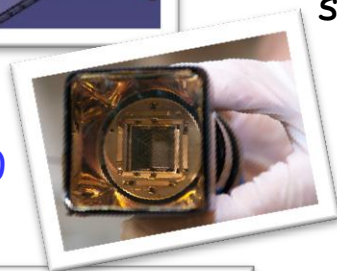

Hamamatsu R6236-100

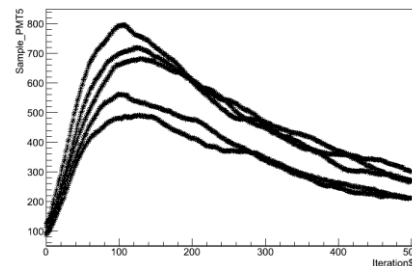

FADC 250

The flexibility of the **FADC250** allows for 3 data taking modes :

- **Sample** (**500 samples** /detector event);
- **Semi-integrated** (**1 integral** / detector event);
- **Integrated** (**1 integral** /helicity gate event).

# Integrated Mode Operation

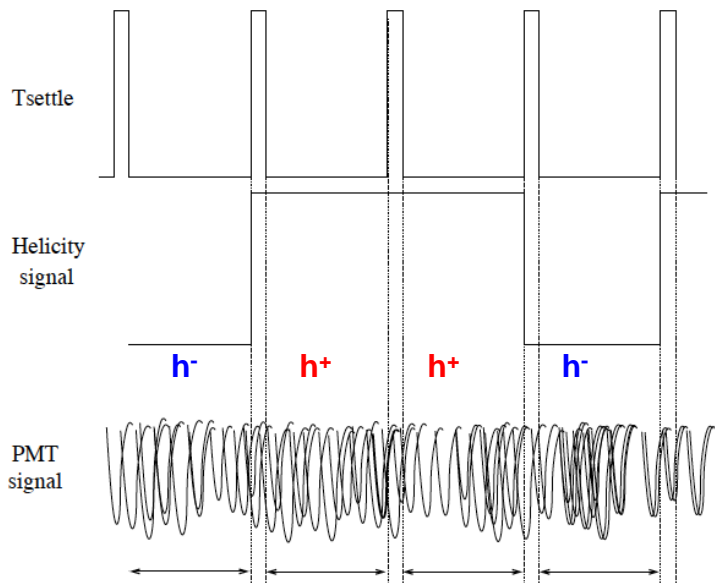

➤ The **integrated mode** operates for **high rate** conditions by **integration** of the **PMT signal** over the duration of an **helicity gate** (PEPPo firmware devoped by JLab).

Helicity frequency = 30 Hz

Helicity delay = 8 windows

Helicity pattern = quartet (+---+ or -++-)

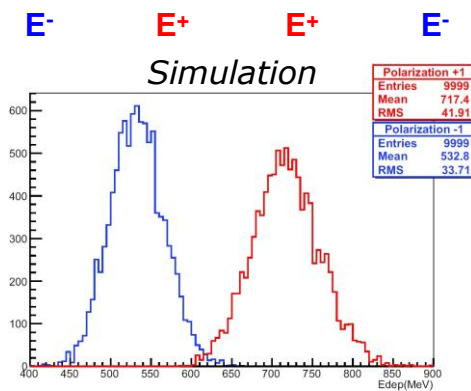

$$A_T = \frac{E^+ - E^-}{E^+ + E^-} = \frac{\dot{a}_i E_i^+ - \dot{a}_i E_i^-}{\dot{a}_i E_i^+ + \dot{a}_i E_i^-} = P_e \cdot P_T \cdot A_{e^-}$$

## Semi-Integrated Mode Operation

- The **PMT signals** are registered in the form of **one single value** corresponding to the **time-integrated signal over 2 μs**, and is **tagged by the helicity** status of the electron beam.

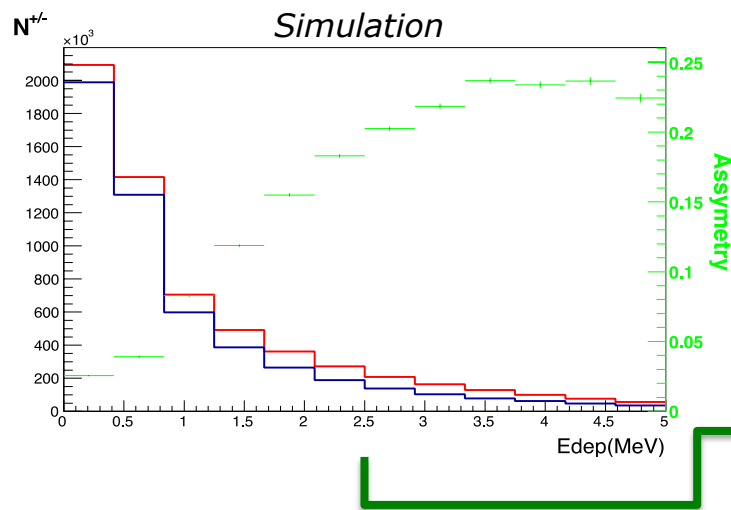

Helicity frequency = **30 Hz**  
 Helicity delay = **8 windows** and **none**  
 Helicity pattern = quartet (**+---** or **-+--**)

$$A_T^j = \frac{n_j^+ - n_j^-}{n_j^+ + n_j^-} = \frac{\int \dot{a}_i n_{ij}^+ - \dot{a}_i n_{ij}^-}{\int \dot{a}_i n_{ij}^+ + \dot{a}_i n_{ij}^-} = P_{e^+} P_T A_{e^+}^j$$

- Experimental **asymmetry** is determined for each **energy bin** and a corresponding **positron polarization** is determined knowing from **calibrated simulations** the **energy dependence** of the **positron analyzing power**.

## Data Taking

Data were taken using **two** major **sequences**:

- I. Use the polarized electron beam directly from the CEBAF injector to **calibrate** the **analyzing power** of the Compton transmission **polarimeter**;
- II. Use the Compton transmission polarimeter to **measure** the **polarization transfer** from electrons **to positrons**.

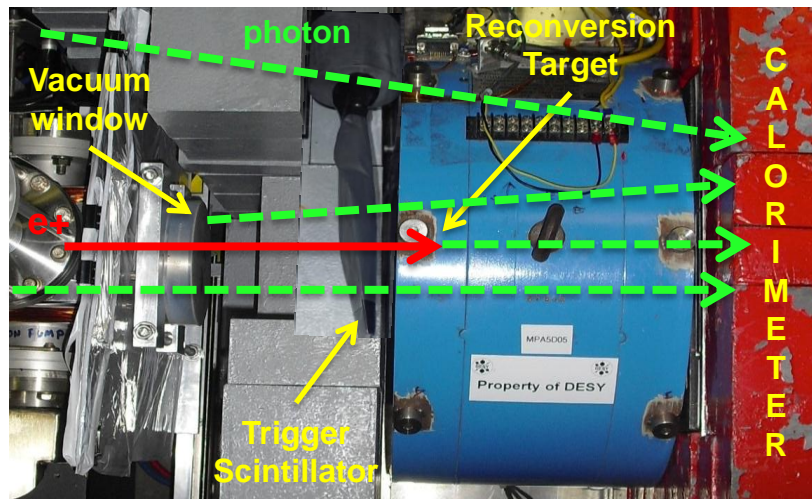

➤ The DAQ trigger for positron measurements is a **coincidence** between a **thin scintillator** placed prior the reconversion target, and the **central crystal (PMT5)**.

**Drastic reduction of the neutral background.**

## Data Taking - I

- Use **Mott polarimeter** to learn about the electron **beam polarization**.
- The **target polarization** is known from in-situ measurement of the **magnetic field** (O. Dadoun et al., MOPWA079).
- Measure **experimental asymmetry** with the **Compton transmission polarimeter**.

$P_{e^-}$ (MeV/c)	Mode	$I_{e^-}$ @ T2	Det. Rate (kHz)
3.2	Int.	60 pA	112
4.2	Int.	23 pA	184
5.5	Int.	25 pA	202
6.3	Int.	10 pA	471
7.3	Int.	10 pA	164

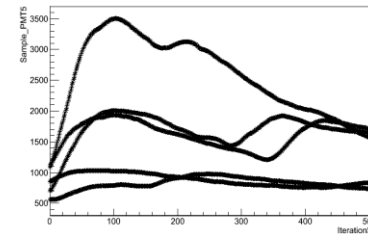

Pile up

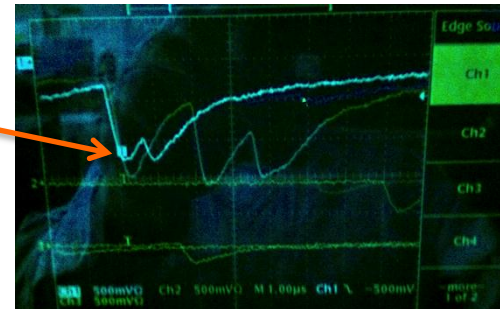

Combine results to determine the **analyzing power** for **electrons** and **benchmark** the **GEANT4 model** of the polarimeter.



# Preliminary Results

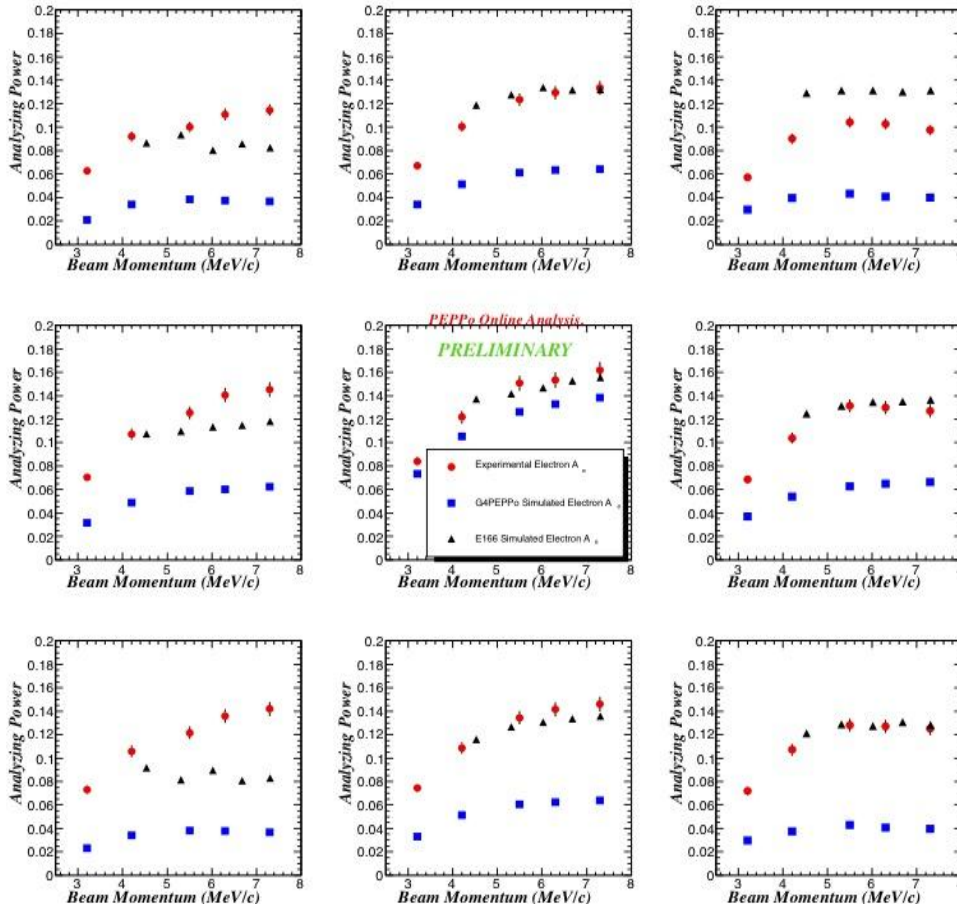

$$A_{e^-} = A_T / P_{e^-} P_T$$

- A high quality measurement of the **electron analyzing power** has been achieved and is currently in the **final analysis** stage.
- Experimental data are as expected selective with respect to simulations, allowing for the **calibration** of the **polarimeter model**.

# Preliminary Results

PEPPO On-line Analysis

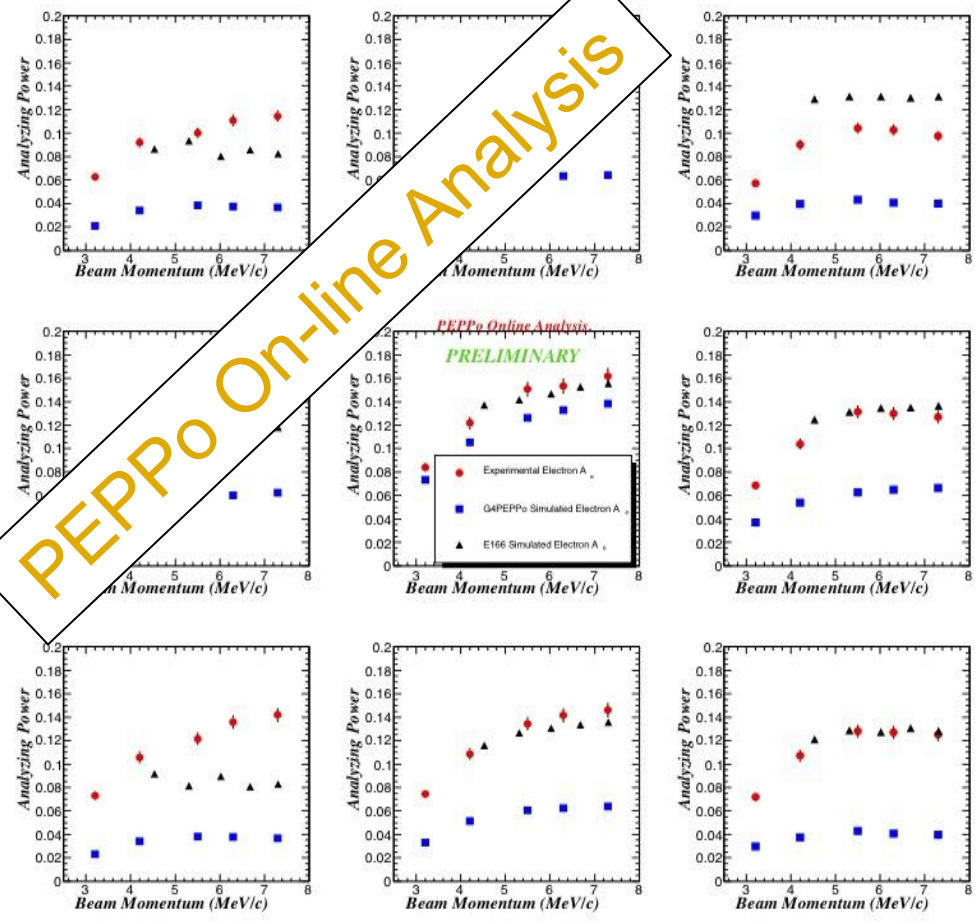

$$A_{e^-} = A_T / P_{e^-} P_T$$

- A high quality measurement of the **electron analyzing power** has been achieved and is currently in the **final analysis** stage.
- Experimental data are as expected selective with respect to simulations, allowing for the **calibration** of the **polarimeter model**.

## Data Taking - II

- Use **Mott polarimeter** to learn about the electron **beam polarization**.
- The **target polarization** is known from in-situ measurement of the **magnetic field**.
  - Use **electron calibration data** to determine the **positron analyzing power** (A. Adeyemi et al., MOPWA078).
- Measure **experimental asymmetry** with the **Compton transmission polarimeter**.

Mom (MeV/c)	Mode	Set	$I_{e^-}$ @ T1	Det.Rate (kHz)	Target (mm)
3.2	Sem.	1	380 nA	9	1
4.2	Sem.	1	25 nA	7	1
5.5	Sem.	1	95 nA	2	1
6.3	Sem.	1	380 nA	8	1
3.2	Sem.	2	120 nA	2	1
3.2	Sem.	2	380 nA	3	0.1
4.2	Sem.	2	130 nA	2	1
5.5	Sem.	2	200 nA	3	1
6.3	Sem.	2	620 nA	6	1

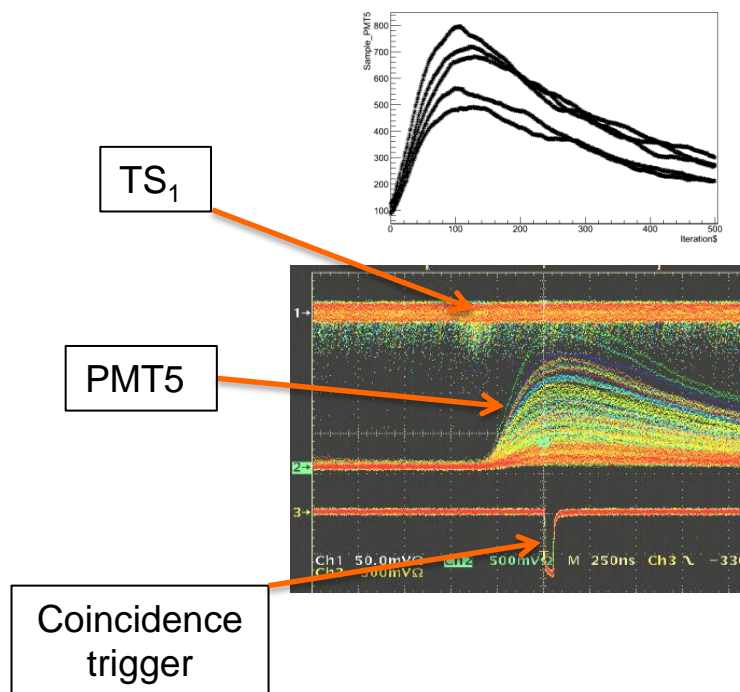

Measure polarization transfer from electrons to positrons.

## Energy Deposition Spectra

Adc 5

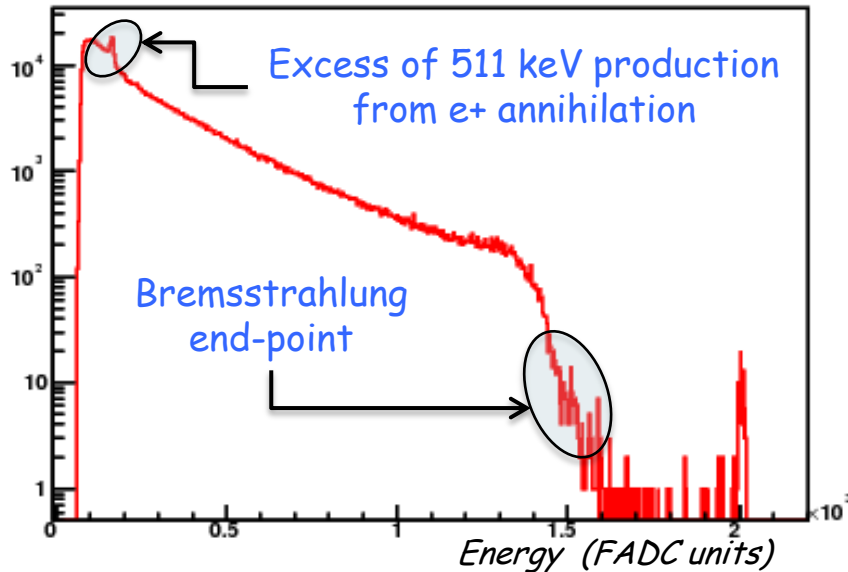

Tc: A5

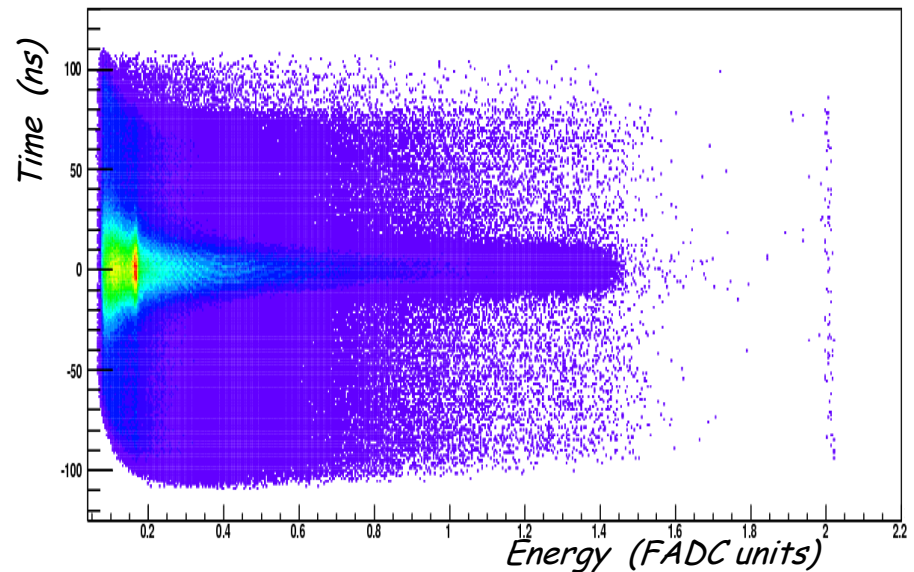
 $e^+$  Data @ 6.3 MeV/c

- The location of the **511 keV peak** is used for **in-situ monitoring** of the effective gain of the read-out chain to detect and correct for eventual **radiation damage** of the crystals or **PMT aging**.
- The **bremsstrahlung end-point** is used for additional **in-situ monitoring** of the effective **positron beam energy**.

# Preliminary Results

IHWP = IN, MPA5D05 = +60A	<span style="color: red;">●</span>
IHWP = IN, MPA5D05 = -60A	<span style="color: red;">○</span>
IHWP = OUT, MPA5D05 = +60A	<span style="color: blue;">●</span>
IHWP = OUT, MPA5D05 = -60A	<span style="color: blue;">○</span>

➤ Experimental asymetries in the range **2000-10000 ppm** are measured, pointing to an **efficient polarization transfer** from **Polarized Electrons** to **Polarized Positrons**.

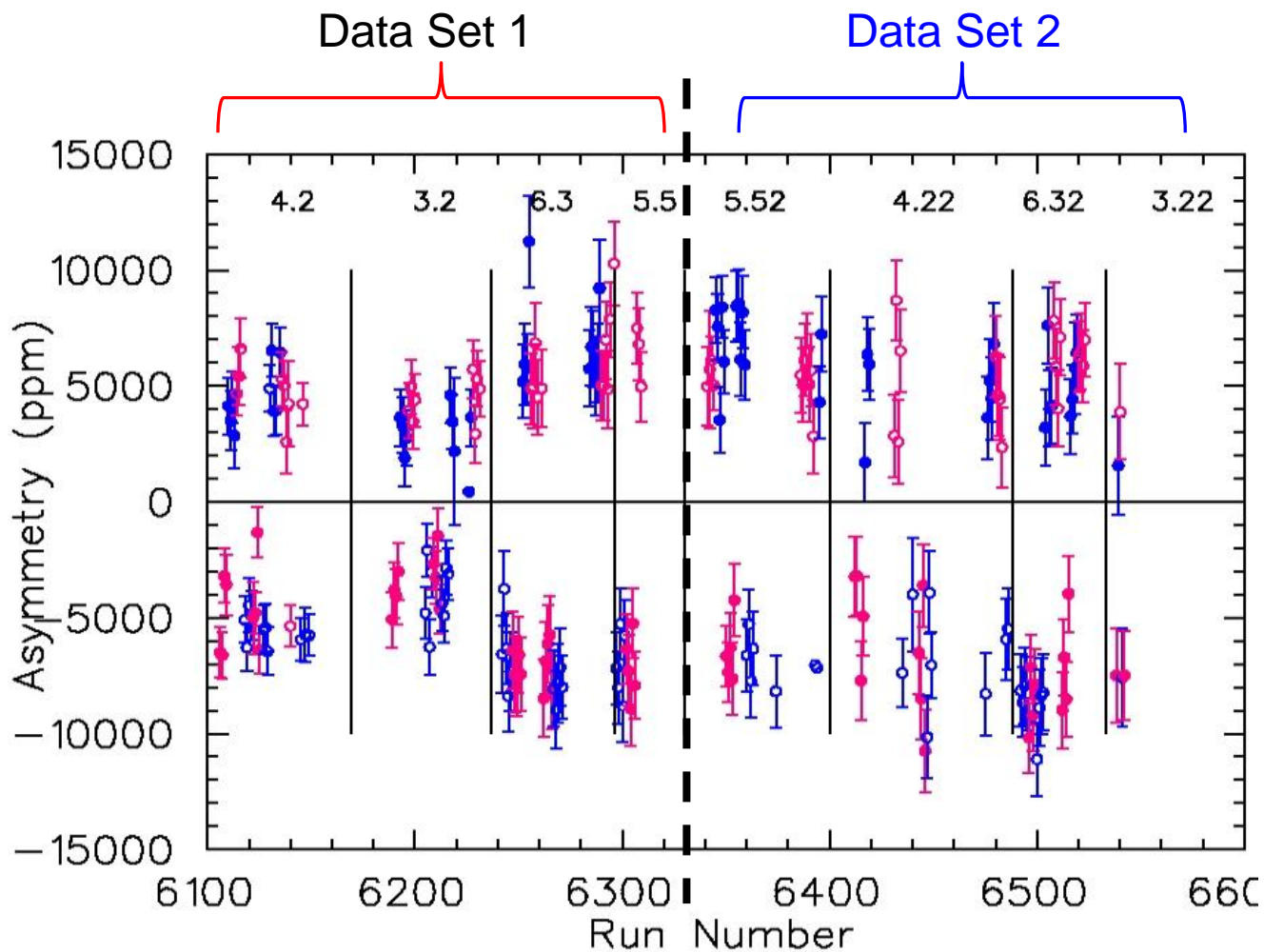

# Preliminary Results

IHWP = IN, MPA5D05 = +60A	●
IHWP = IN, MPA5D05 = -60A	○
IHWP = OUT, MPA5D05 = +60A	●
IHWP = OUT, MPA5D05 = -60A	○

➤ Experimental asymetries in the range **2000-10000 ppm** are measured, pointing to an **efficient polarization transfer** from **Polarized Electrons** to **Polarized Positrons**.

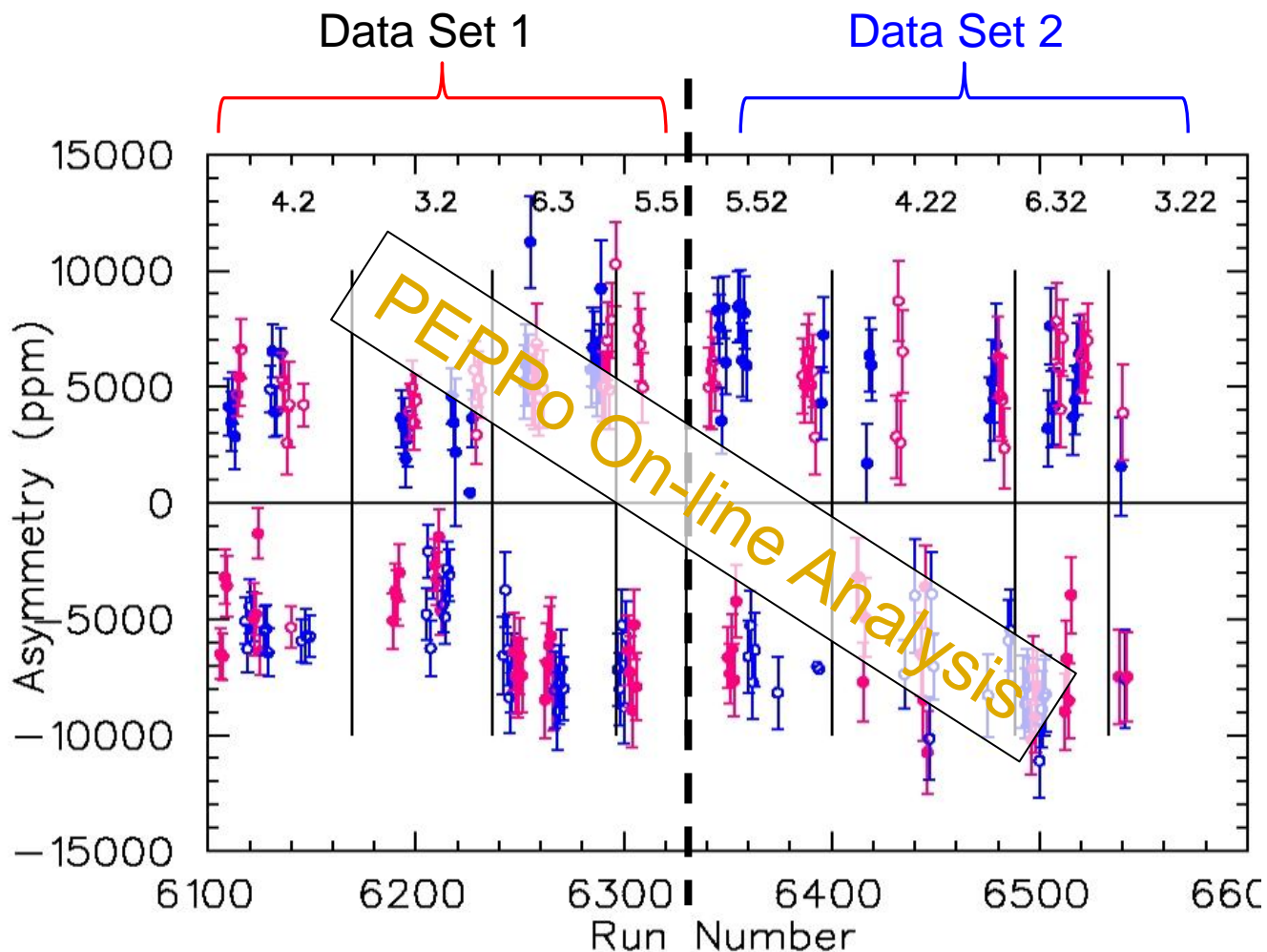

$$P_{e^+} = A_T / A_{e^+} P_T$$

PEPPO Data

Simulations

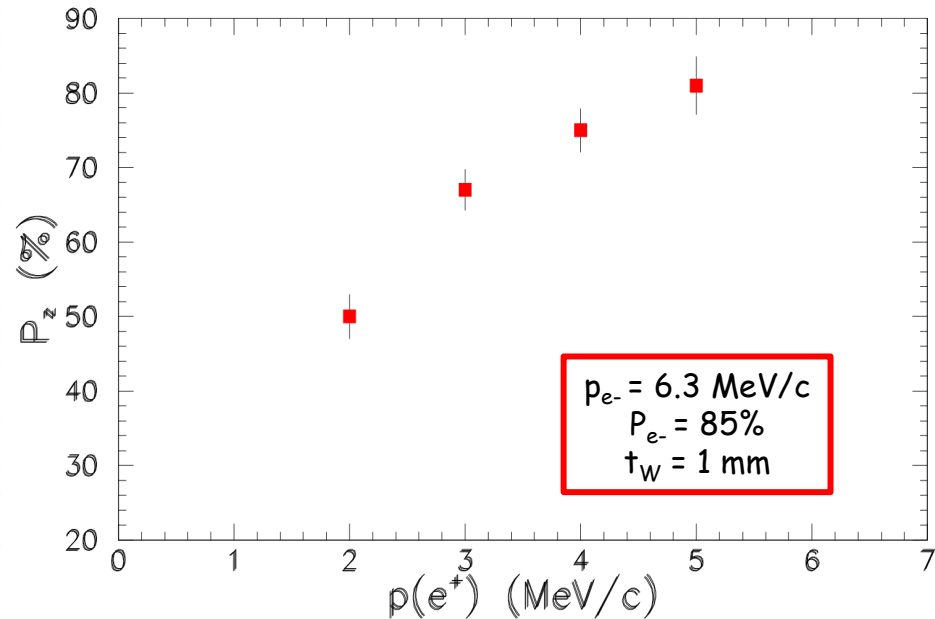
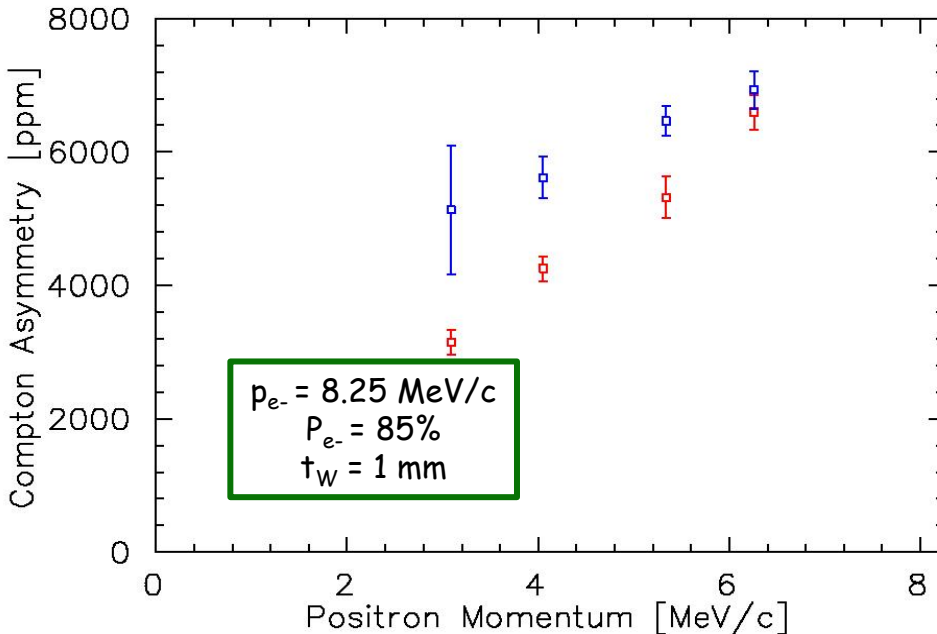

➤ PEPPO operated at **higher beam energy** as initially planned, improving yields and beam-time efficiency.

➤ The measured **energy dependence** of the **experimental asymmetry** is **consistent with expectations**.

$$P_{e^+} = A_T / A_{e^+} P_T$$

PEPPO Data

Simulations

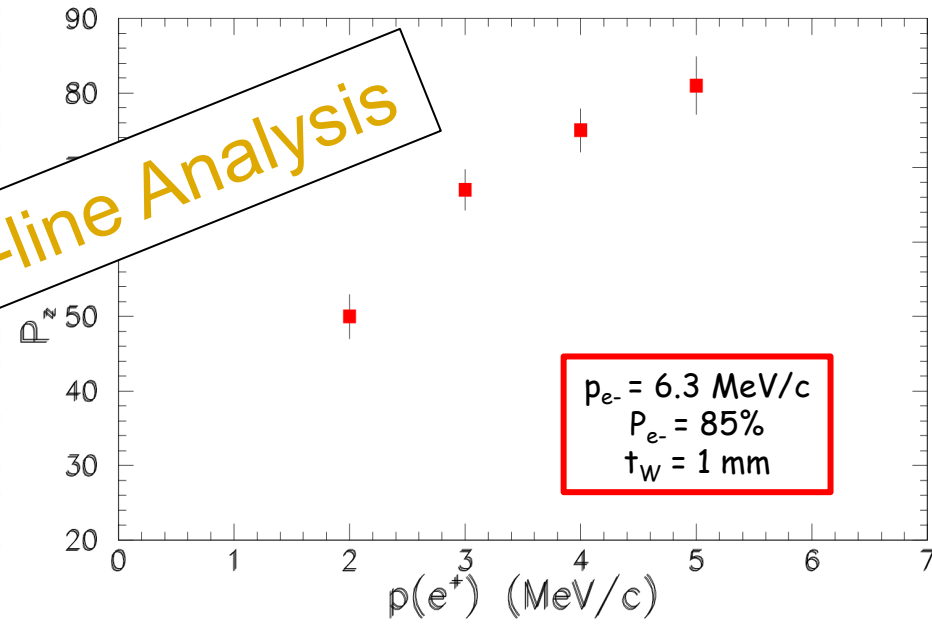
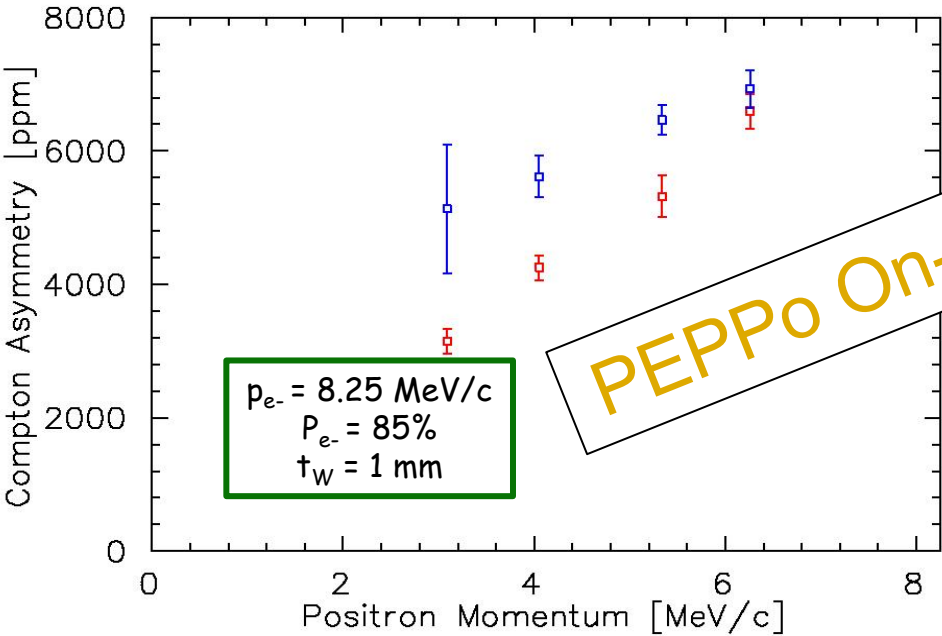

PEPPO On-line Analysis

- PEPPO operated at **higher beam energy** as initially planned, improving yields and beam-time efficiency.
- The measured **energy dependence** of the **experimental asymmetry** is **consistent with expectations**.



# PEPPO Collaboration

P. Aderley<sup>1</sup>, A. Adeyemi<sup>4</sup>, P. Aguilera<sup>1</sup>, M. Ali<sup>1</sup>, H. Areti<sup>1</sup>, M. Baylac<sup>2</sup>, J. Benesch<sup>1</sup>, G. Bosson<sup>2</sup>, B. Cade<sup>1</sup>, A. Camsonne<sup>1</sup>, L. Cardman<sup>1</sup>, J. Clark<sup>1</sup>, P. Cole<sup>5</sup>, S. Covert<sup>1</sup>, C. Cuevas<sup>1</sup>, O. Dadoun<sup>3</sup>, D. Dale<sup>5</sup>, J. Dumas<sup>1,2</sup>, E. Fanchini<sup>2</sup>, T. Forest<sup>5</sup>, E. Forman<sup>1</sup>, A. Freyberger<sup>1</sup>, E. Froidefond<sup>2</sup>, S. Golge<sup>6</sup>, J. Grames<sup>1</sup>, P. Guèye<sup>4</sup>, J. Hansknecht<sup>1</sup>, P. Harrell<sup>1</sup>, J. Hoskins<sup>8</sup>, C. Hyde<sup>7</sup>, R. Kazimi<sup>1</sup>, Y. Kim<sup>1,5</sup>, D. Machie<sup>1</sup>, K. Mahoney<sup>1</sup>, R. Mammei<sup>1</sup>, M. Marton<sup>2</sup>, J. McCarter<sup>9</sup>, M. McCaughan<sup>1</sup>, M. McHugh<sup>10</sup>, D. McNulty<sup>5</sup>, T. Michaelides<sup>1</sup>, R. Michaels<sup>1</sup>, C. Muñoz Camacho<sup>11</sup>, J.-F. Muraz<sup>2</sup>, K. Myers<sup>12</sup>, A. Opper<sup>10</sup>, M. Poelker<sup>1</sup>, J.-S. Réal<sup>2</sup>, L. Richardson<sup>1</sup>, S. Setiniyazi<sup>5</sup>, M. Stutzman<sup>1</sup>, R. Suleiman<sup>1</sup>, C. Tennant<sup>1</sup>, C.-Y. Tsai<sup>13</sup>, D. Turner<sup>1</sup>, A. Variola<sup>3</sup>, E. Voutier<sup>2</sup>, Y. Wang<sup>1</sup>, Y. Zhang<sup>12</sup>

<sup>1</sup> Jefferson Lab, Newport News, VA, US    <sup>2</sup> LPSC, Grenoble, France    <sup>3</sup> LAL, Orsay, France

<sup>4</sup> Hampton University, Hampton, VA, USA    <sup>5</sup> Idaho State University & IAC, Pocatello, ID, USA

<sup>6</sup> North Carolina University, Durham, NC, USA    <sup>7</sup> Old Dominion University, Norfolk, VA, US

<sup>8</sup> The College of William & Mary, Williamsburg, VA, USA    <sup>9</sup> University of Virginia, Charlottesville, VA, USA

<sup>10</sup> George Washington University, Washington, DC, USA    <sup>11</sup> IPN, Orsay, France

<sup>12</sup> Rutgers University, Piscataway, NJ, USA    <sup>13</sup> Virginia Tech, Blacksburg, VA, USA

Many thanks for advice, equipment loan, GEANT4 modeling support, and funding to

**SLAC E-166 Collaboration**  
**International Linear Collider Project**  
**Jefferson Science Association Initiatives Award**



## Storage Ring Scheme

- Polarized positrons have been obtained in high energy storage ring taking advantage of the **Sokolov-Ternov** effect which leads to **positrons polarized parallel to the magnetic field**.

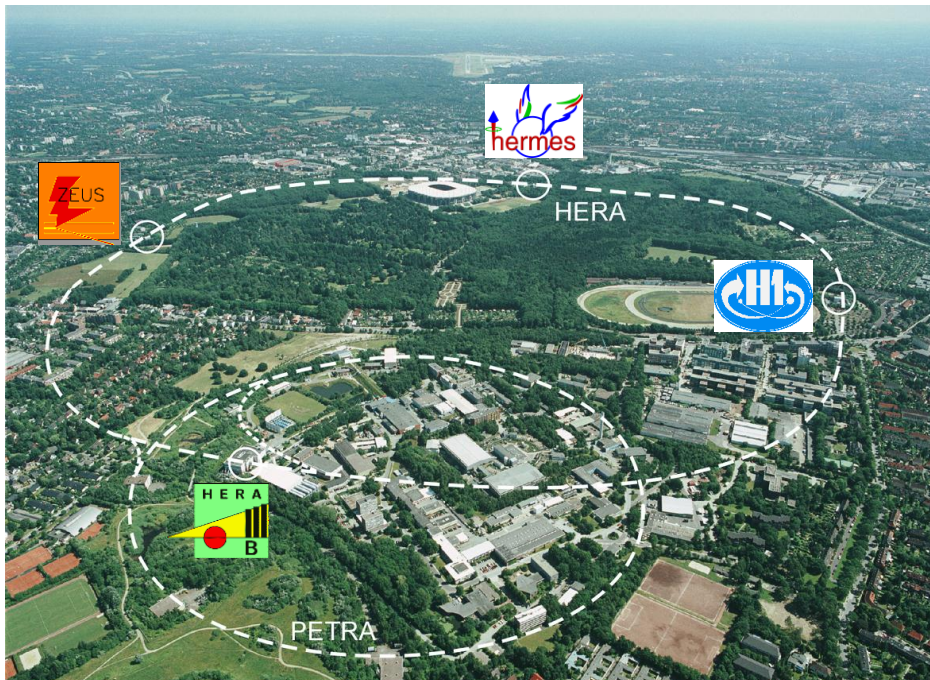

Polarization builds up exponentially with a time constant characteristic of the energy and the curvature of the positrons

$$\tau = \frac{8}{5\sqrt{3}} \frac{m_e^2 c^2}{\hbar e^2} \frac{\rho^3}{\gamma^5}$$

$$\tau \sim 20 \text{ mn @ HERA}$$

## Storage Ring Scheme

- Polarized positrons have been obtained in high energy storage ring taking advantage of the ~~Sokolov-Ternov~~ effect which leads to ~~positrons polarized parallel to the magnetic field.~~



Polarization builds up exponentially with a time constant characteristic of the energy and the curvature of the positrons

$$\tau = \frac{8}{5\sqrt{3}} \frac{m_e^2 c^2}{\hbar e^2} \frac{\rho^3}{\gamma^5}$$

$t \sim 20 \text{ mn} @ \text{HERA}$

Not compatible with CW beam delivery at JLab.

# Fixed Target Schemes

- The principle of **polarization transfer** from **circular photons** to **longitudinal positrons** has been demonstrated in the context of the ILC project.

## Compton Backscattering

T. Omori et al, PRL 96 (2006) 114801

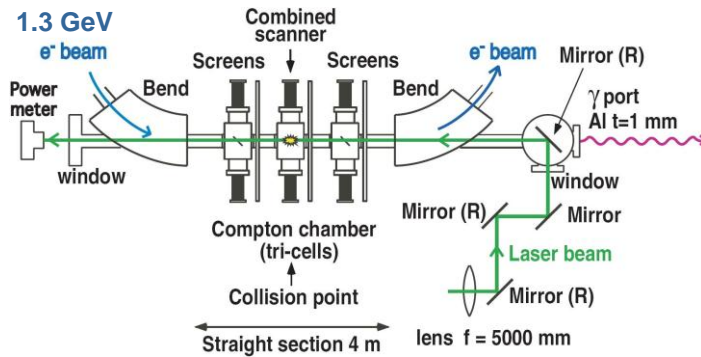

$$P(e^+) = 73 \pm 15 \pm 19 \%$$

## Undulator

G. Alexander et al, PRL 100 (2008) 210801

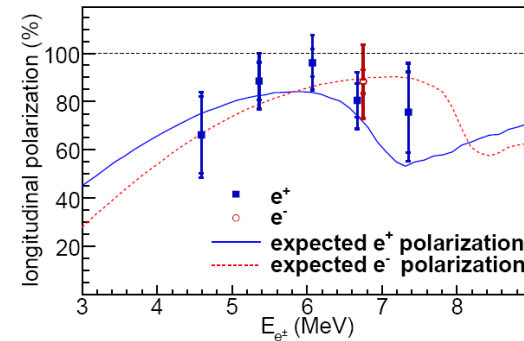
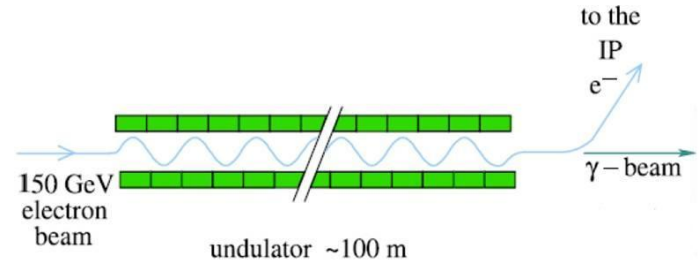

# Fixed Target Schemes

- The principle of **polarization transfer** from **circular photons** to **longitudinal positrons** has been demonstrated in the context of the ILC project.

## Compton Backscattering

T. Omori et al, PRL 96 (2006) 114801

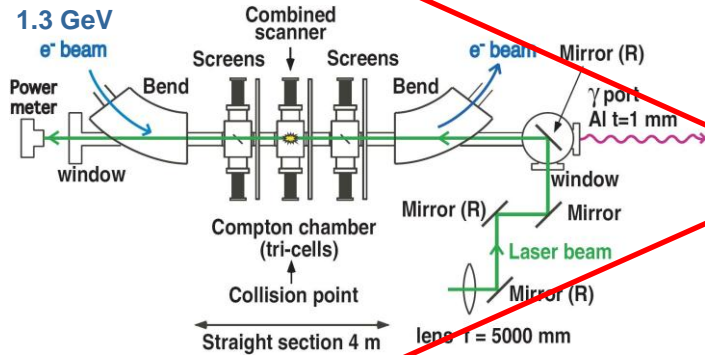

$$P(e^+) = 73 \pm 15 \pm 19 \%$$

## Undulator

G. Alexander et al, PRL 100 (2008) 210801

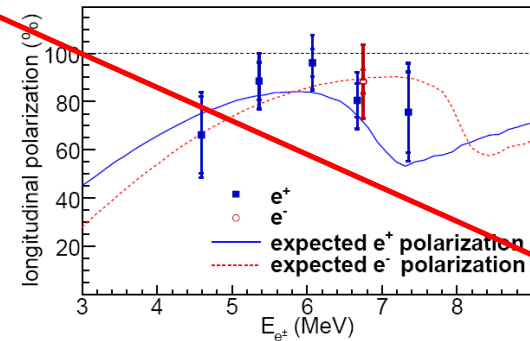
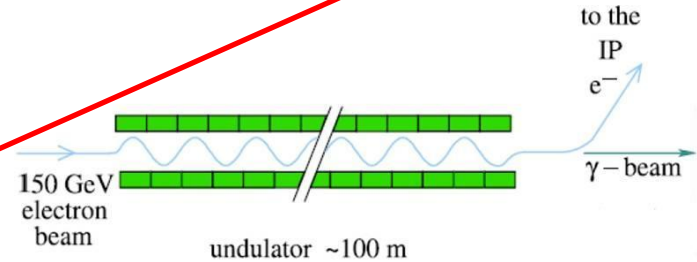

Require independent ~GeV to multi-GeV electron beam.

# Target Ladder

➤ The PEPPo target ladder constitutes of **3 tungsten** production targets with **different thicknesses** and a **viewer**. It is **water cooled** to allow for maximum beam currents.

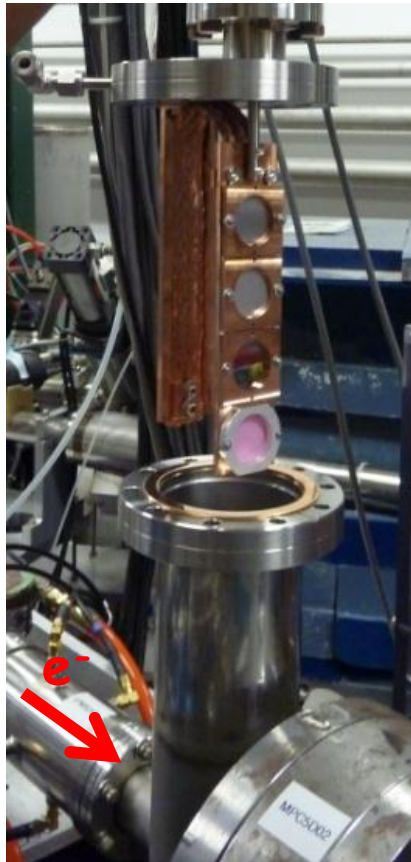

Incoming electron kinetic energy [MeV]		2	5	8	Necessary for Experiment [uA]
		Max Current [uA] for 5W deposited			
Target	Material				
Production Target = 0.1mm	Tungsten	15.9	27.6	30.1	4.0
Production Target = 0.5mm	Tungsten	5.0	3.0	3.7	n/a
Production Target = 1mm	Tungsten	4.9	2.0	1.6	0.4

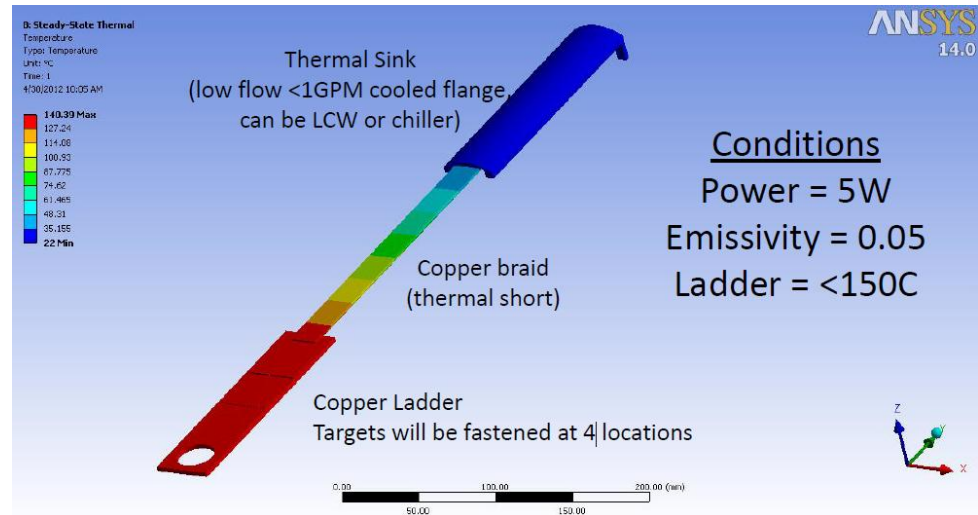

## Compton Transmission Polarimeter

➤ PEPPo polarimetry relies on the **sensitivity** of the **Compton** process to the **polarization** of the **photons** generated in the  $T_2$  target from **interactions** of **incoming electrons/positrons**.

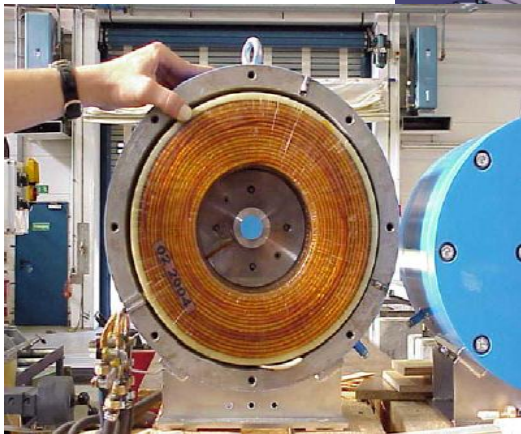
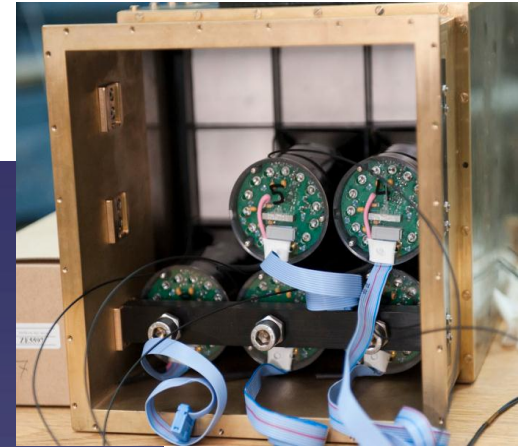
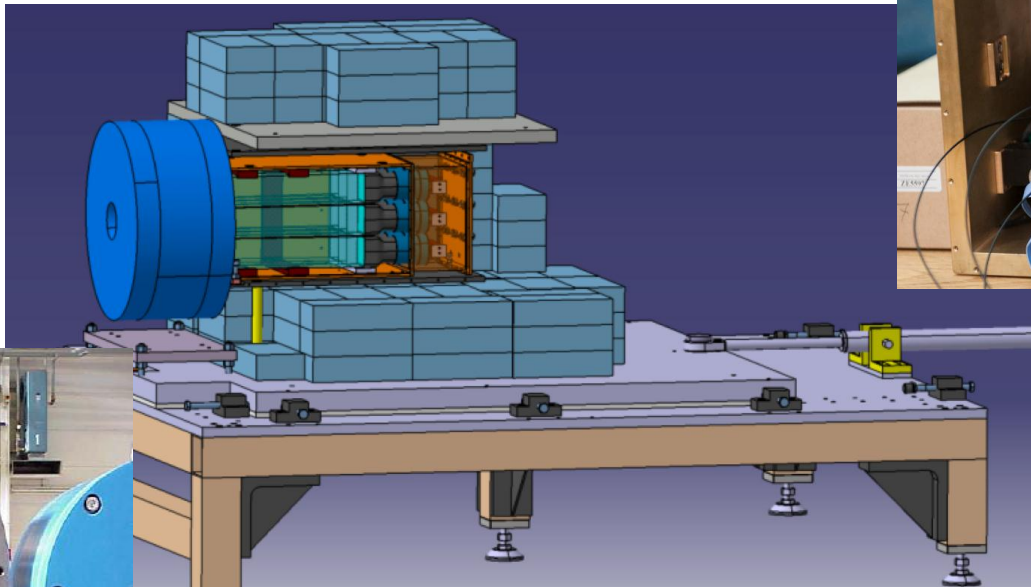

$$A_T = P_{e^\pm} P_T A_{e^\pm}$$

Expected experimental **asymmetries** are small ( $1-8 \times 10^{-3}$ )



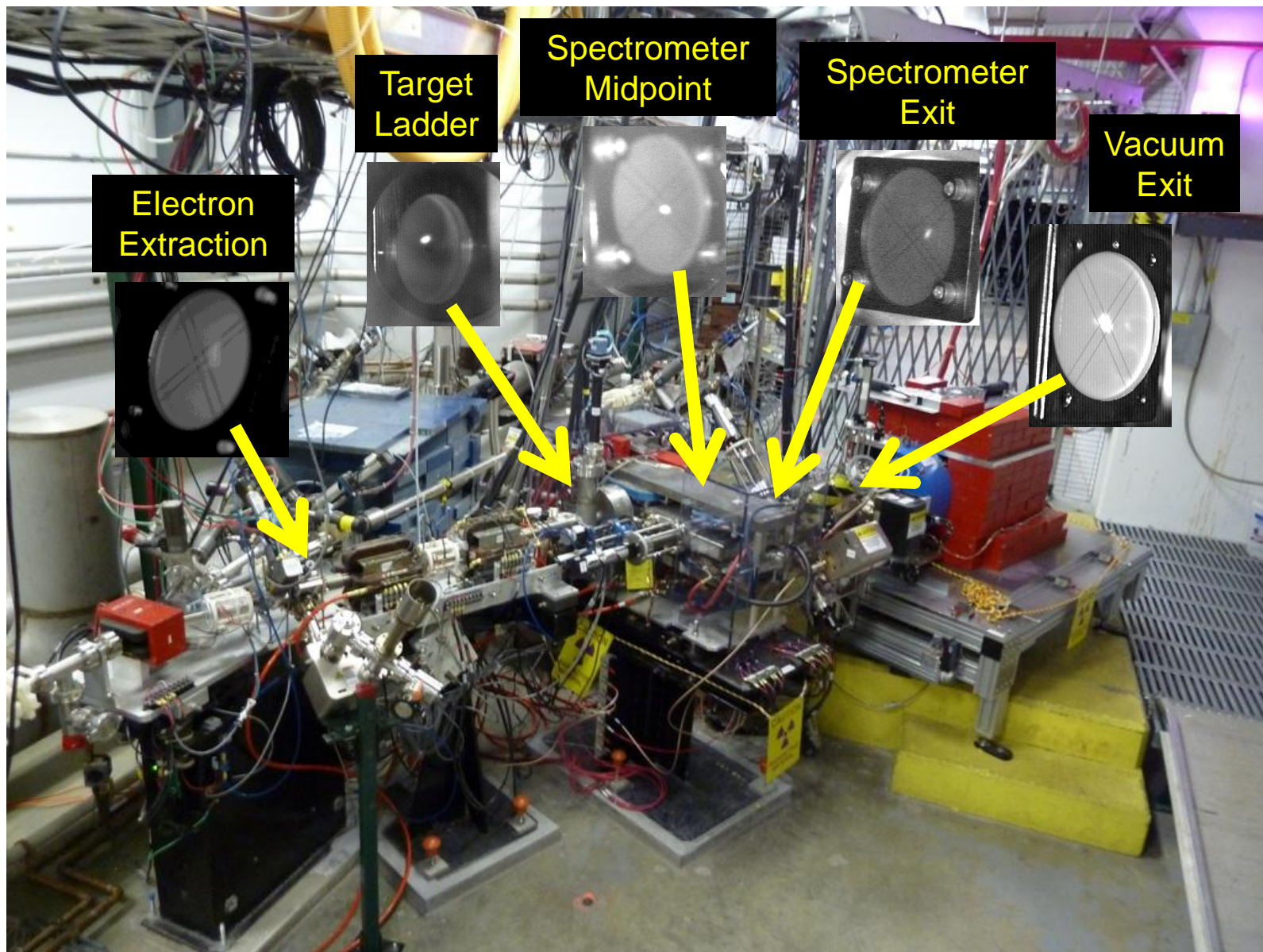

$4\pi$  spin rotator determines  $e^-$  polarization orientation

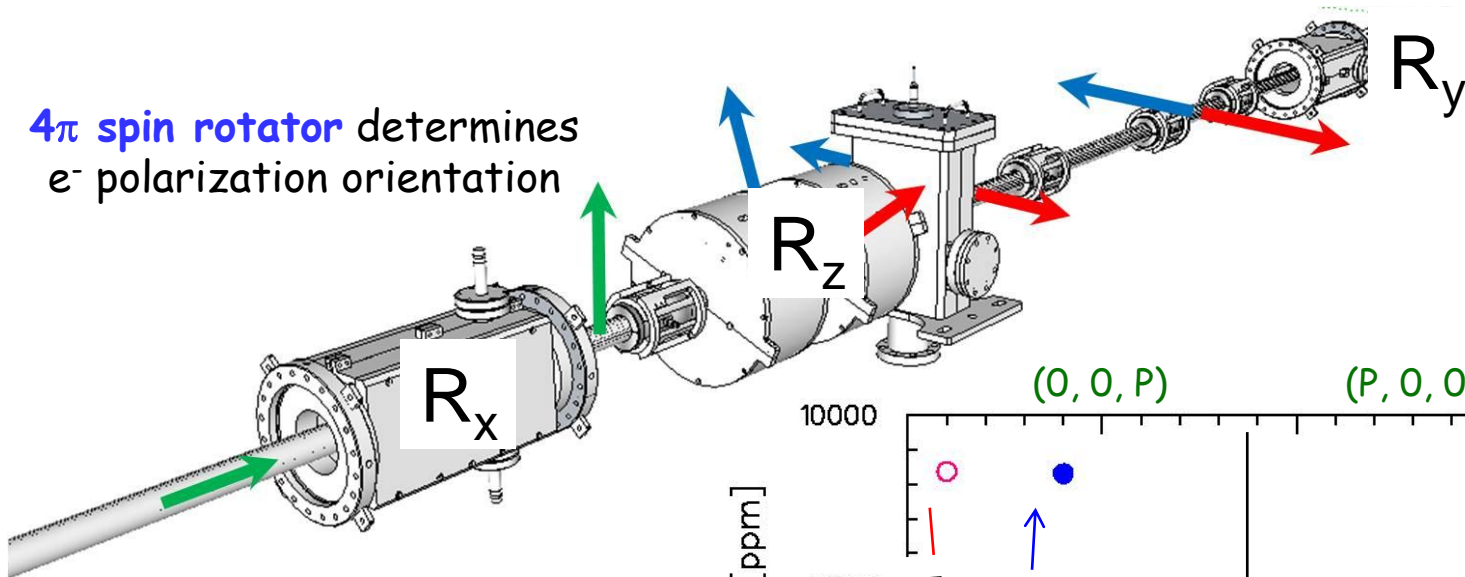

- **Fast reversal** of electron **beam polarization** at 30 Hz through experiment.

- **Slow systematic reversal** of electron polarization with **optical wave-plate** (source) and **target polarization** (Compton).

- **Orient polarization** in  $x,y,z$  direction using  $4\pi$  spin rotator.

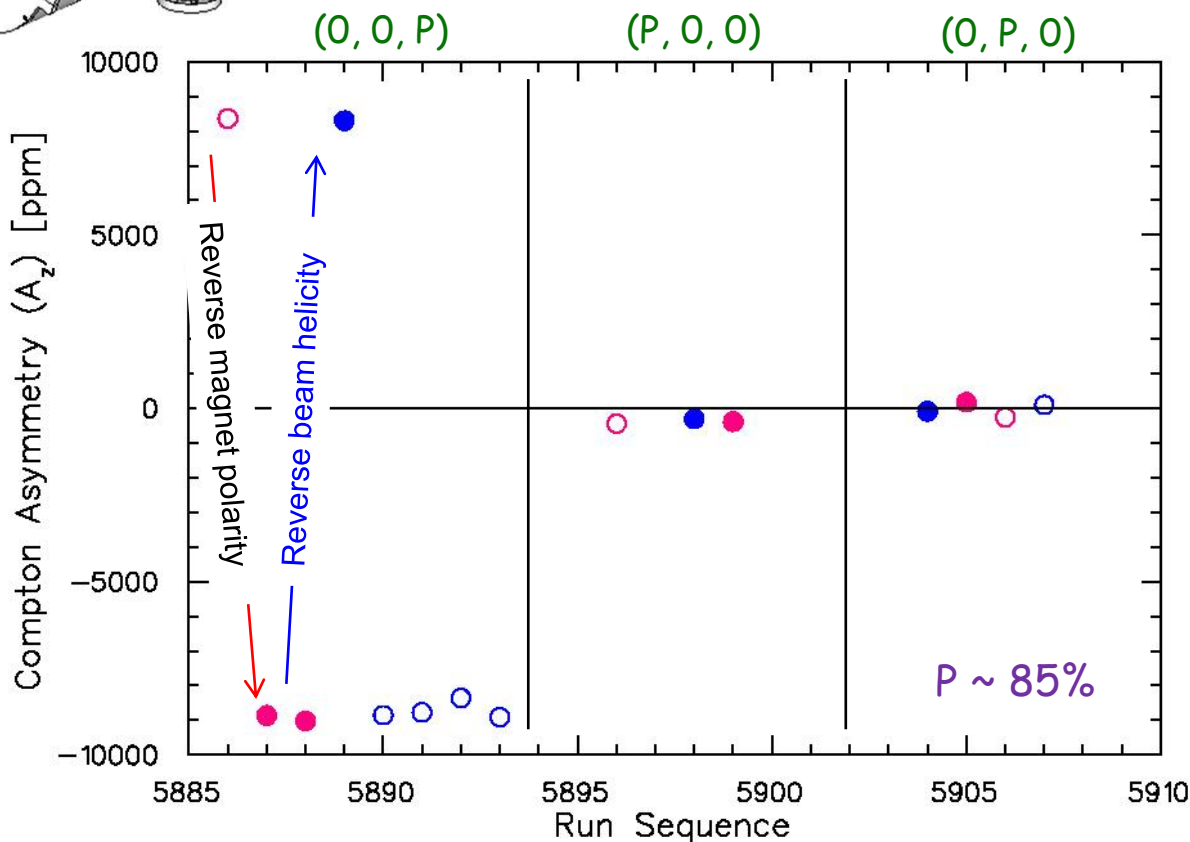

# Analyzing Magnet Model

$$P_T = 2 \frac{g^c - 1}{g^c} \frac{B[T] - B_0[T]}{r_e m_0 m_b} \text{ £ } 0.0819$$

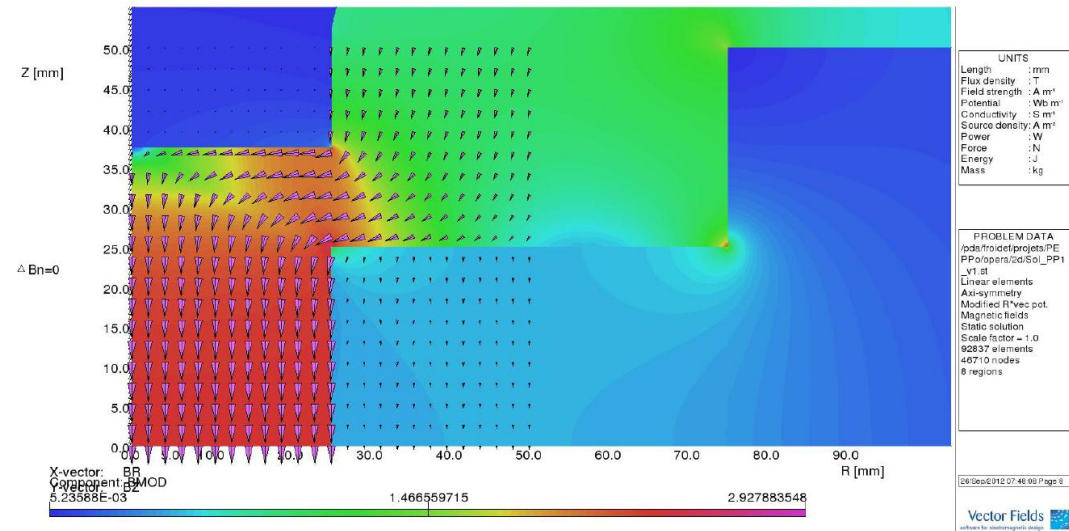
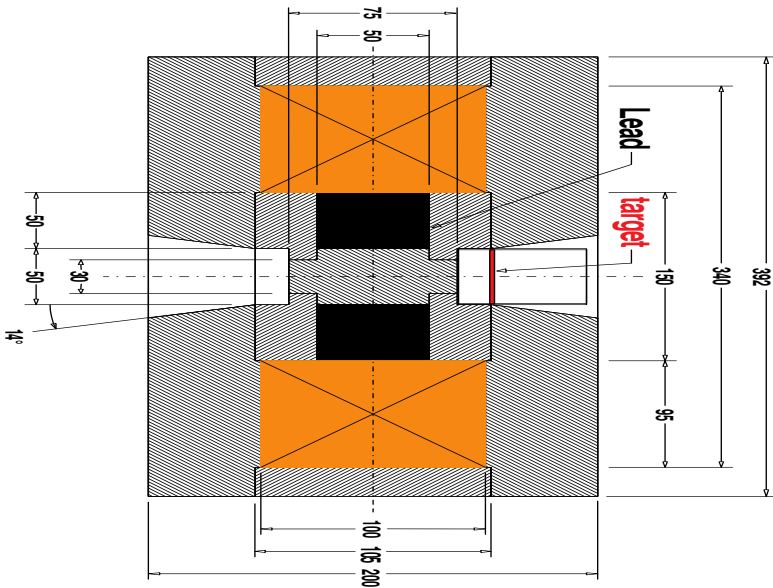

➤ The **model** of the analyzing magnet developed within **OPERA-2D** is controlled by the **measured magnetic map** of the **fringe field** of the solenoid at **±60 A** operational current.

## Magnetic Flux Measurement

- The iron core target is equipped with **3 pick-up coils** measuring the magnetic flux generated by the magnet **current** variation (**ramping-up**, polarity reversal).
- Specific **cycling procedures** are used during the experiment to monitor the **target polarization**.

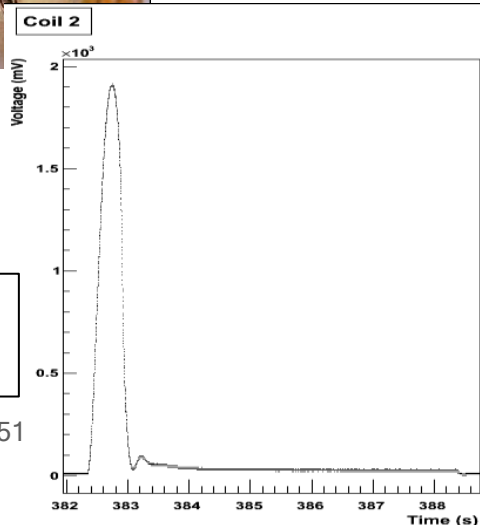
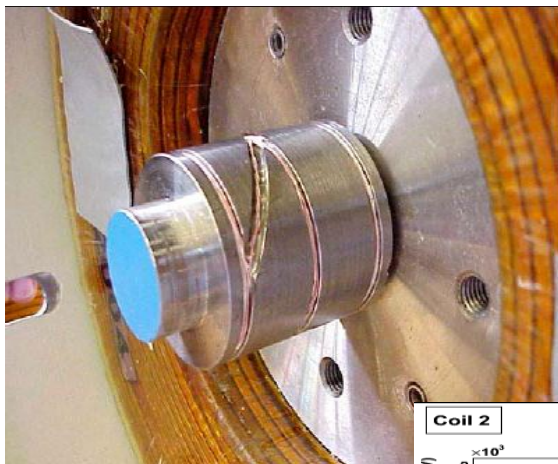

From E-166@SLAC  
 $\langle P_T \rangle = 0.069 \pm 0.002$

G. Alexander et al., NIM A610 (2009) 451

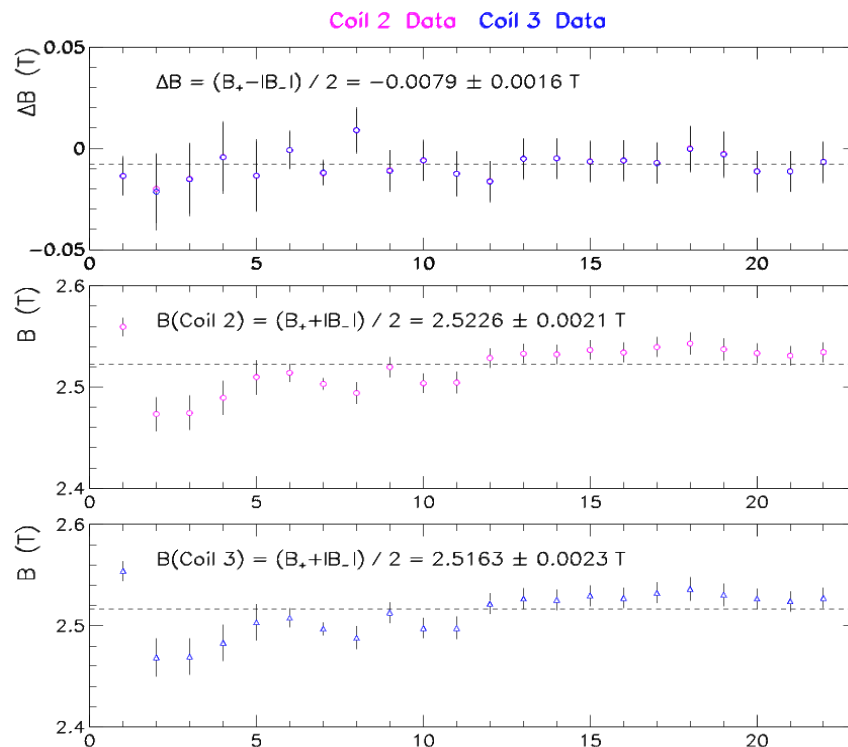

**Under progress...**

# Energy Dependent Asymmetry

*e<sup>+</sup> Data @ 6.3 MeV/c*

Raw Asymmetry

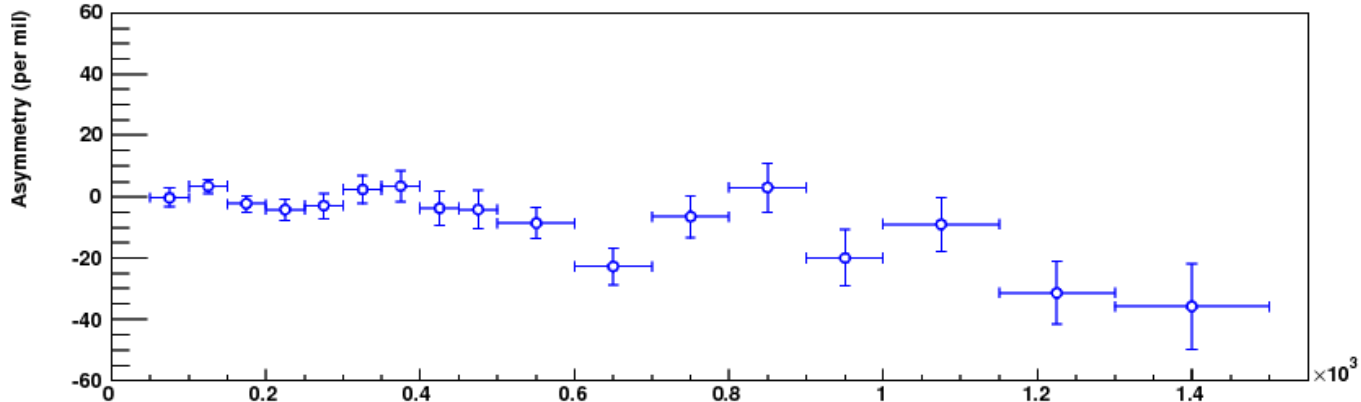

Compton Asymmetry

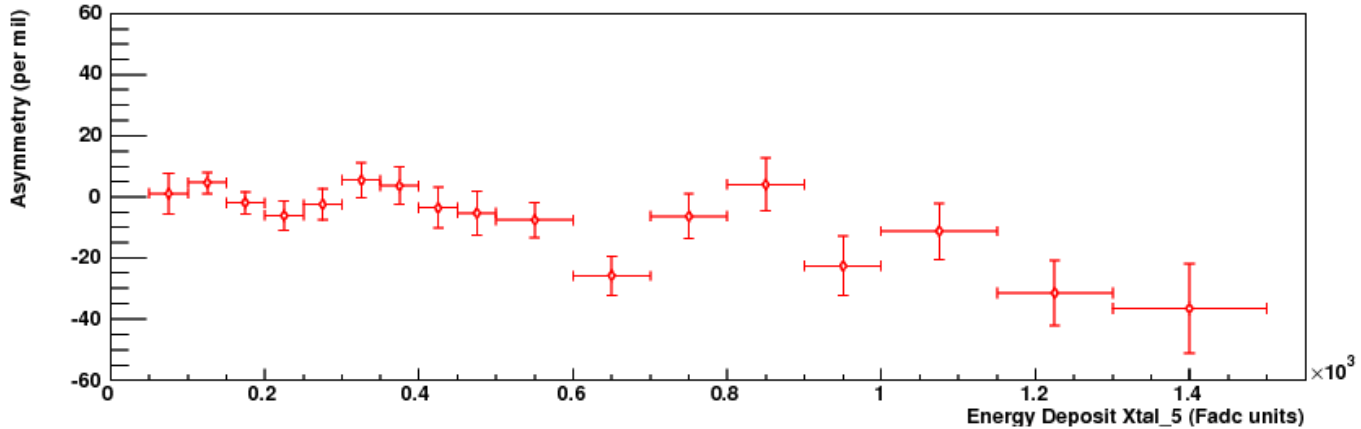

➤ **Statistics** corresponds to **1/72** of data at this energy.

**Under progress...**