

Studies on An S-band Bunching System with Hybrid Buncher

Shilun Pei

Institute of High Energy Physics, China

May 14, 2013 at IPAC'13, Shanghai



IPAC 上海 **13**

The 4th International Particle Accelerator Conference

第四届国际粒子加速器会议

Shanghai China
12-17 May 2013
Shanghai International Convention Center





Outline

- @ Background
- @ Beam Dynamics Study
- @ Hybrid Buncher Design
- @ Summary

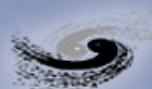

Background

- IHEP is constructing a 100MeV/100kW electron linac (625Hz/2.7 μ s/600mA) with standard bunching system for NSC KIPT, Ukraine.
- Initially, the Buncher (B) is a 4-cell TW CI structure with $\beta=0.75$. However, the adoption of water cooling jacket demands more longitudinal space (a longer B) to ease the mechanical installation. Finally, a 6-cell version was fabricated and used.
- Inspired by the idea of hybrid photo-injector developed by the INFN-LNF/UCLA/SAPIENZA collaboration, we propose one alternative design to simplify the nominal/standard bunching system— replace the Pre-buncher (PB) and B with the Hybrid Buncher (HB), which is a combined structure of the SW PB and the TW B.

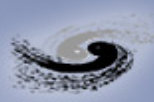

Bunching System

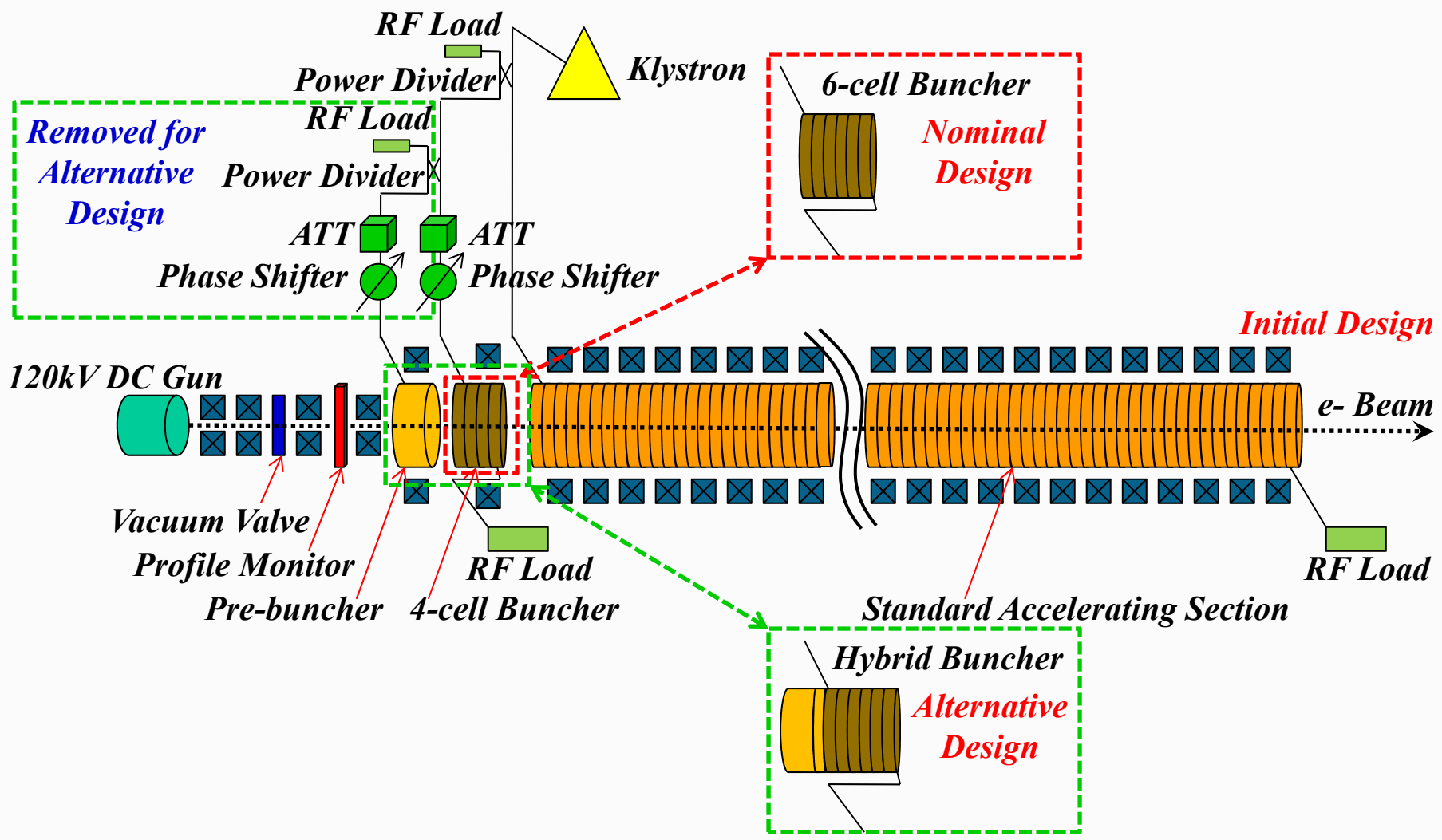



Pros and Cons

● Pros

- More compact than a split system, allows scaling to higher frequency for a table-top system in industrial applications.
- Much simpler high power RF system. Some waveguide section, attenuator, phase shifter, RF load can be avoided to lower the total construction cost.
- More flexible in the whole system installation and tuning, less parameters need to be adjusted and optimized.
- Completely removal of the impedance matching problem during the PB design and fabrication process, therefore the RF reflected power in operation.

● Cons

- Slight degradation of the beam performance.
- Demands relatively accurate calculation of the longitudinal distance between the SW and TW parts, which is based on the gun emitted beam energy.



Design Consideration

- To be comparable with the split bunching system (nominal design), the TW part of the HB was also designed to have 6 cells.
- To satisfy the energy spread requirement ($< \pm 4\%$ p-to-p) at the 100MeV/100kW linac exit, the bunching system with HB (alternative design) should be able to produce similar energy spectrum as the nominal design, which is appropriate for the downstream collimation process. In the mean time, 600mA beam (70% efficiency) should be able to be obtained after collimation.

Nominal Bunching System

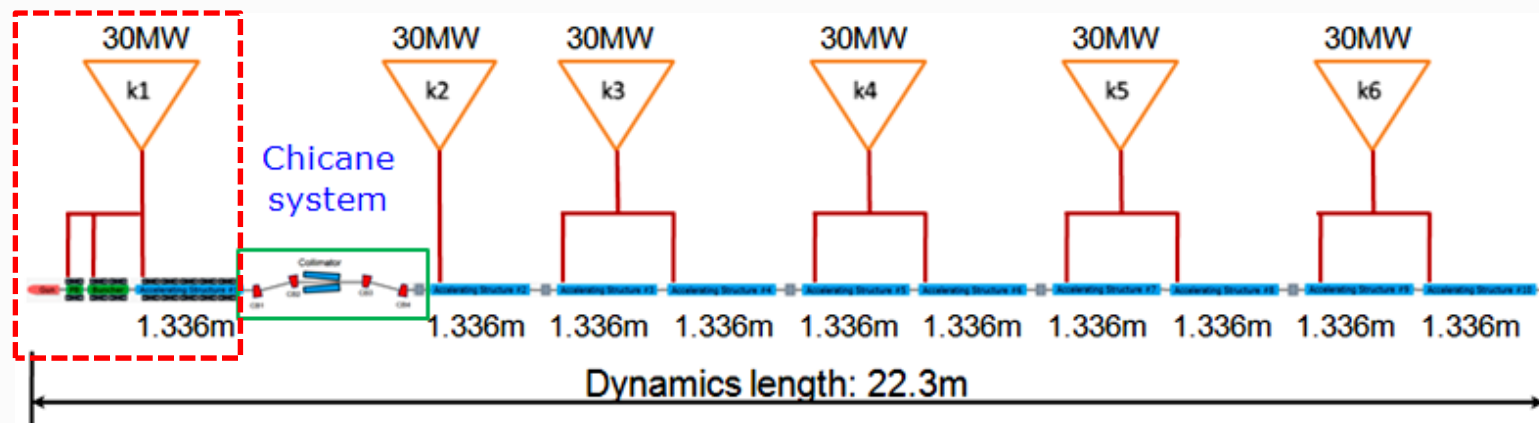

Schematic Layout of the 100MeV/100kW Electron Linac



Initial 2D Design of the HB

- To accommodate RF field data to Parmela, the initial 2D design of the SW and TW parts were performed separately with appropriate boundary conditions.

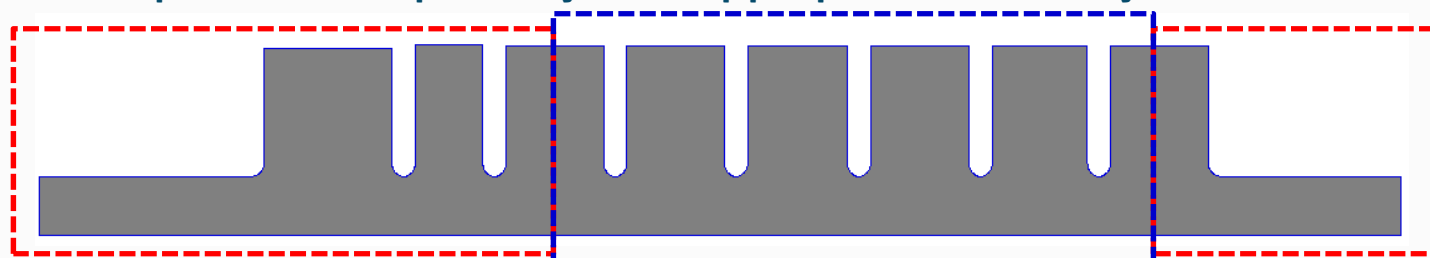

Left SW part with $\pi/2$ mode

Middle TW part with $2\pi/3$ mode

Right SW part

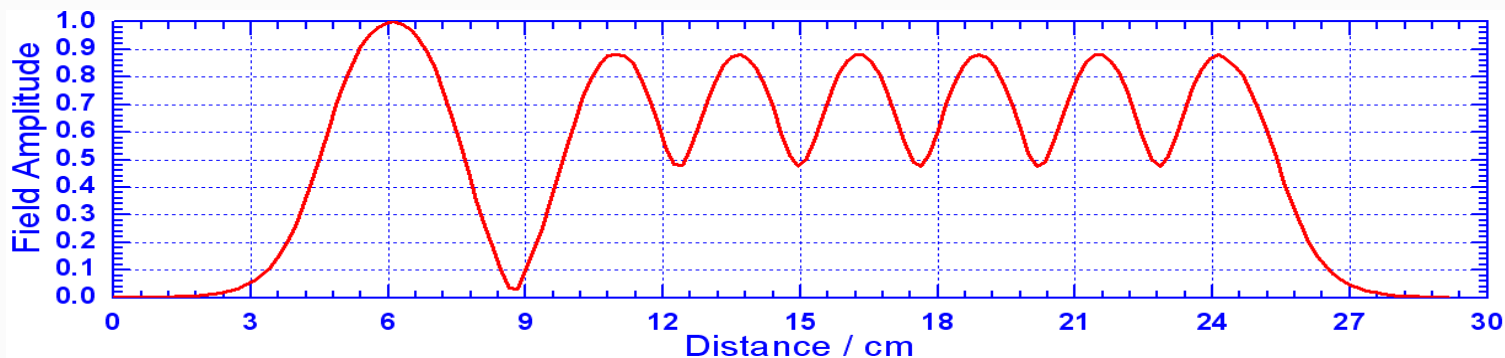
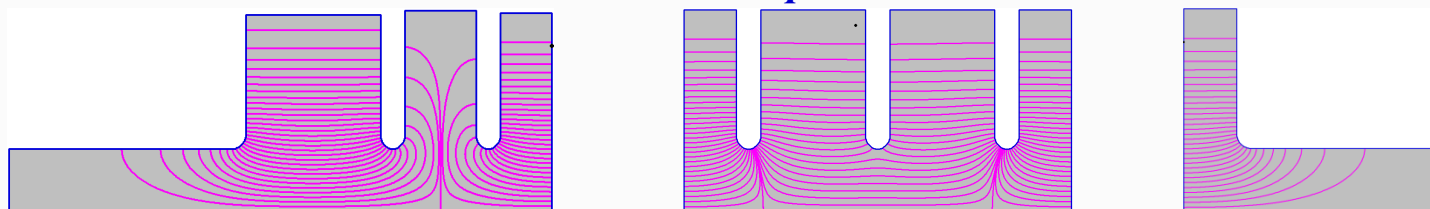



Dynamics Simulation

- With the RF field obtained from the 2D RF design, the bunching system is optimized to check the energy spectrum at the system exit. After several iterations between 2D RF design and dynamics simulation, the 2D version of the HB can be finalized as the starting point of the 3D RF design.

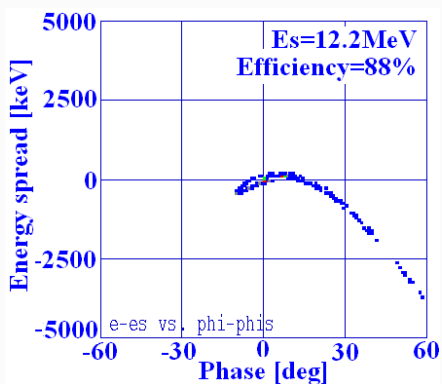

Before collimation

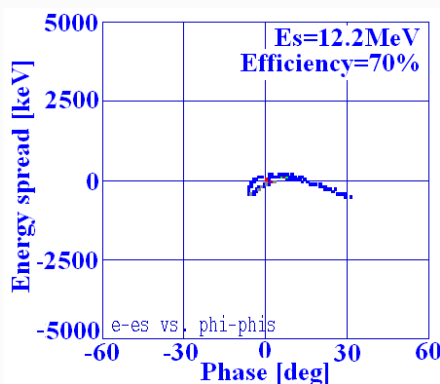

After collimation

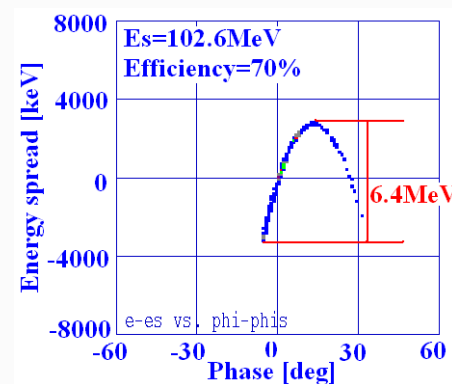

Linac exit

Energy spectrums for the nominal bunching system

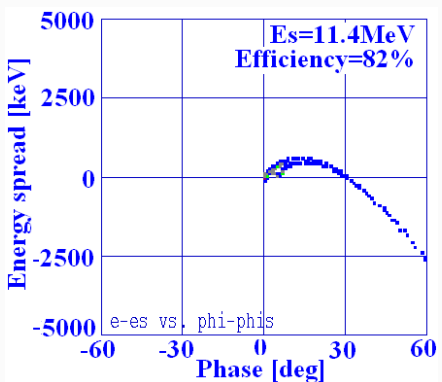

Before collimation

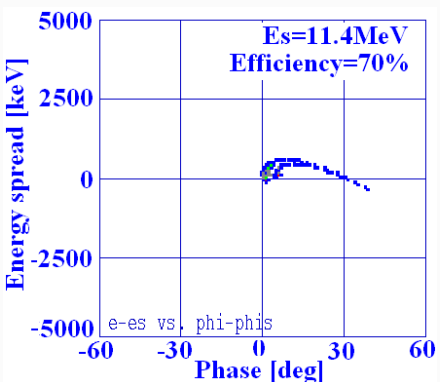

After collimation

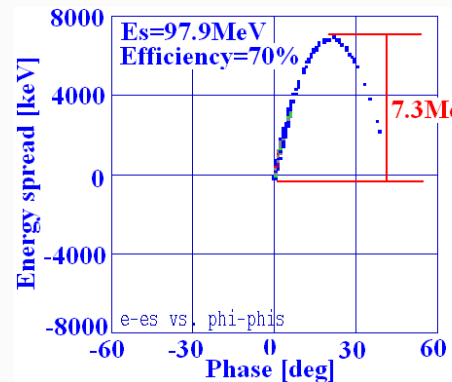

Linac exit

Energy spectrums for the bunching system with Hybrid Buncher

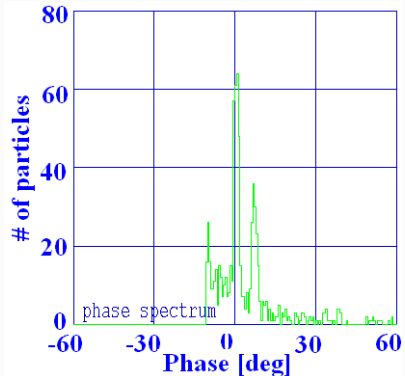
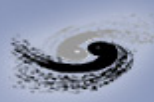

Before collimation

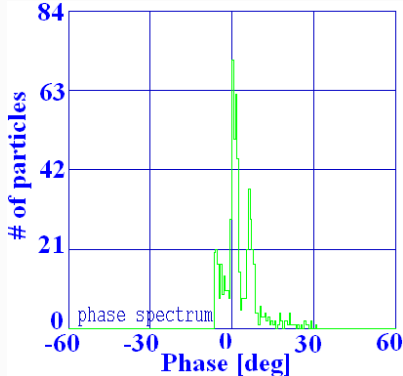

After collimation

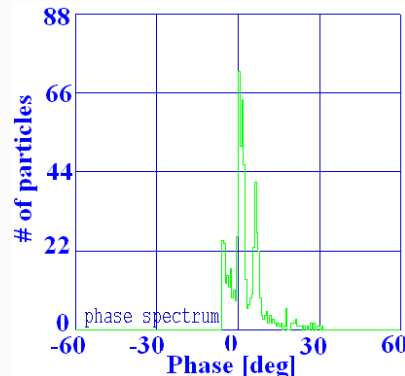

Linac exit

Phase spectrums for the nominal bunching system

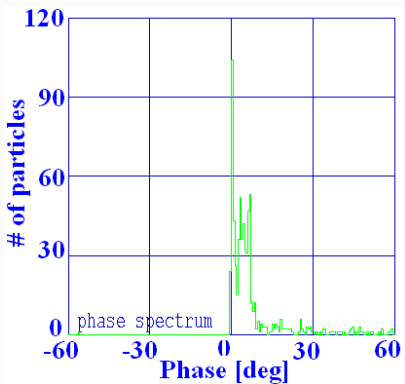

Before collimation

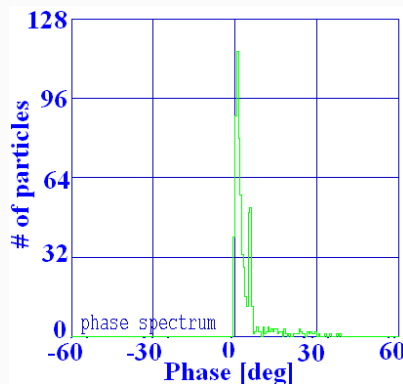

After collimation

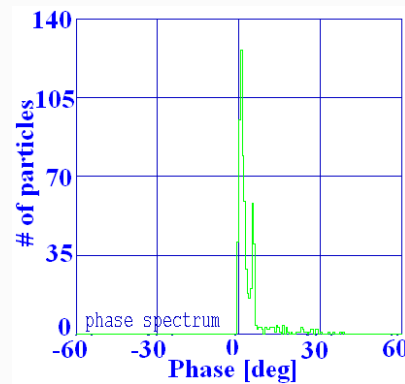

Linac exit

Phase spectrums for the bunching system with Hybrid Buncher

- By using the bunching system with hybrid buncher, a shorter bunch length can be obtained with slightly degraded efficiency at the system exit and relatively bigger energy spread at the linac exit.



Energy Spread Evolution along the Linac

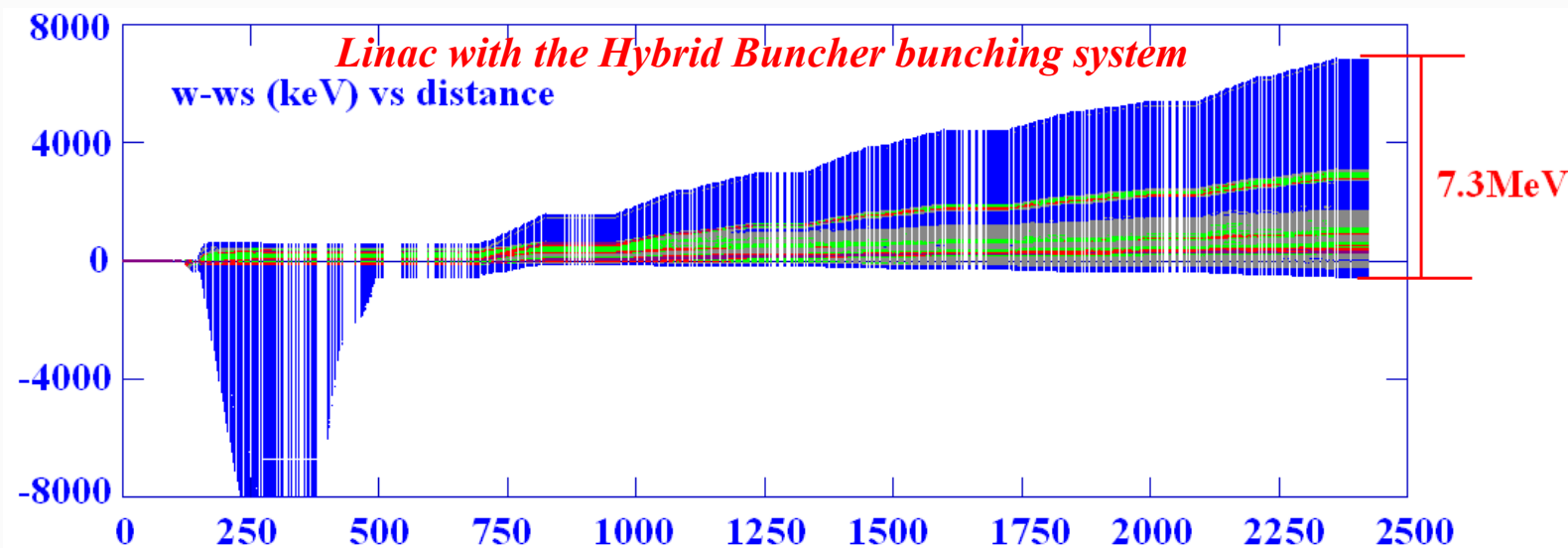
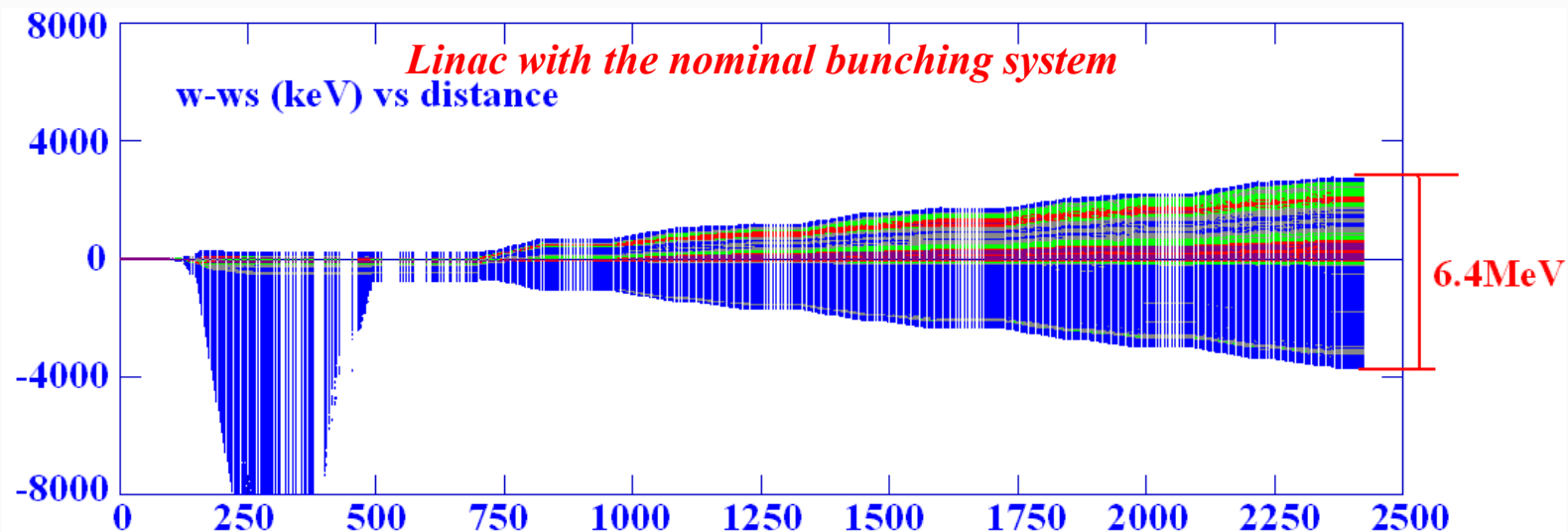

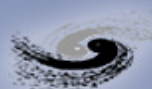

Beam Envelope (X) Evolution along the Linac

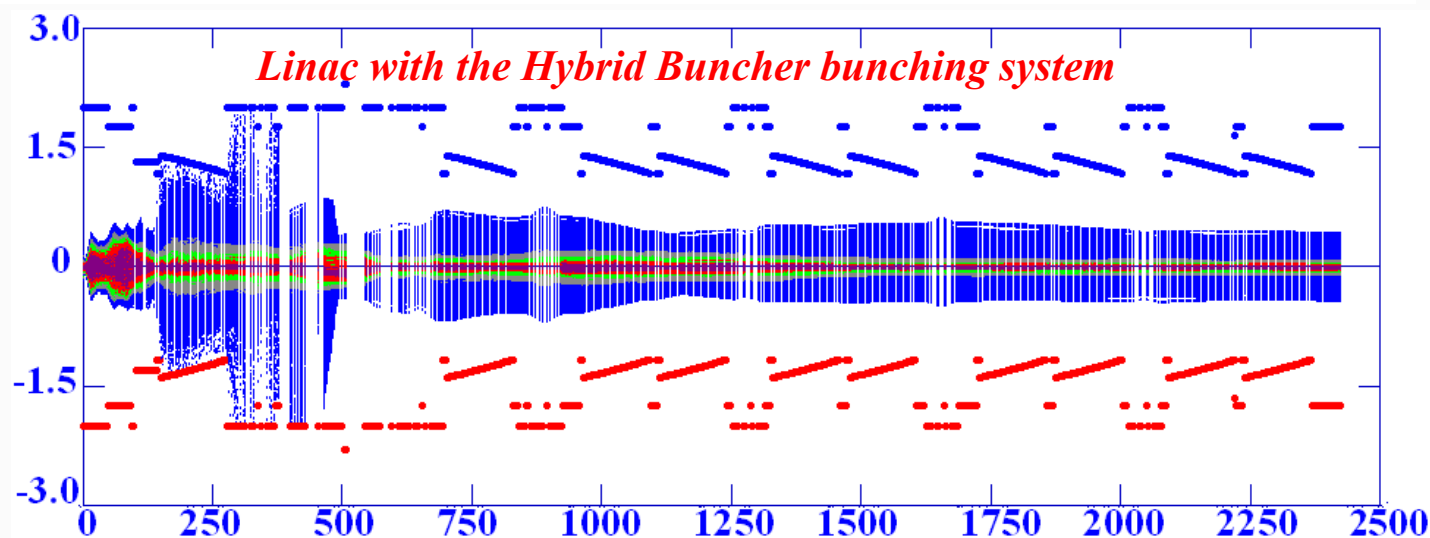
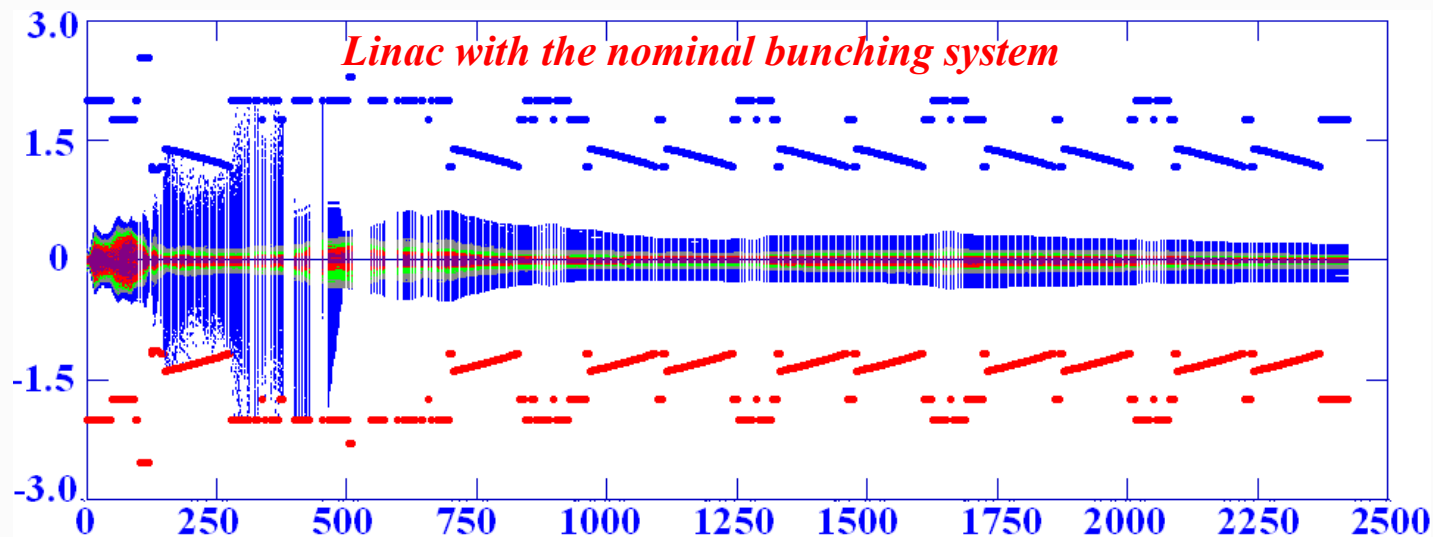

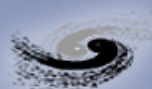

Beam Envelope (Y) Evolution along the Linac

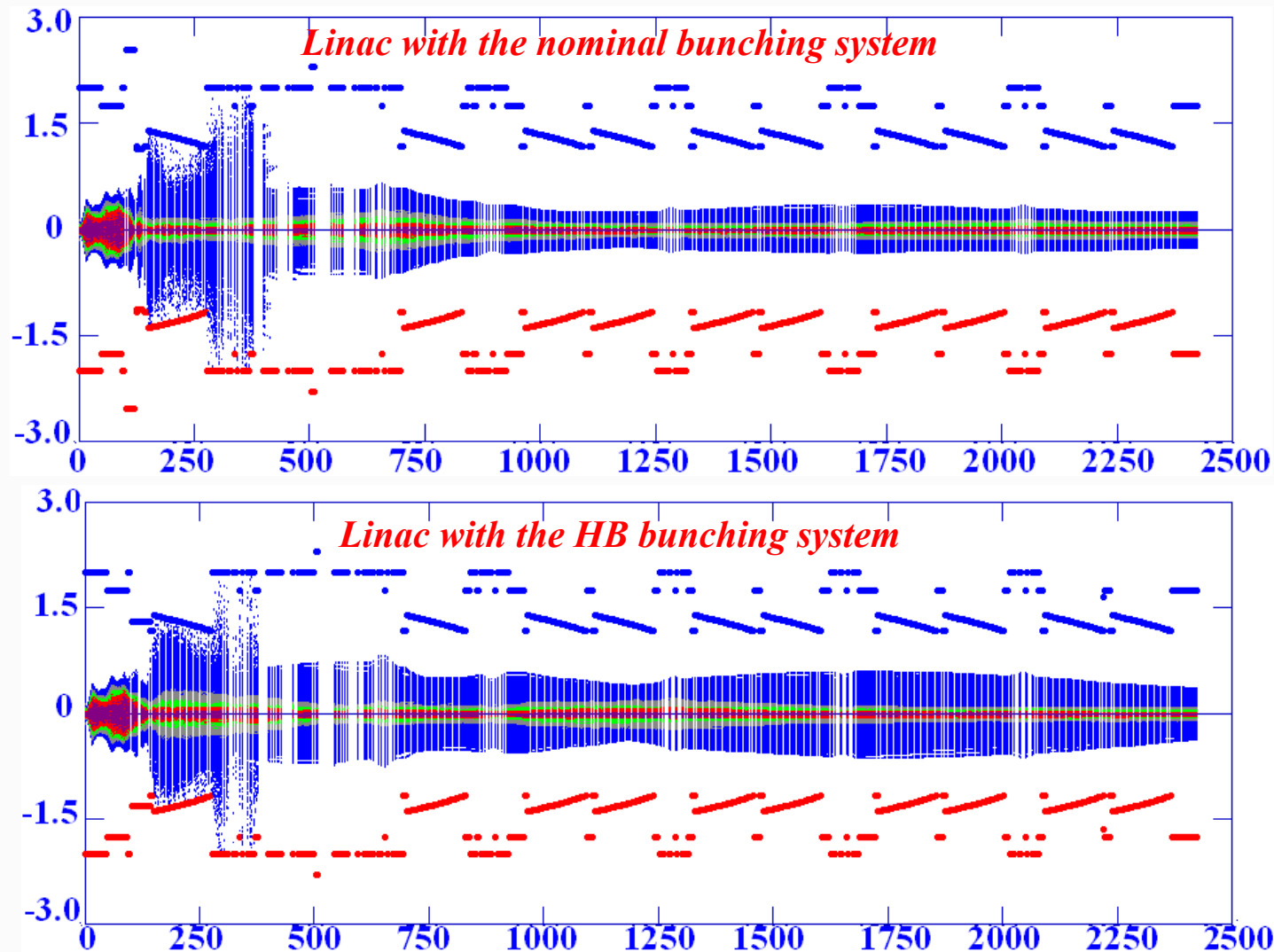

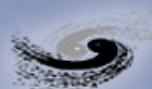

Emittance Evolution along the Linac

- By using the bunching system with hybrid buncher, the emittance at the linac exit is ~37% bigger, which is caused by the bunching process and can be reduced by further optimization of the hybrid buncher structure.

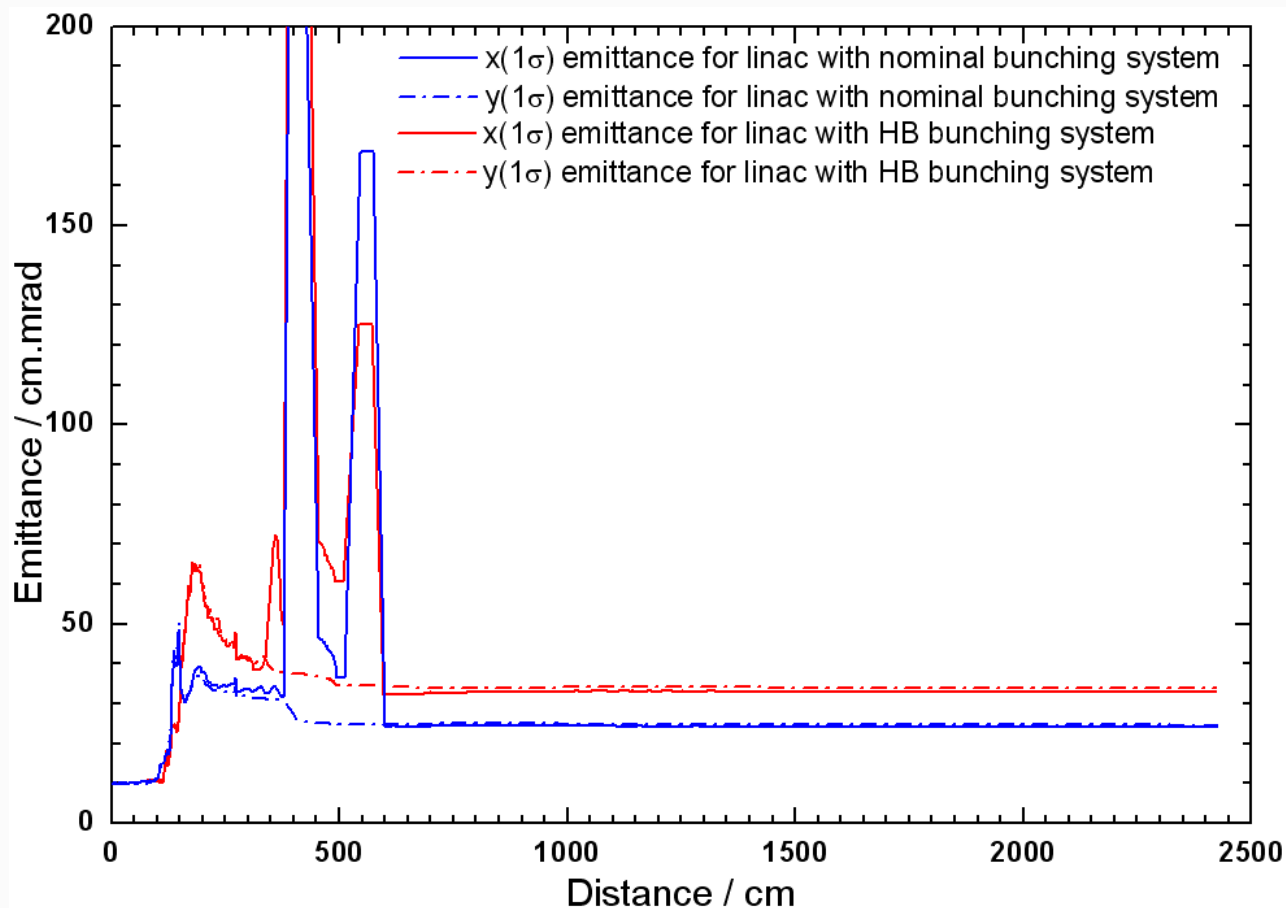

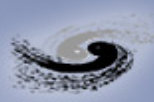

3D Design of the Hybrid Buncher

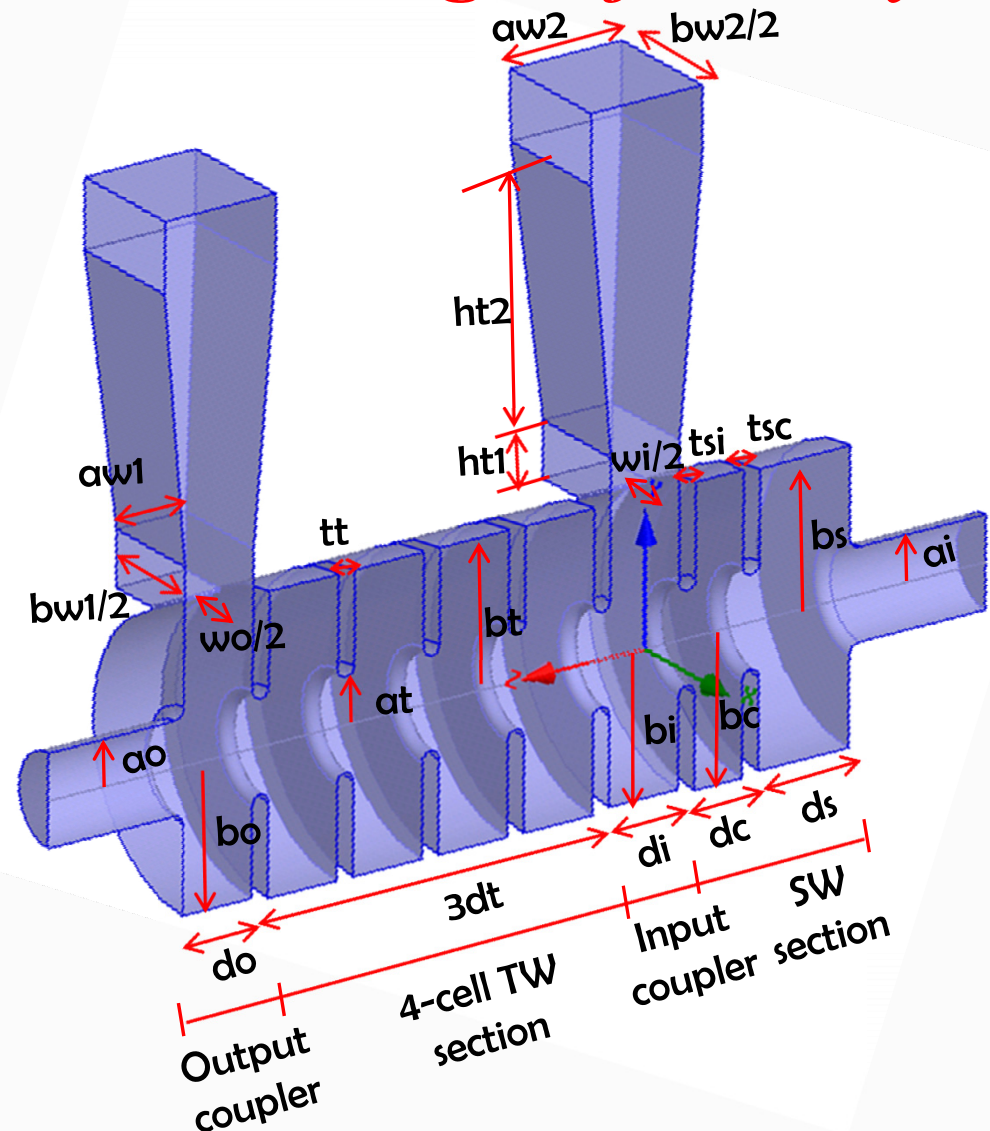

Parameter	Value[mm]
ds	32.803
dc	19.682
di, dt, do	26.242
ai, at, ao	13.11
bs	41.556
bc	42.442
bi, bo	41.045
bt	42.195
tsc, tsi, tt	5
wi, wo	30.08
ht1	15.9
ht2	76.2
aw1	21.242
bw1	61.087
aw2	34.163
bw2	72.263

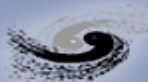

3D Design of the SW Section

- The SW section can be further divided into two parts: pre-bunching cavity part and coupling cavity part. The former one is used for beam velocity modulation, while the latter one as a beam drift. Both operate at $\pi/2$ mode.

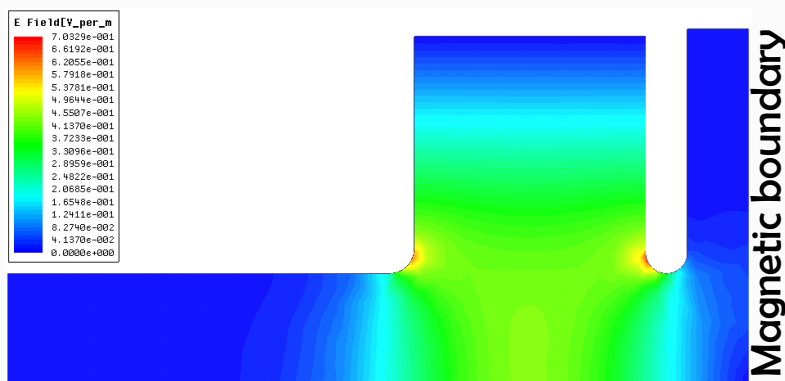

Pre-bunching cavity

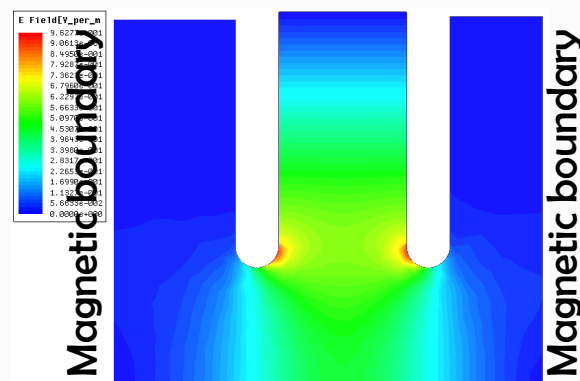

Coupling cavity

Length of each cavity is based on the initial 2D design and decided by the beam dynamics requirement.

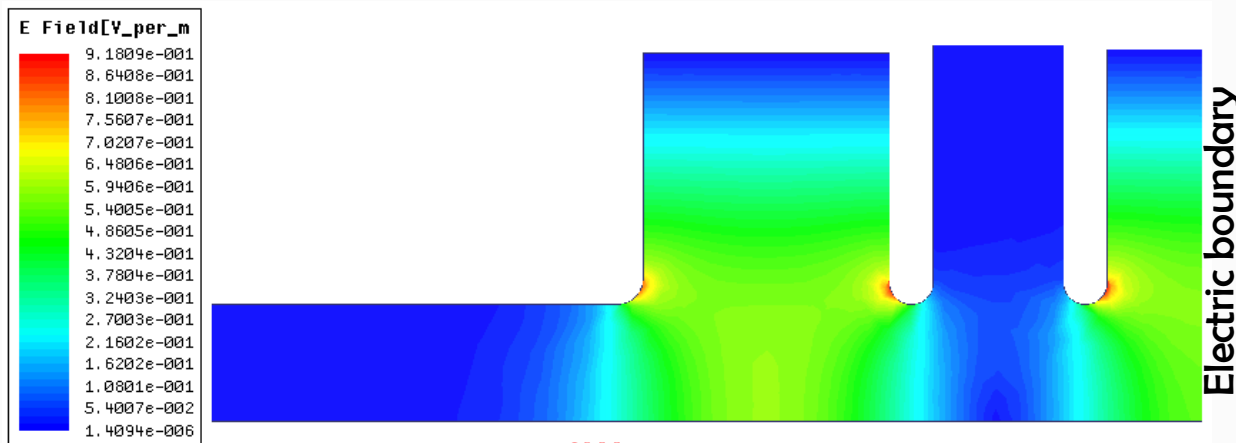

SW section

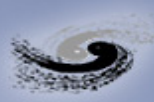

3D Design of the TW Section

- The coupler matching of the TW section is based on the matching procedure for the $2\pi/3$ structure proposed by Dr. R. L. Kyhl and confirmed with the field transmission method.

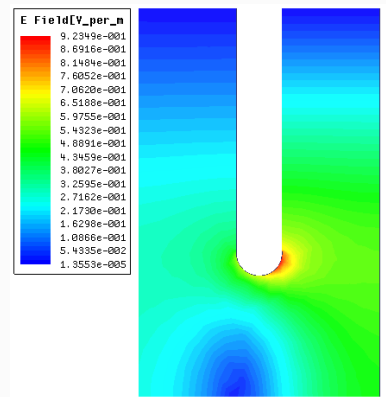

Regular cell ($2\pi/3$ mode)

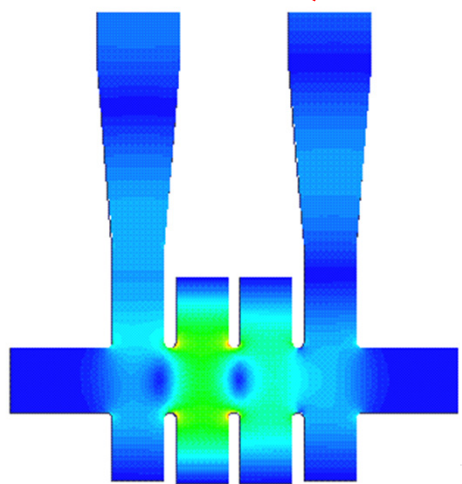
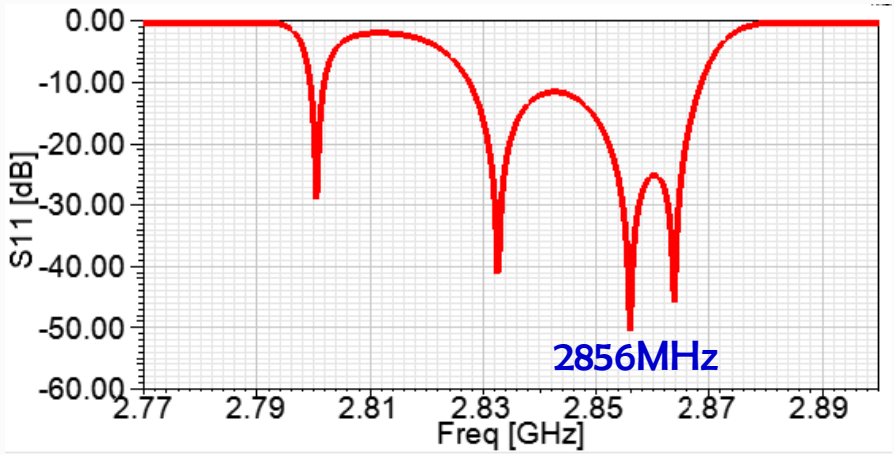

TW field animation ($2\pi/3$ mode)

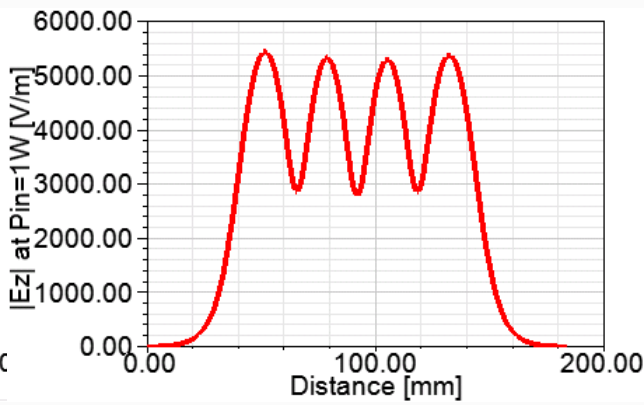
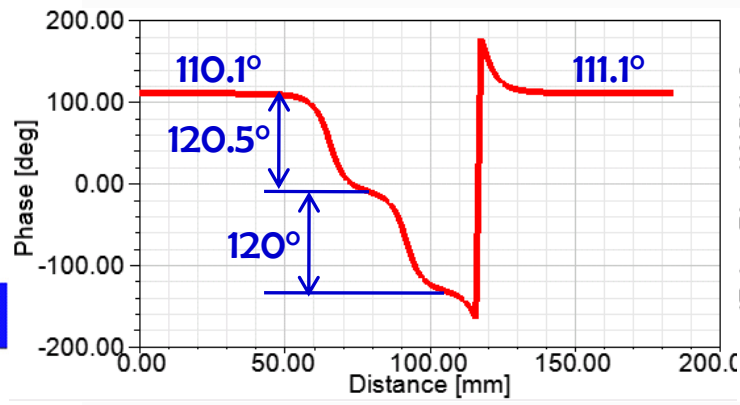

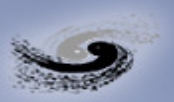

RF Property of the Whole Hybrid Buncher

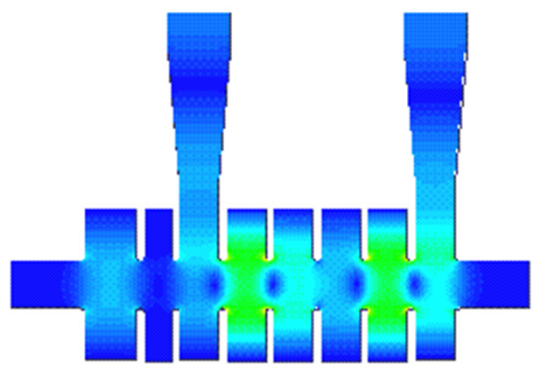

Field animation

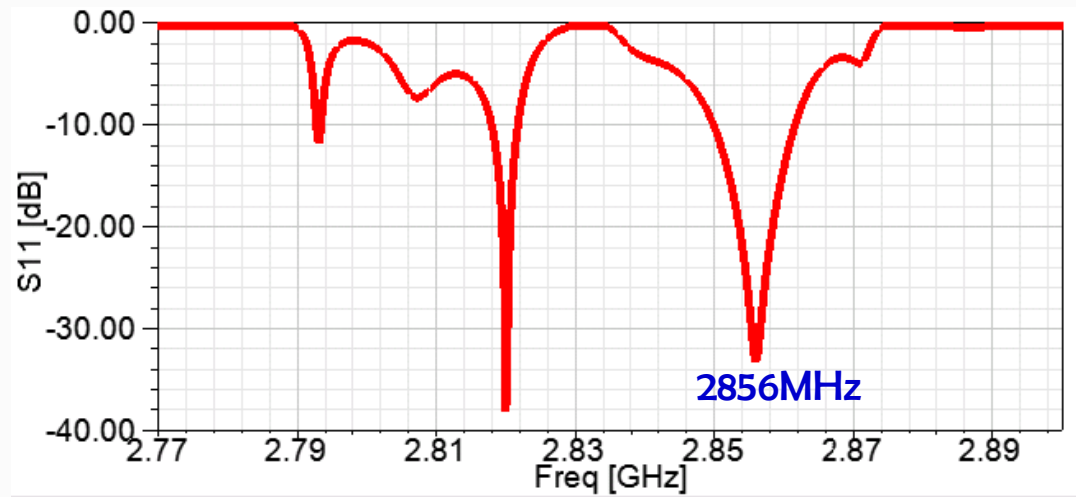

- To excite the RF field required by beam dynamics, the needed RF power is ~0.7MW. ~3% goes to the SW section, the rest to the TW section.

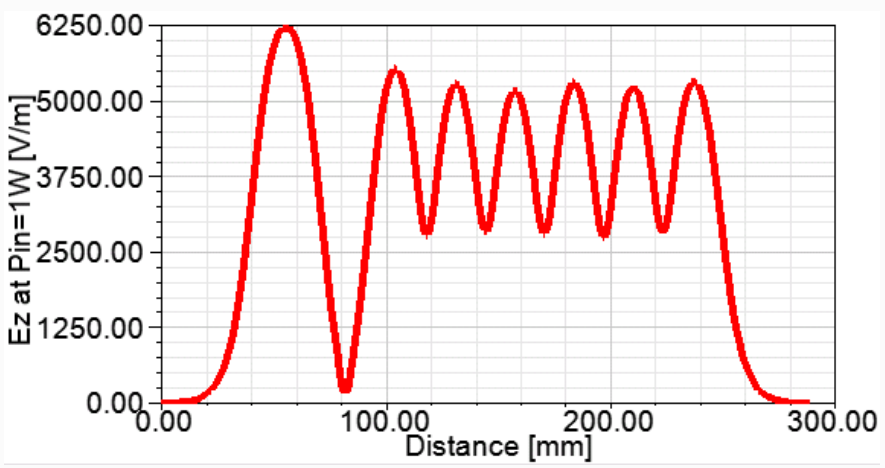
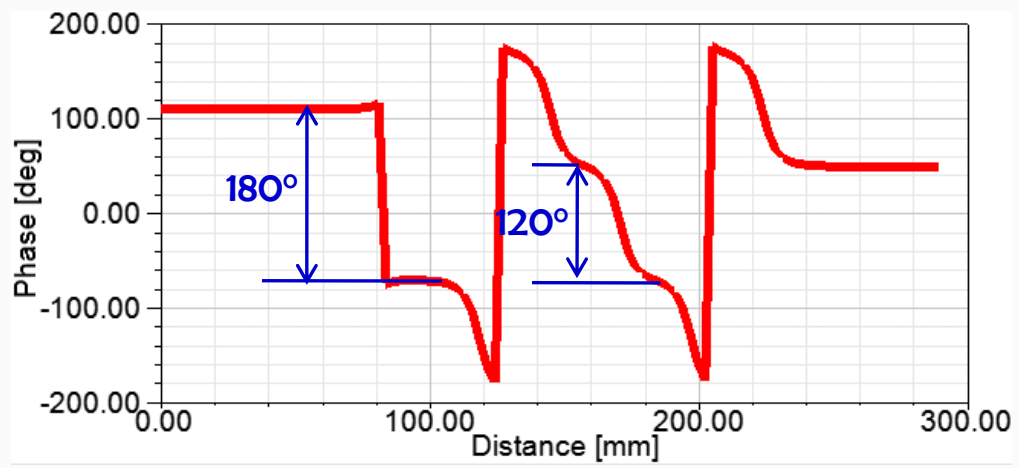



Field Distribution Comparison with Parmela

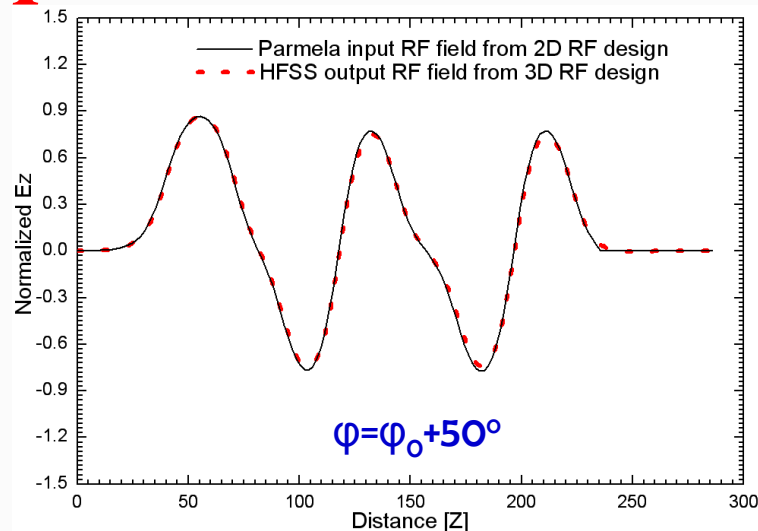
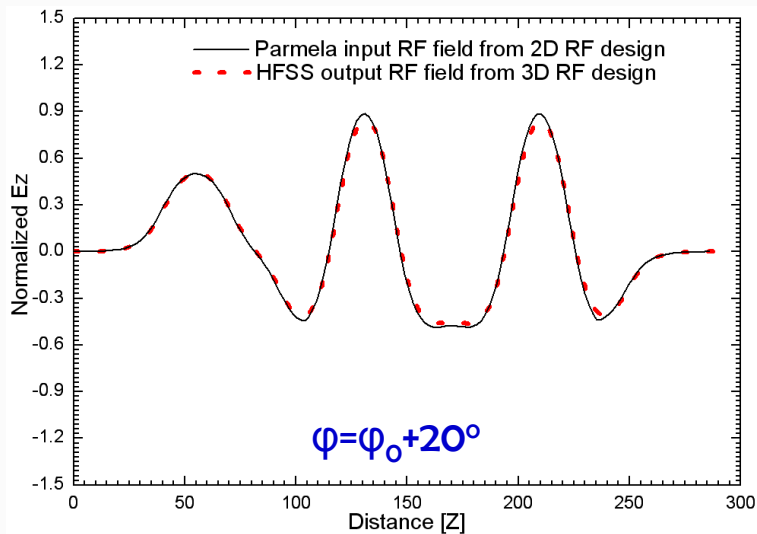

The RF design of the Hybrid Buncher satisfies the beam dynamics requirement!

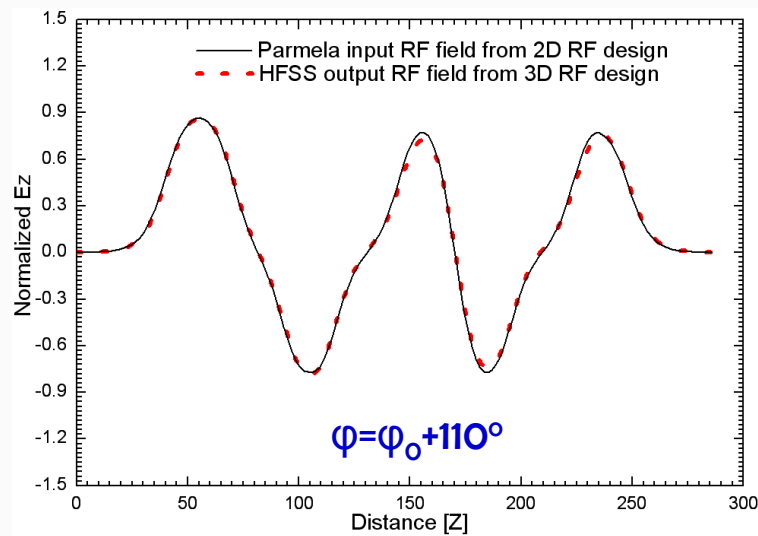
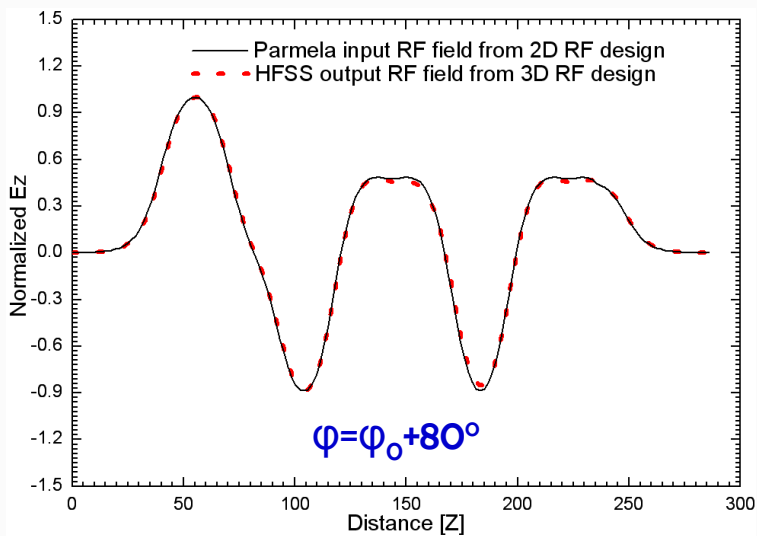

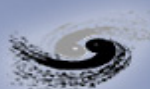

Sensitivity on the SW Section Frequency

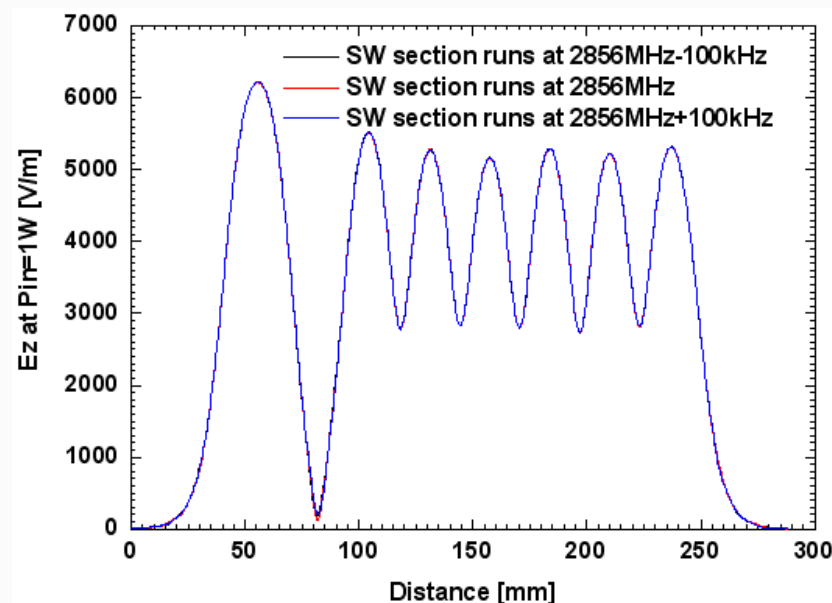
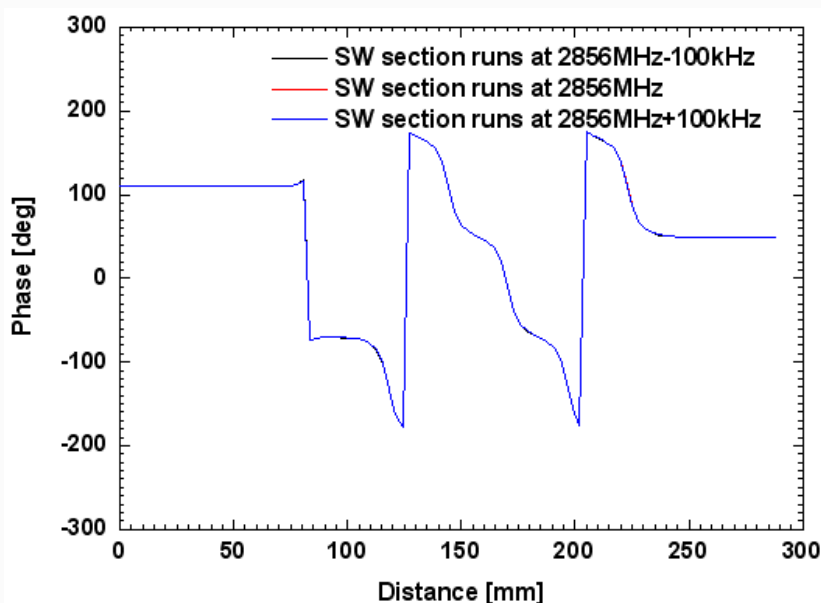

- Both the RF phase and field amplitude are not sensitive to the resonate frequency of the SW section, this is different from the hybrid photo-injector.
- $<0.5^\circ$ phase change is found when the SW section has an off-resonance of 100kHz. For temperature control of $\pm 0.1^\circ\text{C}$ ($\pm 5\text{kHz}$ off-resonance), the corresponding phase variation caused by the frequency off-resonance of the SW section is $\sim \pm 0.025^\circ$, which can be ignored.

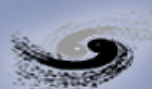

Key Points for 3D RF Design

- To obtain consistent results, the mesh size consistency in all of the RF structure design steps is the key.
- Attachment of the SW section with the TW section will increase the cavity resonate frequency of RF input coupler, therefore a modest bigger cavity size is needed.
- Based on the electron gun high voltage, the length of the coupling cavity in the SW section can be roughly calculated initially as the RF design baseline. Appropriate coupling cavity length is needed to place the electron beam at the positive slope of the RF field in the TW section to produce velocity bunching.
- For gun high voltage quite different from 120kV, the hybrid buncher structure need to be redesigned.



Summary

- For various reasons and different applications, the bunching system are usually simplified to lower the construction cost or complicated to enhance the beam performance (mainly bunching efficiency).
 - Industrial application: eliminate the PB and B but modify the first few cells of the standard accelerating section with gradually increasing ν_p (Performance↓)
 - Scientific application: introduce additional or replace the PB with one or more Sub-harmonic Bunchers (SHB). (Cost↑)
- To simplify the standard bunching system but with slightly degraded beam performance and relatively lower construction cost, One bunching system with HB used to replace the PB and B was designed, which can still meet the design requirement.
- Besides the integration of the PB and B, the standard accelerating section can also be integrated with the HB, which can further simplify the bunching system and lower the construction cost.

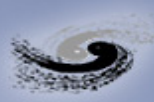

Thanks for your attention!



IPAC  **13**

The 4th International Particle Accelerator Conference
第四屆國際粒子加速器會議

Shanghai China
12-17 May 2013
Shanghai International Convention Center

