

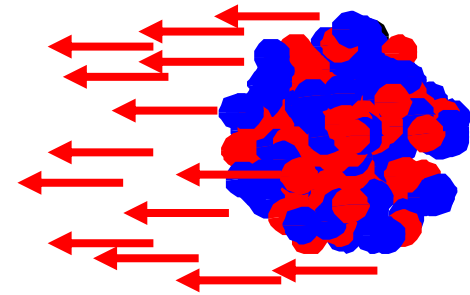

p



# Proton-Nucleus Collisions in the LHC

J. M. Jowett, R. Alemany-Fernandez, P. Baudrenghien, D. Jacquet,  
M. Lamont, D. Manglunki, S. Redaelli, M. Sapinski, M. Schaumann,  
M. Solfaroli Camillocci, R. Tomás, J. Uythoven, D. Valuch,  
R. Versteegen, J. Wenninger

CERN, Geneva, Switzerland

*With thanks for their contributions to many other colleagues  
in the CERN Accelerator and Technology Sector*

# Abstract

Following the high integrated luminosity accumulated in the first two Pb-Pb collision runs in 2010 and 2011, the LHC heavy-ion physics community requested a first run with p-Pb collisions.

This **almost unprecedented mode of collider operation** was not foreseen in the baseline design of the LHC whose two-in-one magnet design imposed equal rigidity and, hence, **unequal revolution frequencies, during injection and ramp.**

Nevertheless, after a successful **pilot physics fill** in 2012, the LHC provided  **$31 \text{ nb}^{-1}$  of p-Pb luminosity** per experiment, at an energy of **5.02 TeV per colliding nucleon pair**, with **several variations of the operating conditions**, in early 2013. Together with a companion p-p run at 2.76 TeV, this was the last physics before the present long shutdown.

We summarise the beam physics, operational adaptations and strategy that resulted in extremely rapid commissioning.

Finally, we give an account of the progress of the run and provide an analysis of the performance.

# RF Frequency for p and Pb in LHC

$$f_{\text{RF}} = \frac{h_{\text{RF}}}{T(p_p, m, Q)} \quad , \quad T(p_p, m, Q) = \frac{c}{v} \sqrt{1 + \left(\frac{mc}{Qp_p}\right)^2} (1 + \eta\delta), \quad h_{\text{RF}} = 35640 \quad \text{in LHC}$$

LHC has independent RF systems in each ring.

Equal  $f_{\text{RF}}$  at injection

⇒ ±35 mm orbit displacement in arcs

Must ramp with unequal  $f_{\text{RF}}$

⇒ long-range beam-beam encounters are moving

⇒ kicks vary from turn-to-turn

⇒ modulated beam-beam kicks

⇒ possible instability, emittance growth

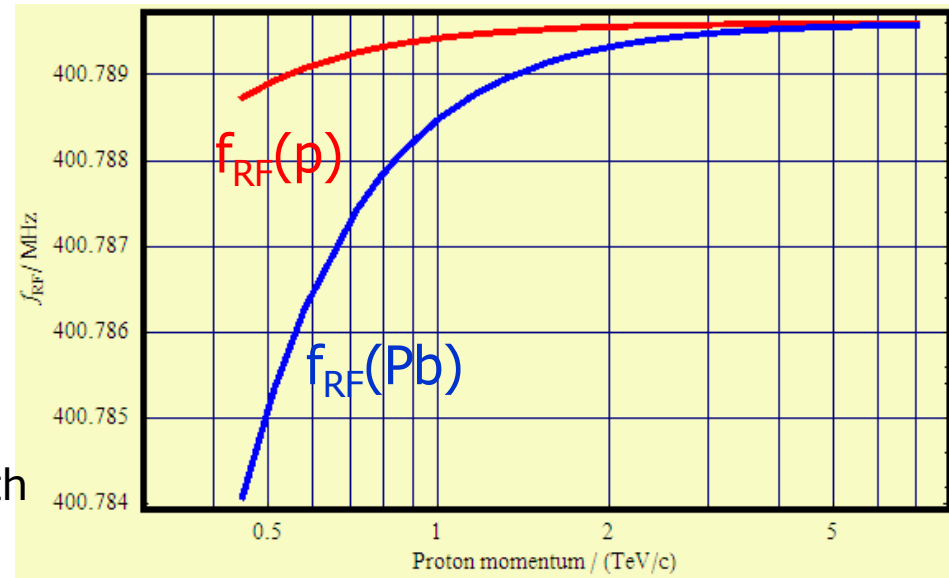

At top energy, 4Z TeV in 2012-13, it is possible to equalise revolution frequencies with equal and opposite ±0.3 mm displacements of the proton and lead beams. Can only do this after ramp.

# RHIC D-Au in 2003 (PAC'2003, TPPB043)

- Initial attempts with equal rigidity, unequal frequencies as in LHC
  - “modulated long-range beam-beam forces created untunable beam loss”
  - Doubts of feasibility for LHC; not part of LHC TDR

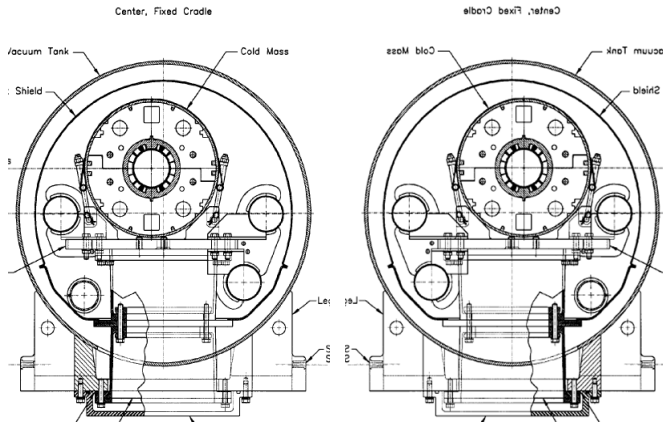

RHIC: Independent bending field for the two beams – switched to equal-frequency injection and ramp for successful D-Au operation.

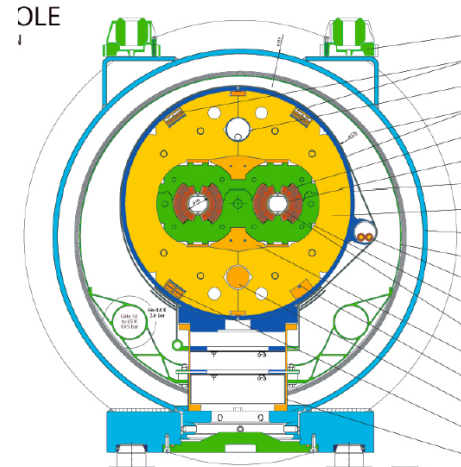

LHC: Identical bend field in both apertures of two-in-one dipole – no choice!

# History and preparations for p-Pb physics

- ❑ 2005 CERN workshop on pA in LHC
  - Predicted that p-Pb in LHC could work
  - Detailed physics case written up
- ❑ 2010-11 first two Pb-Pb runs of LHC make  $10 \mu\text{b}^{-1} + >150 \mu\text{b}^{-1}$ 
  - Urgent need for p-Pb comparison data ( $30 \text{ nb}^{-1}$ )
  - Request from ALICE considered, early 2011
- ❑ Detailed review and adaptation of all LHC systems, machine protection, operational procedures
- ❑ Feasibility test 31 October 2011
- ❑ Go-ahead for further tests and pilot run in 2012
  - But all machine study time in 2012 lost for various reasons ...

First asymmetric collisions at LHC

# **2012 PROTON-LEAD PILOT RUN**

# Concept

- ❑ Take LHC through the new operational sequence for physics for the first time
- ❑ Provide experiments with first useful physics data to set up their triggers in advance of production run a few months later
- ❑ Beam parameters (no squeeze, few bunches) chosen to allow shortest possible set-up and yet satisfy machine protection requirements in the course of a typical LHC machine study period (16 h allocated)

# Pilot p-Pb run, night of 13-14 September 2012

- ❑ **16:00** Starting injection, problems with ions, timing events not sent out correctly.
- ❑ 18:30 Filling Pb ions, first time in 2012
- ❑ 19:00 Start of ramp. Lost the beam on TCT position interlocks, revert collimator settings and try again ....
- ❑ QPS problems. RF problems.
- ❑ **22:52 15 p and 15 Pb bunches at 4 Z TeV, 8 colliding per experiment, 3 sacrificial for collimation setup**
- ❑ 23:35 Beams in collision, unsqueezed, optimising ...
- ❑ 00:50 Start of loss maps to set up collimation
- ❑ **01:26 Stable beams for p-Pb Physics**
- ❑ 06:04 Adjust mode to move IP for ALICE
- ❑ 06:25 Stable beams again, IP moved by -0.5 m
- ❑ 07:55 Stable beams again, IP moved by +0.5 m
- ❑ 09:35 Beams dumped by operators



# Predictions for p-Pb performance in pilot fill

Main choice:	Units	Single	13b	8	8	8.txt
Beam energy/( Z TeV)	ZTeV					4
Colliding bunches						8
$\beta^*$	m					10/11
Emittance protons	$\mu\text{m}$					1.5
Emittance Pb	$\mu\text{m}$					1.5
<b>Pb/bunch</b>	$10^8$					1.2
p/bunch	$10^{10}$					1.15
RMS Beam size (Pb)	$\mu\text{m}$					<b><math>\sim 94</math></b>
Bunch length	cm					$\sim 7$
<b>Initial Luminosity <math>L_0</math></b>	<b><math>10^{25} \text{ cm}^{-2} \text{ s}^{-1}</math></b>					<b>1-10 (max)</b>

The maximum luminosity was achieved.

Integrated luminosity of  $1 \mu\text{b}^{-1}$  from one fill.

# Collisions in all experiments

ALICE

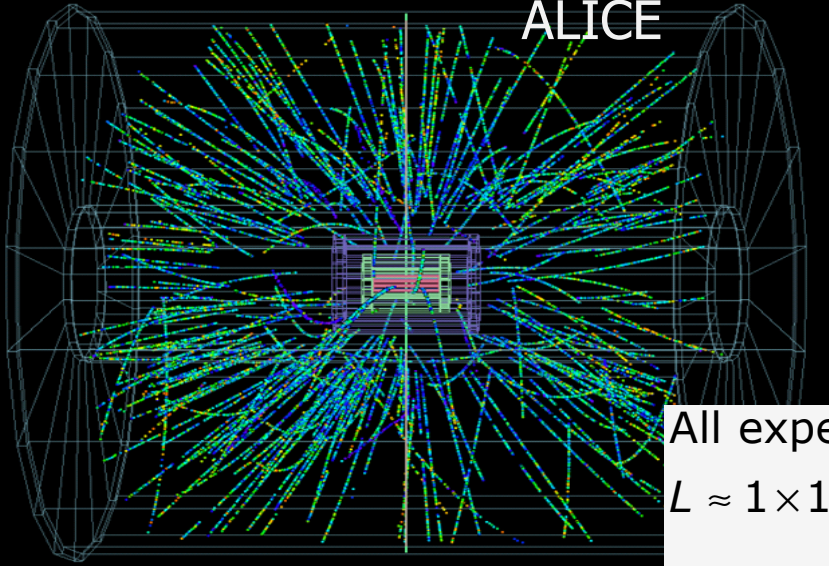

ATLAS

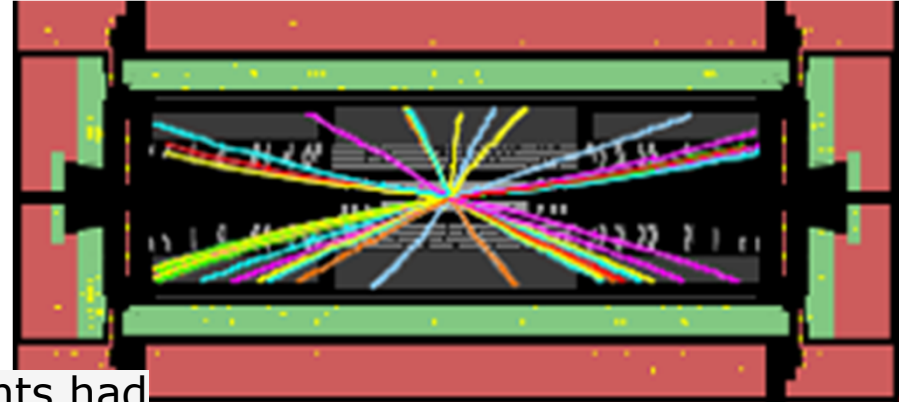

All experiments had  
 $L \approx 1 \times 10^{26} \text{ cm}^{-2} \text{ s}^{-1}$

LHCb I

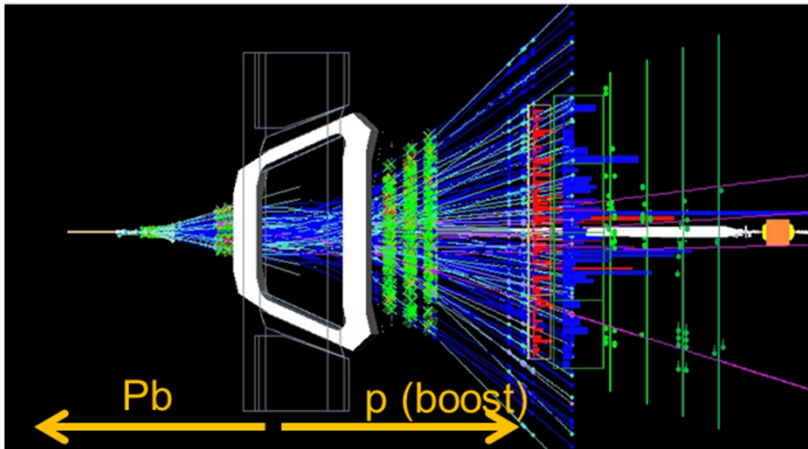

CMS

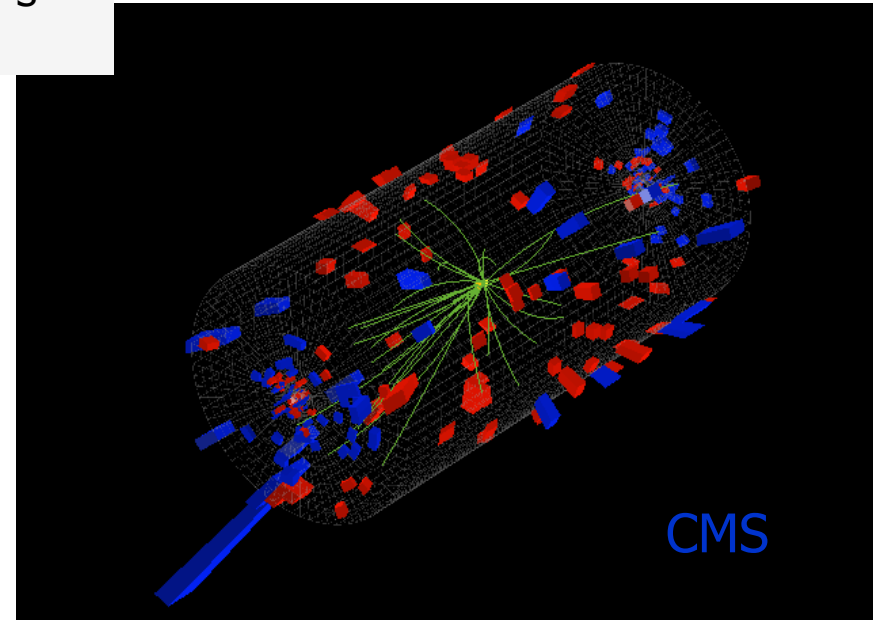

# Correlations in p-Pb: the unexpected "ridge"



ALICE

- A double-ridge structure appears, with remarkable properties:
  - Can be expressed in terms of  $v_{2,3}$ , Fourier coefficients of single particle azimuthal distribution, with  $V_{2,3}$  increasing with  $p_T$  and  $v_2$  also with multiplicity
  - **Same yield near and away side for all classes of  $p_T$  and multiplicity: suggest common underlying process**
  - Width independent of yield
  - No suppression of away side observed (its observation at similar x-values at RHIC is considered a sign of saturation effects)
  - In agreement with viscous hydro calculations ?!

## Low multiplicity event class High multiplicity event class

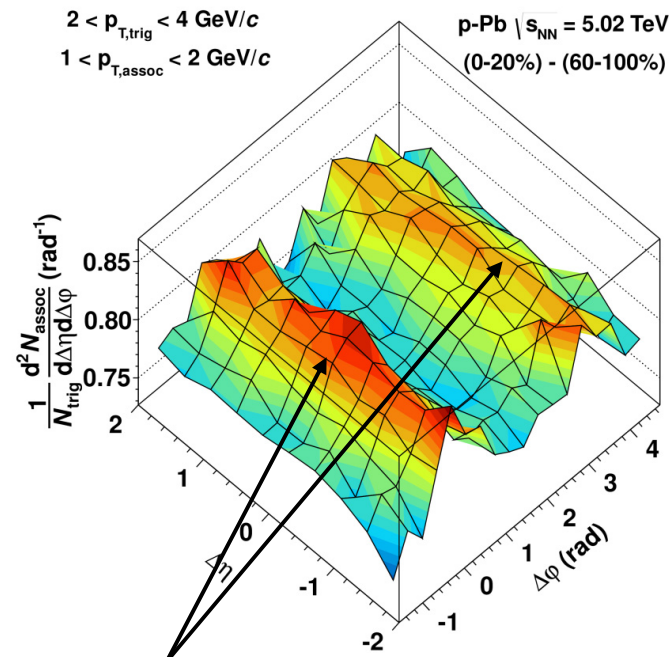
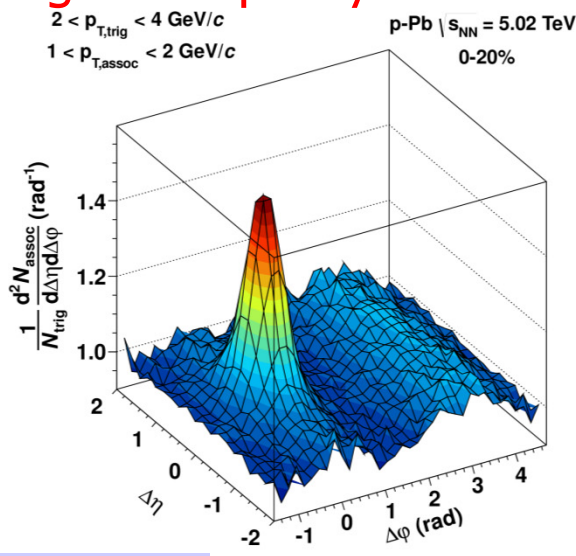
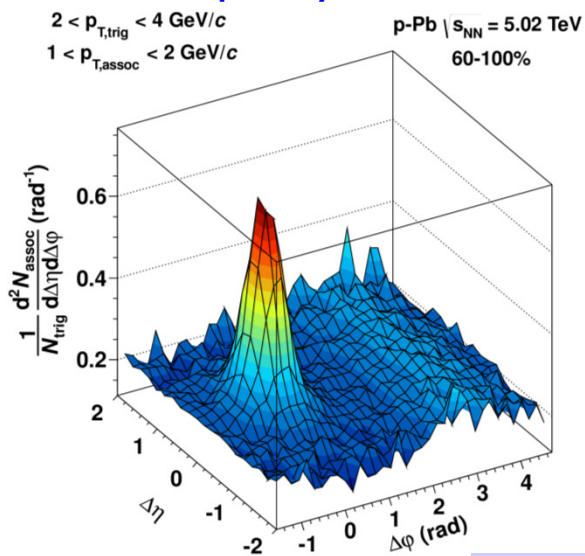

P. Giubellino,  
Evian Dec 2012

**Double-ridge structure**

# Correlations in p-Pb: the unexpected "ridge"



CE

- A double-ridge structure appears, with remarkable properties:
  - Can be expressed in terms of  $v_{2,3}$ , Fourier coefficients of single particle azimuthal distribution, with  $V_{2,3}$  increasing with  $p_T$  and  $v_2$  also with multiplicity
  - **Same yield near and away side for all classes of  $p_T$  and multiplicity suggest common underlying process**
  - Width independent of yield
  - No suppression of away side observed (its observation is considered a sign of saturation effects)
  - In agreement with viscous hydro calculations ?

Low multiplicity event class High multiplicity

$2 < p_{T, \text{trig}} < 4 \text{ GeV}/c$   
 $1 < p_{T, \text{assoc}} < 2 \text{ GeV}/c$

p-Pb |  $s_{NN} = 5.02 \text{ TeV}$   
 60-100%

$2 < p_{T, \text{trig}} < 4 \text{ GeV}/c$   
 $1 < p_{T, \text{assoc}} < 2 \text{ GeV}/c$

$2 < p_{T, \text{trig}} < 4 \text{ GeV}/c$   
 $1 < p_{T, \text{assoc}} < 2 \text{ GeV}/c$

$2 < p_{T, \text{trig}} < 4 \text{ GeV}/c$   
 $1 < p_{T, \text{assoc}} < 2 \text{ GeV}/c$

p-Pb |  $s_{NN} = 5.02 \text{ TeV}$   
 (0-20%) - (60-100%)

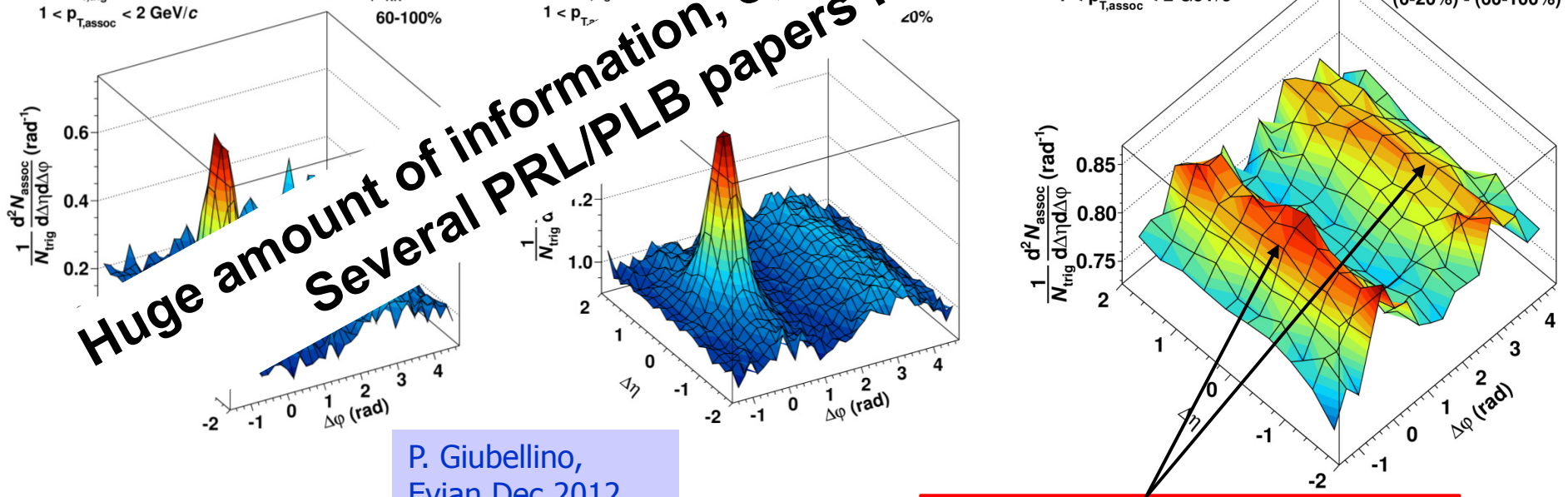

Huge amount of information, opening a new window in the field  
Several PRL/PLB papers from 4 h of collisions

P. Giubellino,  
 Evian Dec 2012

**Double-ridge structure**

# Correlations in p-Pb: the unexpected "ridge"



CE

Opening a new window in the field of heavy ion collisions

- A double-ridge structure appears, with remarkable properties:
  - Can be expressed in terms of  $v_{2,3}$ , Fourier coefficients of single particle azimuthal distribution, with  $V_{2,3}$  increasing with  $p_T$  and  $v_2$  also with multiplicity
  - **Same yield near and away side for all classes of  $p_T$  and multiplicity suggest common underlying process**
  - Width independent of yield
  - No suppression of away side observed (its observation is considered a sign of saturation effects)
  - In agreement with viscous hydro calculations ?

Low multiplicity event

$2 < p_{T, \text{trig}} < 4 \text{ GeV}/c$   
 $1 < p_{T, \text{assoc}} < 2 \text{ GeV}/c$   
 p-Pb |  $s_{NN} = 5.02 \text{ TeV}$   
 (0-20%) - (60-100%)

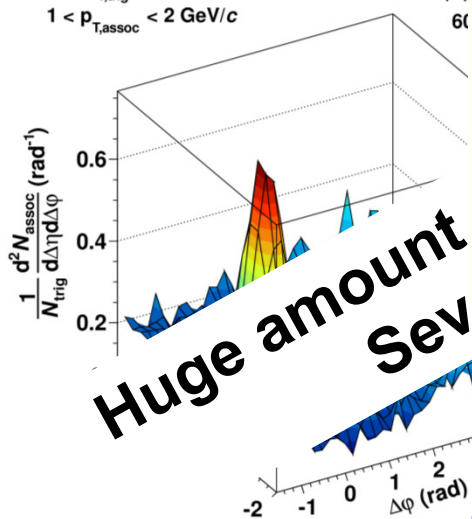

Similar results published by CMS (first) and ATLAS, physics papers still coming from this first pilot fill.

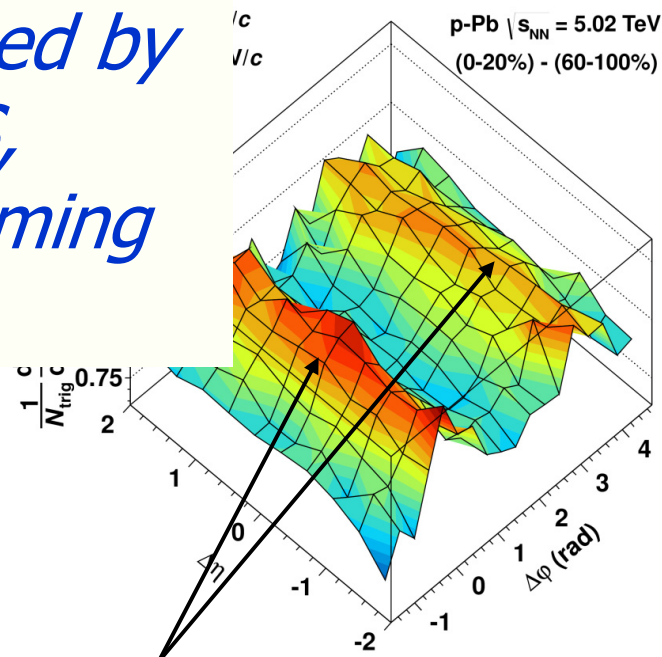
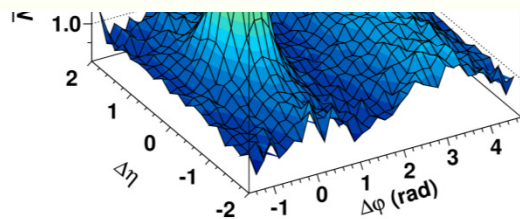

P. Giubellino, Evian Dec 2012

**Double-ridge structure**

First asymmetric collisions at LHC

**2013 PROTON-LEAD RUN**

# Physics requests for the 2013 p-Pb run

- Initial minimum bias p-Pb for ALICE

$$\left. \begin{array}{l} L_{\text{ALICE}} < 0.05 \times 10^{29} \text{ cm}^{-2}\text{s}^{-1} \\ \mu_{\text{ALICE}} < 0.003 \end{array} \right\} \text{ at } \sqrt{s_{\text{NN}}} = 5.02 \text{ TeV (4Z TeV/beam)}$$

- Integrate  $30 \text{ nb}^{-1}$  in ALICE respecting the constraints:

$$\begin{array}{l} L_{\text{ALICE}} < 1. \times 10^{29} \text{ cm}^{-2}\text{s}^{-1} \\ \mu_{\text{ALICE}} < 0.05 \end{array} \quad \sim 30000 \text{ pilot runs}$$

- Similar (or more) luminosity in ATLAS and CMS
- Beam reversal p-Pb to Pb-p for ALICE, LHCb
- 2 ALICE polarity reversals (also LHCb)
- Few  $\text{nb}^{-1}$  in LHCb (new to heavy-ion operation)
- Van der Meer (luminosity) scans
  
- 2<sup>nd</sup> priority: intermediate energy p-p operation
  - $\sqrt{s_{\text{NN}}} = 2.76 \text{ TeV (1.38 TeV/beam)}$ 
    - Integrate  $5 \text{ nb}^{-1}$  in ATLAS, CMS
- 3<sup>rd</sup> priority: p-Pb with injection optics for LHCf
  - About 1 day required to commission and run

## 2013 LHC & Injector Schedule

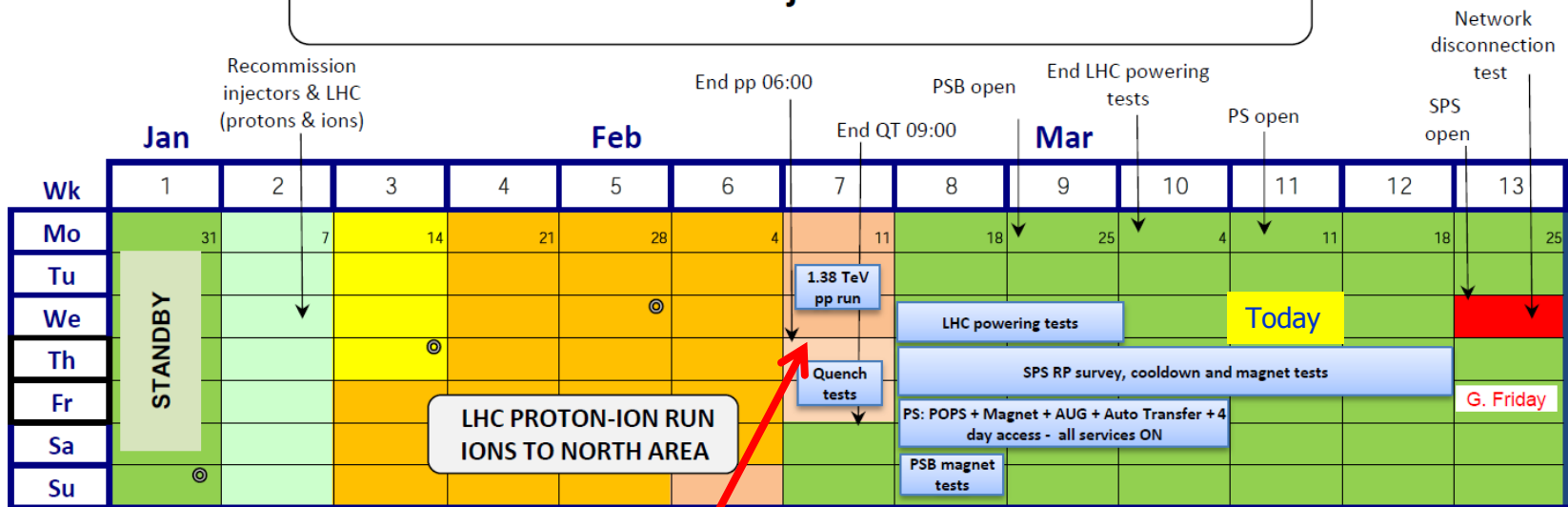

2013 run was finally extended by 2 days to allow time to reach integrated luminosity goals for both p-Pb and intermediate energy p-p.



# Commissioning p-Pb operation, January 2013

- ❑ Still no test of unequal frequency injection ramp with required intensity ... factor 1000 in luminosity to gain over pilot run
- ❑ From ~cold start after end-of-year stop
  - Pb pre-injectors kept running
  - → **D. Manglunki et al, WEPEA061, Wed**  
(remarkable performance of Pb injectors later!)
- ❑ Detailed plan of essential stages, adapted in real time
  - Decided to re-make optics squeeze from scratch (new low values in ALICE, LHCb)
  - Off-momentum collisions, many new features
  - New collimation set-up
  - → **R. Versteegen et al, TUPFI041, Tue**
- ❑ Unprecedented new operation mode of LHC commissioned in < 10 days (including ~4 days down-time for power, cryo)
  - Quality of LHC hardware, systems, operation

# The Moment of Truth, finally, 20/1/2013

Fill 3474

First injection and ramp of Pb trains against proton trains

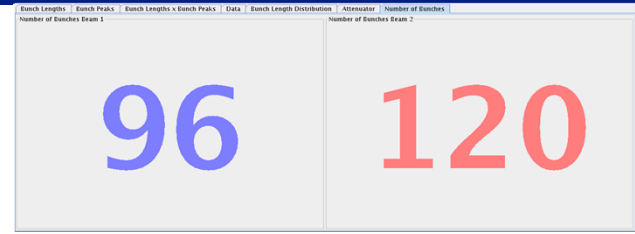

(the MD we've been trying to do since 10 September 2012).

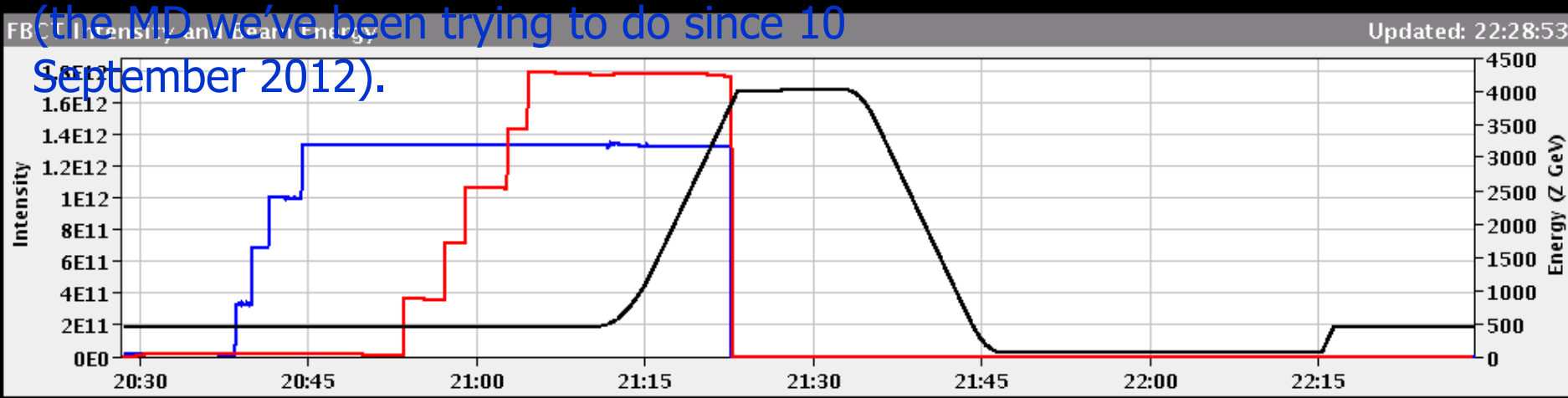

Moving long-range beam-beam encounters do not cause significant beam losses or emittance blow-up with LHC parameters

# Full filling scheme 21/1/2013

LHC Page1

Fill: 3479

E: 4000 Z GeV

21-01-13 08:16:31

## PROTON-NUCLEUS PHYSICS: FLAT TOP

Energy:

4000 Z GeV

I(B1):

1.67e+09

I(B2):

4.35e+08

FBCT Intensity and Beam Energy

Updated: 08:16:31

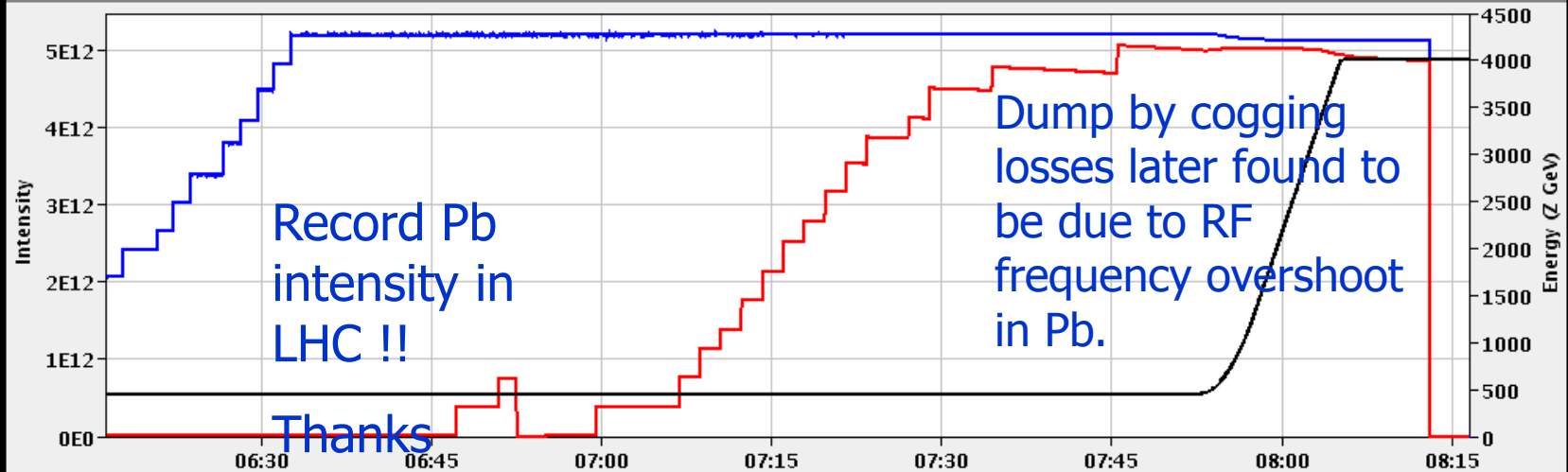

Comments (21-Jan-2013 07:25:03)

Fill for physics with 338 bunches

(R1: p+, R2: Pb)

BIS status and SMP flags

B1

B2

Link Status of Beam Permits

true

true

Global Beam Permit

false

false

Setup Beam

false

false

Beam Presence

false

false

Moveable Devices Allowed In

false

false

Stable Beams

false

false

AFS: 200ns\_338p\_338Pb\_15inj24bpi

PM Status B1

ENABLED

PM Status B2

ENABLED

# During commissioning

Pb-p Intensity ramping was delayed by several dumps caused by losses at the start of cogging, when the two beams are brought to the same frequency

Losses were reduced by making a slower frequency trim (3 steps of 10 Hz max, and 10 s waiting time in between)

- The BLM beam dump threshold was increased in selected BLMs. This was also needed to cope with losses in squeeze and start of ramp
- All problems were in the Pb ring, probably linked to the lower collimation efficiency
- Ring 2 was somewhat less "touchy".  
p-Pb caused fewer problems than Pb-p

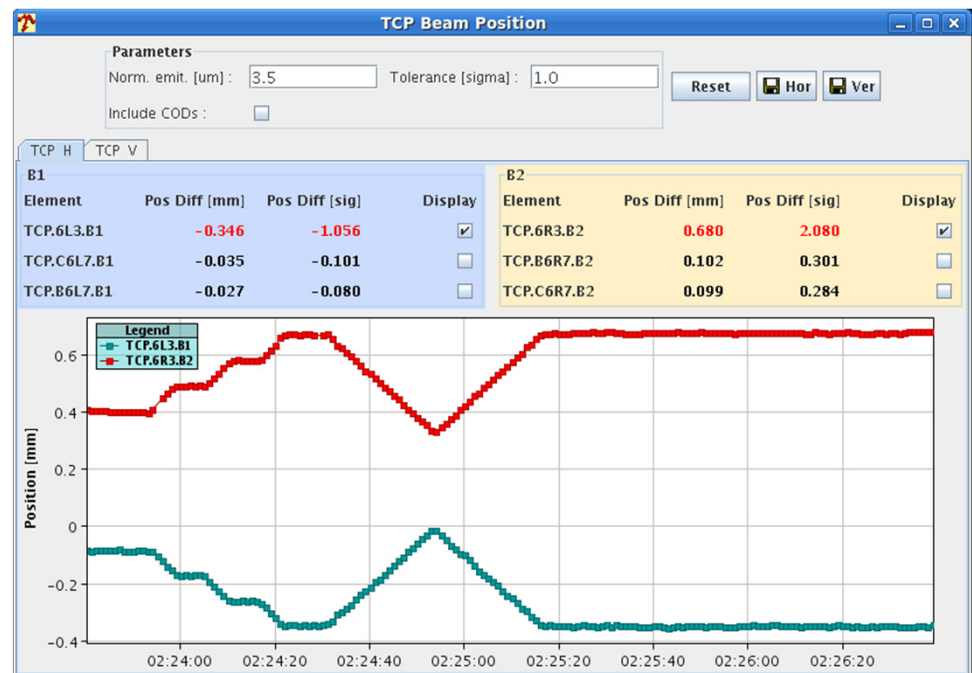

Horizontal position B1 and B2. Visible are the three steps (~ 10 Hz each) with the 10 s waiting. The following triangle brings the intersection point (IP) in the exact center of the detectors. To achieve this, the beams are briefly brought back to the center orbit.

# RF "cogging" during and after energy ramp

We monitor the time interval between the revolution frequency markers (bucket 1 of both rings)

Cogging takes 15 minutes maximum

Fully automatic. The references were calibrated at the beginning of the run and not touched during the four weeks

Ramping

IP close to desired position, we move the beams to the common frequency

One last orbit bump to get IP exact

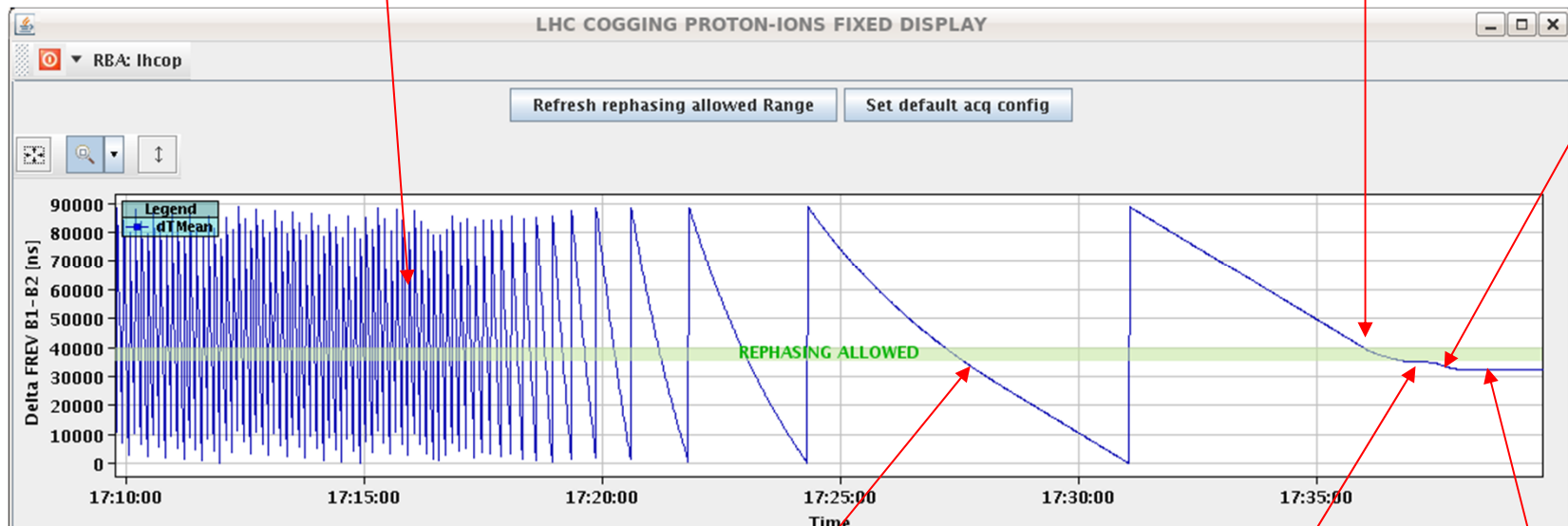

Start flat top but the IP is very far from the desired collision point. We move the beams onto the central orbits. With 60 Hz difference, IP makes one turn in 11 minutes

Same frequency but IP not exact

Done!

# Run overview: p-Pb luminosity production

Timeseries Chart between 2013-01-20 03:49:00.000 and 2013-02-02 12:00:30.000 (LOCAL\_TIME)

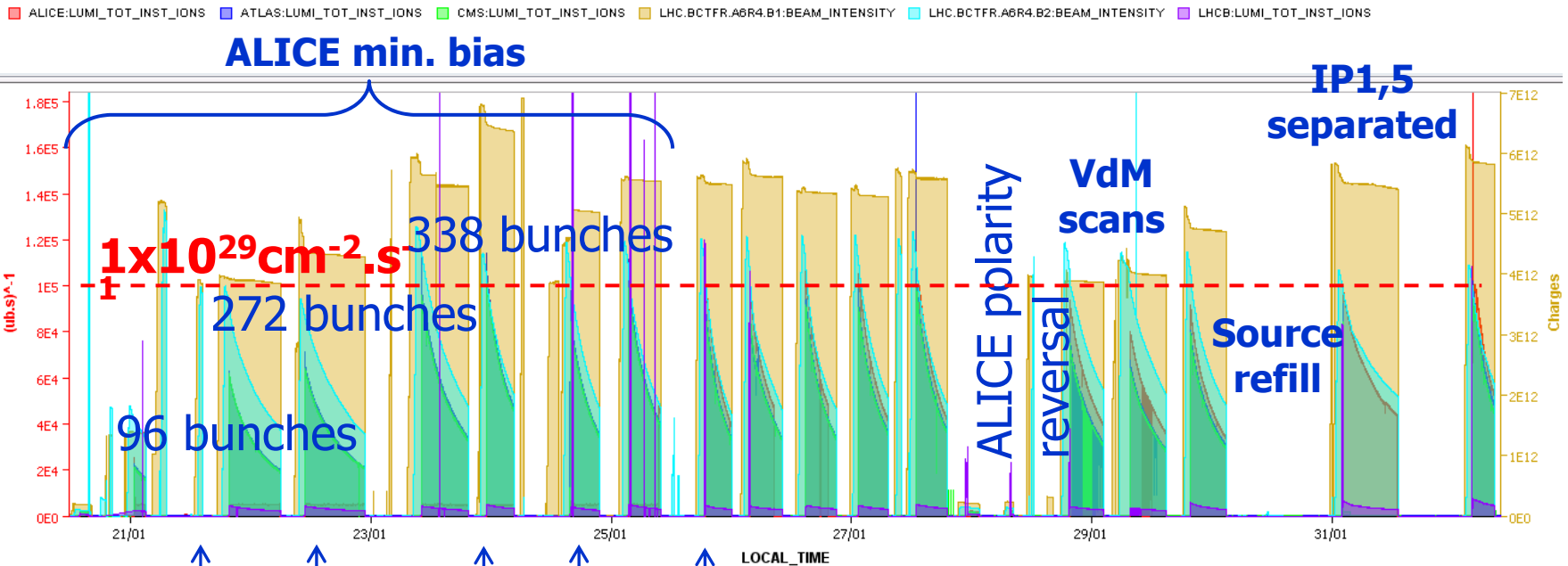

Increase of BLM monitor factor (losses during cogging)

Problem of losses during cogging solved

TOTEM Roman Pots moved in

ALFA Roman Pots moved in

Longitudinal blow up ON

# Run overview: Pb-p luminosity production

Timeseries Chart between 2013-02-02 03:49:00.000 and 2013-02-10 09:36:53.103 (LOCAL\_TIME)

ALICE:LUMI\_TOT\_INST\_IONS ATLAS:LUMI\_TOT\_INST\_IONS CMS:LUMI\_TOT\_INST\_IONS LHC.BCTFR.A6R4.B1:BEAM\_INTENSITY LHC.BCTFR.A6R4.B2:BEAM\_INTENSITY LHC.BCTFR.A6R4.B3:BEAM\_INTENSITY

Max. peak luminosity  $1.15 \times 10^{29} \text{cm}^{-2} \cdot \text{s}^{-1}$ !

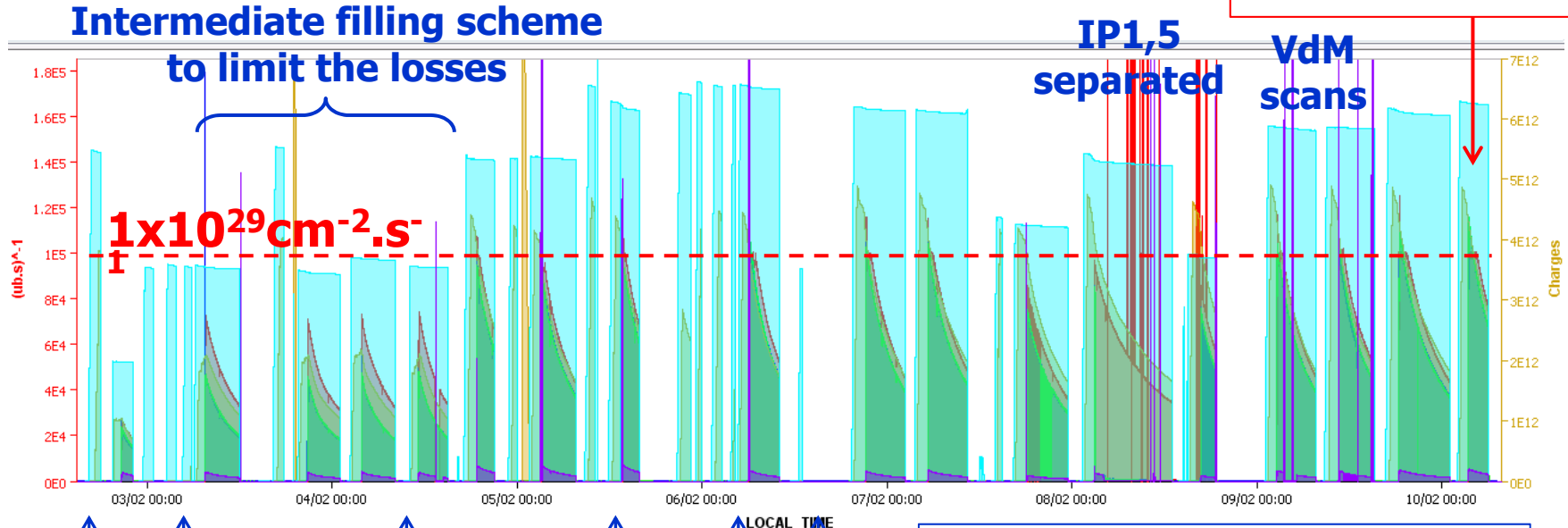

Increase of BLM monitor factor (losses end of ramp + squeeze)

Increase bandwidth of orbit feedback

Increase of BLM monitor factor (losses at the start of the ramp), rematch injection energy to the SPS

Common frequency trimmed by -10Hz

Increase of BLM monitor factor (losses during the squeeze),

reduction of longitudinal blow-up at injection

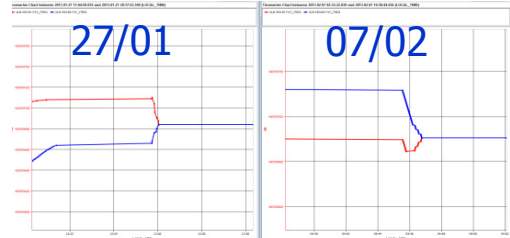

RF frequencies

# Peak and integrated luminosity evolution

Peak Luminosity during p-Pb run in 2013

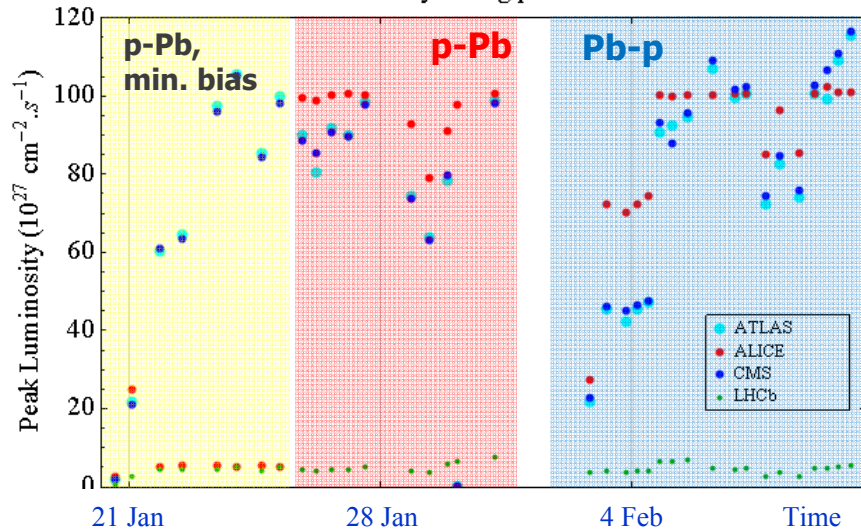

Integrated Luminosity over p-Pb run in 2013

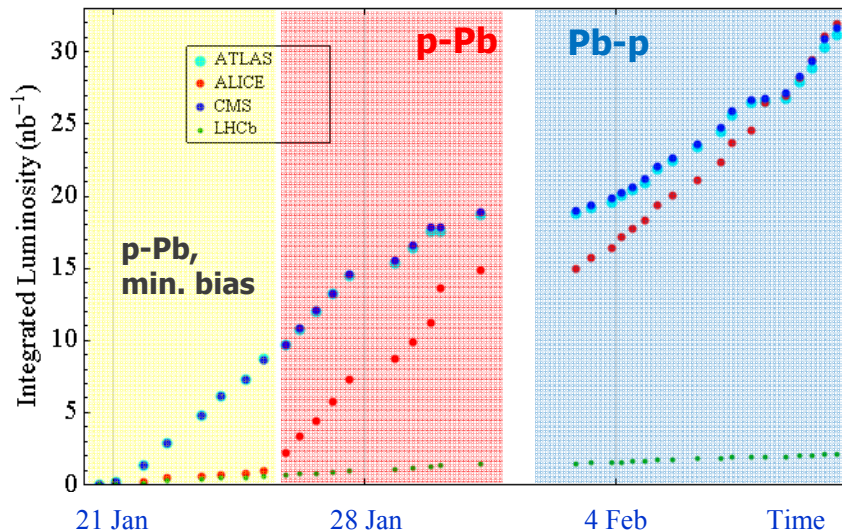

- Full instantaneous luminosity  $1 \times 10^{29} \text{ cm}^{-2} \cdot \text{s}^{-1}$  already reached with the first fill with full filling scheme
- Levelling in ALICE at  $1 \times 10^{29} \text{ cm}^{-2} \cdot \text{s}^{-1}$  in almost all standard fills
- Two catch-up fills done with IP1 and 5 separated, allowing ALICE to catch up after initial minimum-bias
- Van der Meer scans done in both configurations
- Final integrated luminosity above experiments' request of  $30 \text{ nb}^{-1}$
- The run ended with record peak luminosity of  $1.15 \times 10^{29} \text{ cm}^{-2} \cdot \text{s}^{-1}$ , record turn around of 2.37 h

ALICE:  $31.94 \text{ nb}^{-1}$

ATLAS:  $31.2 \text{ nb}^{-1}$

CMS:  $31.69 \text{ nb}^{-1}$

LHCb:  $2.12 \text{ nb}^{-1}$



# Luminosity evolution during a fill

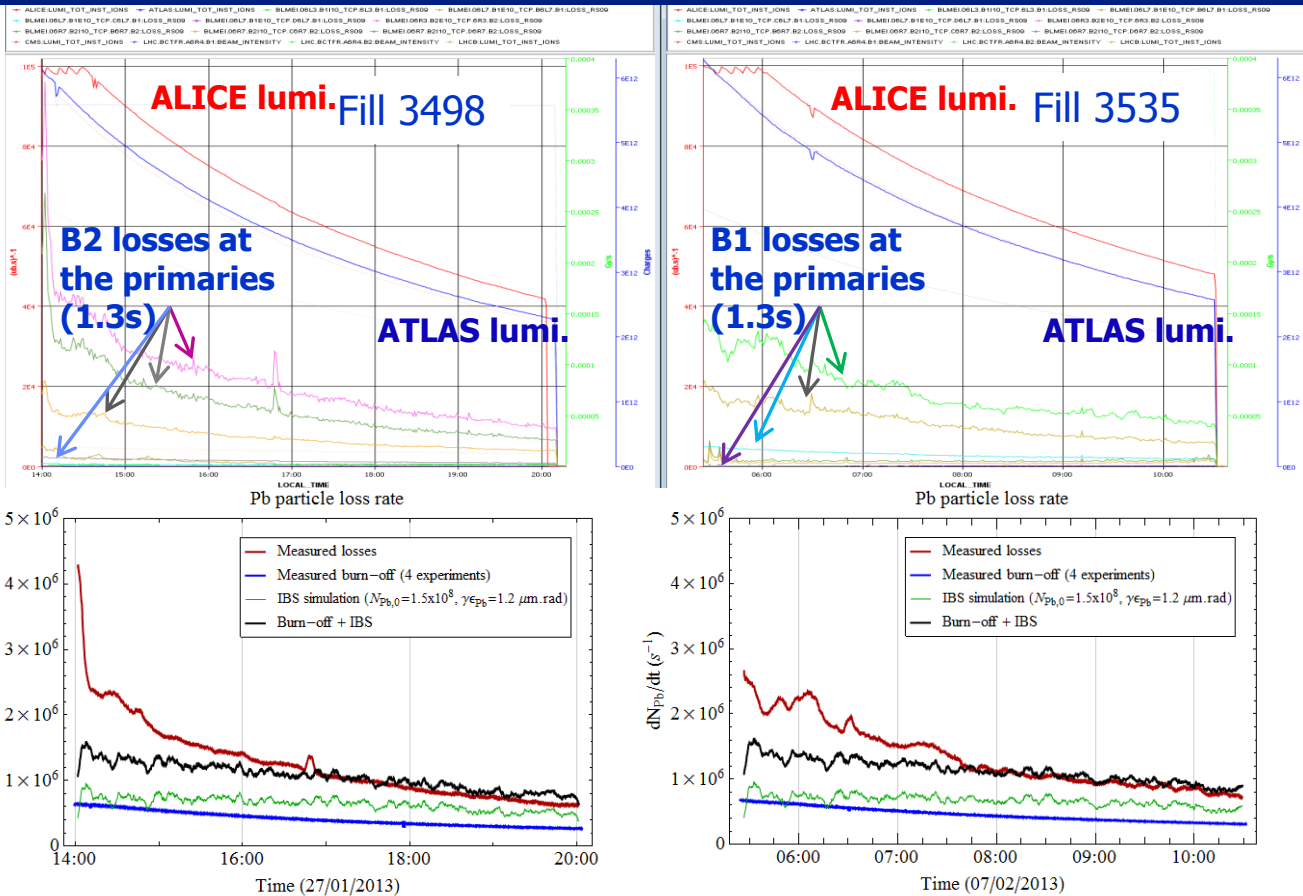

- Luminosity evolution was driven by Pb intensity decay.
- Sources of losses were mainly luminosity burn-off and intra-beam scattering (IBS), possibly also beam-beam (unequal beam sizes in collision)
- Additional losses at start of stable beams are comparable to Pb beam BLM signals, likely due to tight collimator settings.

# Pb intensity evolution, fill duration

Total number of charges in Pb beam (start of Stable Beams)

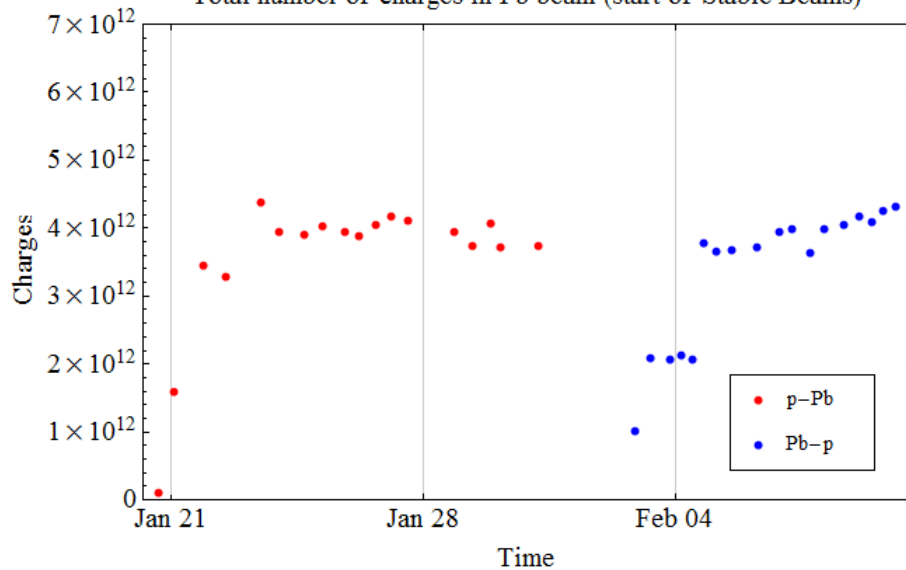

Duration of Stable Beams during p-Pb run in 2013

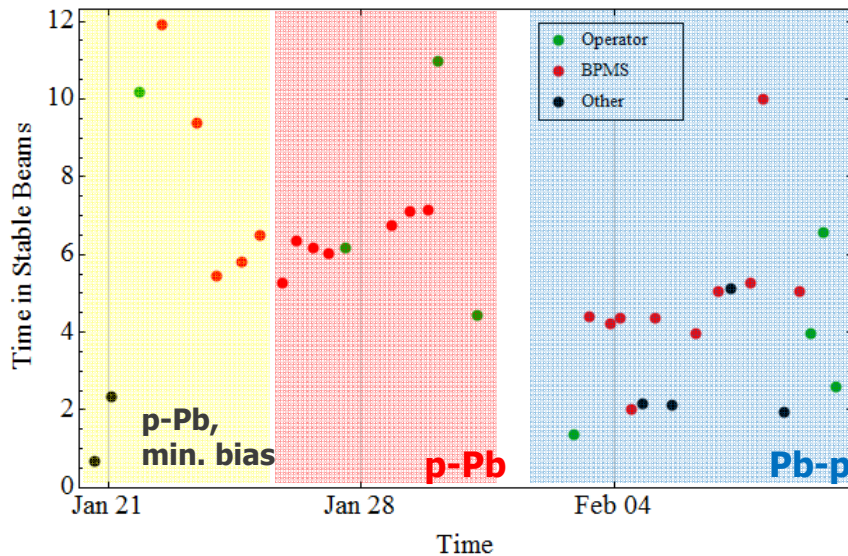

- Injectors provided **very good quality Pb beams**: average number of ions per bunch was  $1.44 \times 10^8$  at start of stable beams (mean over the run), i.e. almost **twice the nominal intensity**,
- Most fills were dumped by the **BPMs thresholds in IR6** due to misreading for lowest intensity Pb bunches
- BPMs' limit was reached faster with B1 (Pb-p) than with B2 (p-Pb),
- **Maximum fill durations of more than 10h** were reached with intermediate filling schemes and special fills colliding only in ALICE (and LHCb).

# Peak performance in p-Pb runs

	2012 pilot	2013 production
$E / (Z \text{ TeV})$	4	4
$k_c$	(8,8,8,8)	(296,288,296,39)
$\beta^*/m$	(11,10,11,10)	(0.8,0.8,0.8,2.0)
$\gamma\varepsilon(p) / \mu\text{m}$	1.7	2
$\gamma\varepsilon(\text{Pb}) / \mu\text{m}$	1.2	1.5
$N_{bp}$	$1.2 \times 10^{10}$	$1.6 \times 10^{10}$
$N_{b\text{Pb}}$	$7 \times 10^7$	$12 \times 10^7$
$L / (10^{29} \text{ cm}^{-2} \text{ s}^{-1})$	0.001	(1.12,1.01,1.16,0.05)

- Some numbers are averages because of the wide distribution of individual bunch parameters.
- Sets of four values correspond to the interaction points IP1(ATLAS), IP2(ALICE), IP5(CMS), IP8 (LHCb).

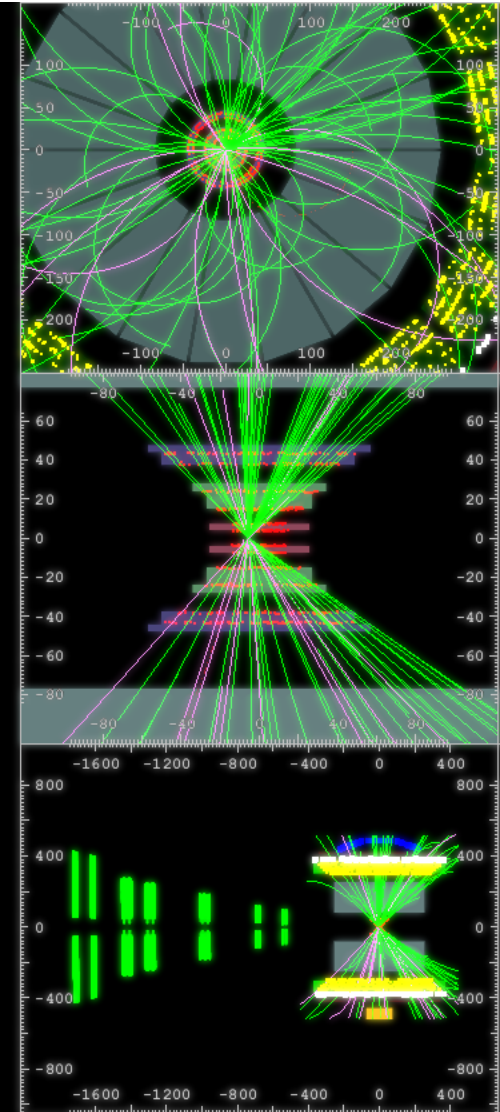
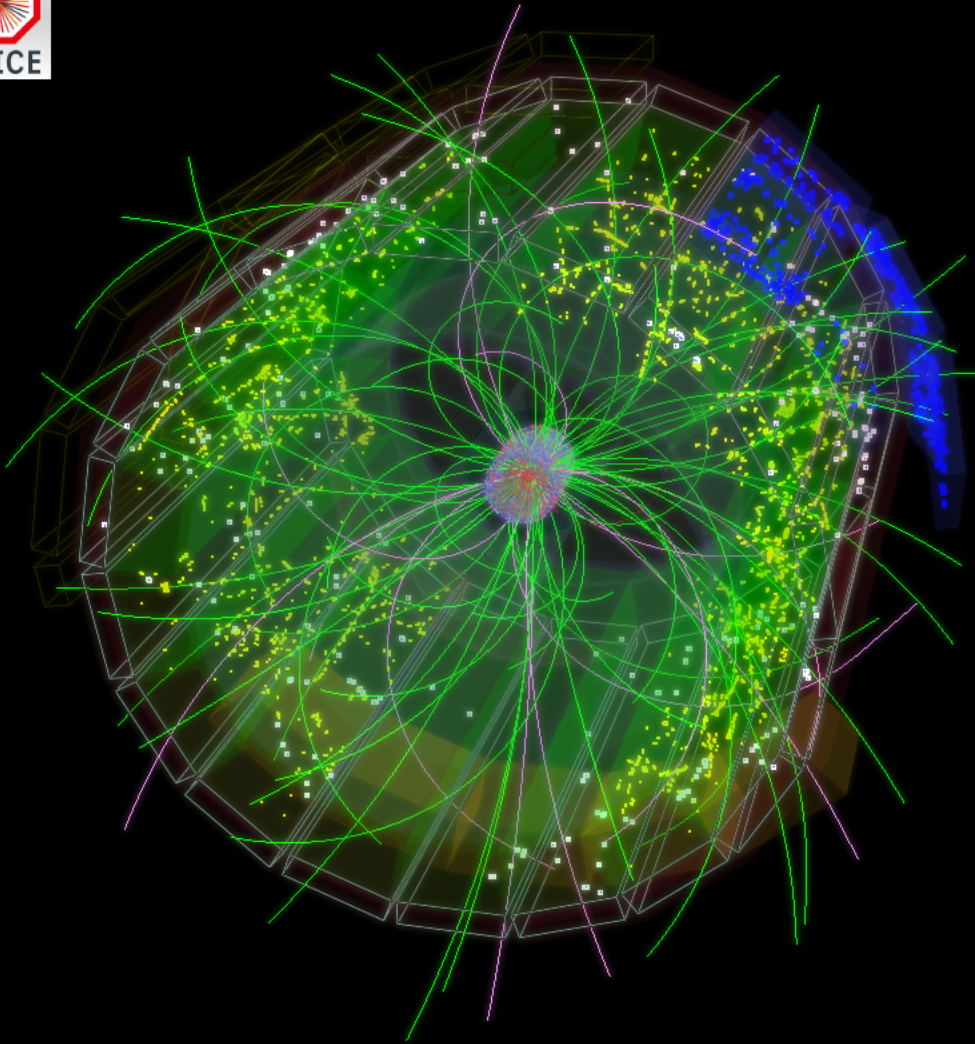



Photo: Michael Hoch / CERN

breaking

May 07, 2013

# Smallest lab-made drop of liquid might cause strange particle behavior

A new result from the CMS collaboration takes a step toward revealing the origin of the mysterious 'ridge effect.'

By Kelly Izlar



PDF Download

The Large Hadron Collider is known for a list of impressive facts—it's the world's largest and most powerful particle collider; it accelerates particles to nearly the speed of light; its cryogenic system keeps it colder than outer space.

Now it's under consideration for a new superlative: Scientists there might have created the most minuscule drop of liquid ever formed in a

Related symmetry content

## most popular

April 30, 2013

### Matter, antimatter, we all fall down—right?

Scientists perform the first direct investigation into how antimatter interacts with gravity.

May 7, 2013

### Smallest lab-made drop

First results from 2013 run now emerging:

Collective effects on a scale where they were not expected: viscous hydrodynamics of Quark-Gluon Plasma, gluon saturation (colour-glass condensate), ...?

May 11, 2013

This week's top tweet: Smallest lab-made drop of liquid might be

# Summary of first LHC p-Pb run

- ❑ A new mode of operation, unforeseen in the baseline design of the LHC, was commissioned in 10 days (including >4 days' down time).
- ❑ The physics requirements were fulfilled in both configurations p-Pb and Pb-p
- ❑ ALICE, ATLAS, CMS, LHCb, ALFA, TOTEM, LHCf all took data.
- ❑ Pb beam from injectors: very high quality, new intensity records.
- ❑ No serious beam-beam effects thanks to low proton beam intensity, allowing us to break a few rules (only way to give LHCb collisions).
- ❑ Proton beam intensity could not be increased because of bad readings on beam-dump interlock BPMs at their sensitivity limit.
- ❑ No clear effects of moving long-range beam-beam encounters at injection and ramp.
- ❑ Duration of fills given by strong luminosity burn-off and IBS.
- ❑ Beam loss monitor dump thresholds were pushed to theoretical quench limits, losses might have been reduced with more relaxed (=more open) collimator settings.
- ❑ Lack of emittance measurement capability during run
- ❑ Many other features not described here ...
- ❑ Prospect of about another order of magnitude in luminosity in future LHC runs at higher energy

# More about LHC p-Pb run

- ❑ R. Versteegen et al,
  - Operating the LHC Off-momentum for p-Pb Collisions
  - TUPFI041, Fire Poster Area, Tuesday
- ❑ D. Manglunki et al,
  - The First LHC p-Pb run: Performance of the Heavy Ion Production Complex
  - WEPEA061, Earth Poster Area, Wednesday
- ❑ Links to these, posters, other papers, talks, news items, videos, etc.

**<http://cern.ch/ipac2013-LHC-heavyion>**



# BACKUP SLIDES



# Momentum offset required through ramp

Minimise aperture needed by  $\delta_p = -\delta_{Pb} = \frac{c^2 \gamma_T^2}{4p_p^2} \left( \frac{m_{Pb}^2}{Z^2} - m_p^2 \right)$ .

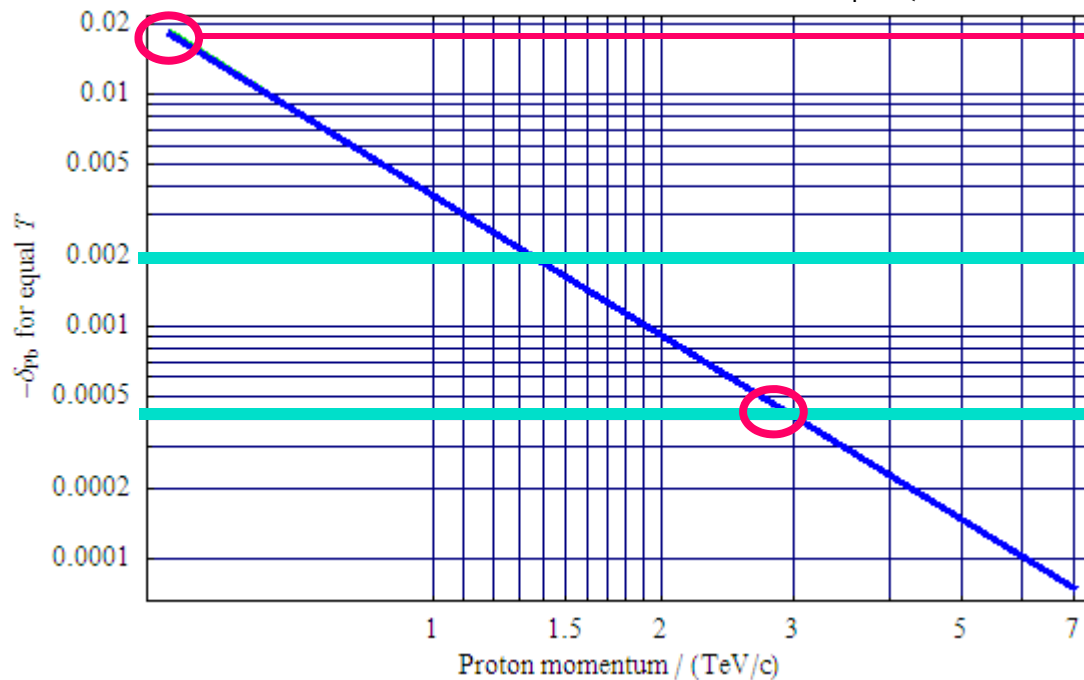

2% - would move beam by 35 mm in QF!!

Limit with pilot beams

Limit in normal operation (1 mm in arc QD)

Revolution frequencies must be equal for collisions at top energy.

Lower limit on beam energy for p-Pb collisions,  $E=2.7 Z$  TeV.

**RF frequencies must be unequal for injection, ramp!**

# Full filling scheme 21/1/2013

LHC Page1

Fill: 3479

E: 4000 Z GeV

21-01-13 08:16:31

## PROTON-NUCLEUS PHYSICS: FLAT TOP

Energy:

4000 Z GeV

I(B1):

1.67e+09

I(B2):

4.35e+08

FBCT Intensity and Beam Energy

Updated: 08:16:31

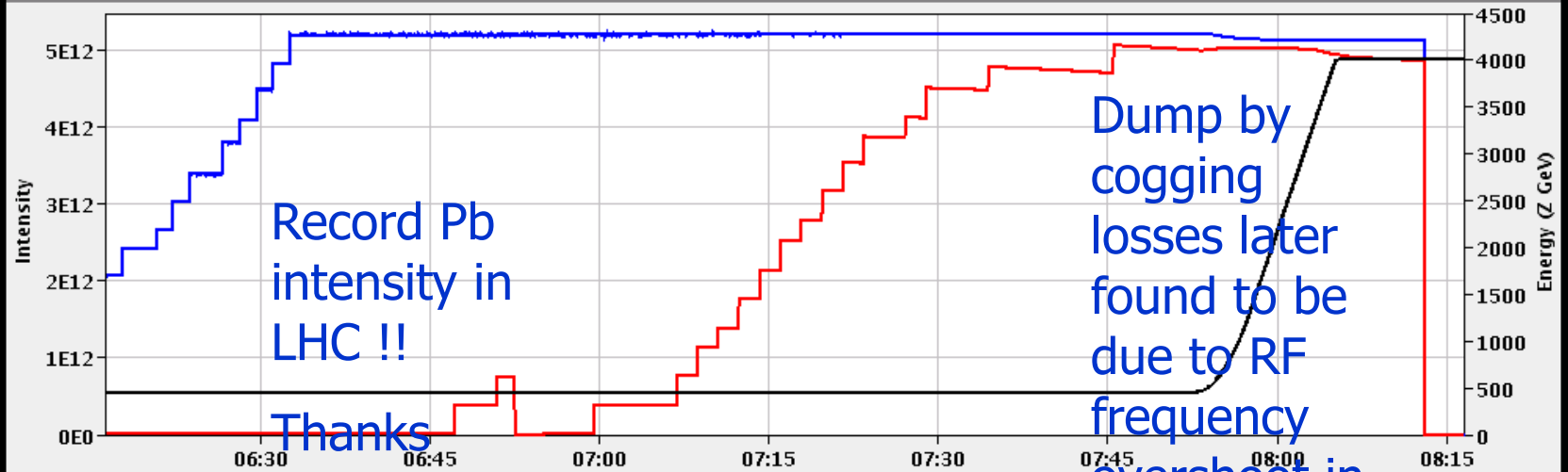

Record Pb intensity in LHC !!  
Thanks injectors!!

Dump by cogging losses later found to be due to RF frequency overshoot in Pb.

### BIS status and SMP flags

B1

B2

Comments (21-Jan-2013 07:25:03)

Fill for physics with 338 bunches

(R1: p+, R2: Pb)

Link Status of Beam Permits

true

true

Global Beam Permit

false

false

Setup Beam

false

false

Beam Presence

false

false

Moveable Devices Allowed In

false

false

Stable Beams

false

false

AFS: 200ns\_338p\_338Pb\_15inj24bpi

PM Status B1

ENABLED

PM Status B2

ENABLED

# Proton-lead run brings new physics reach to LHCb

*Antonella del Rosso*

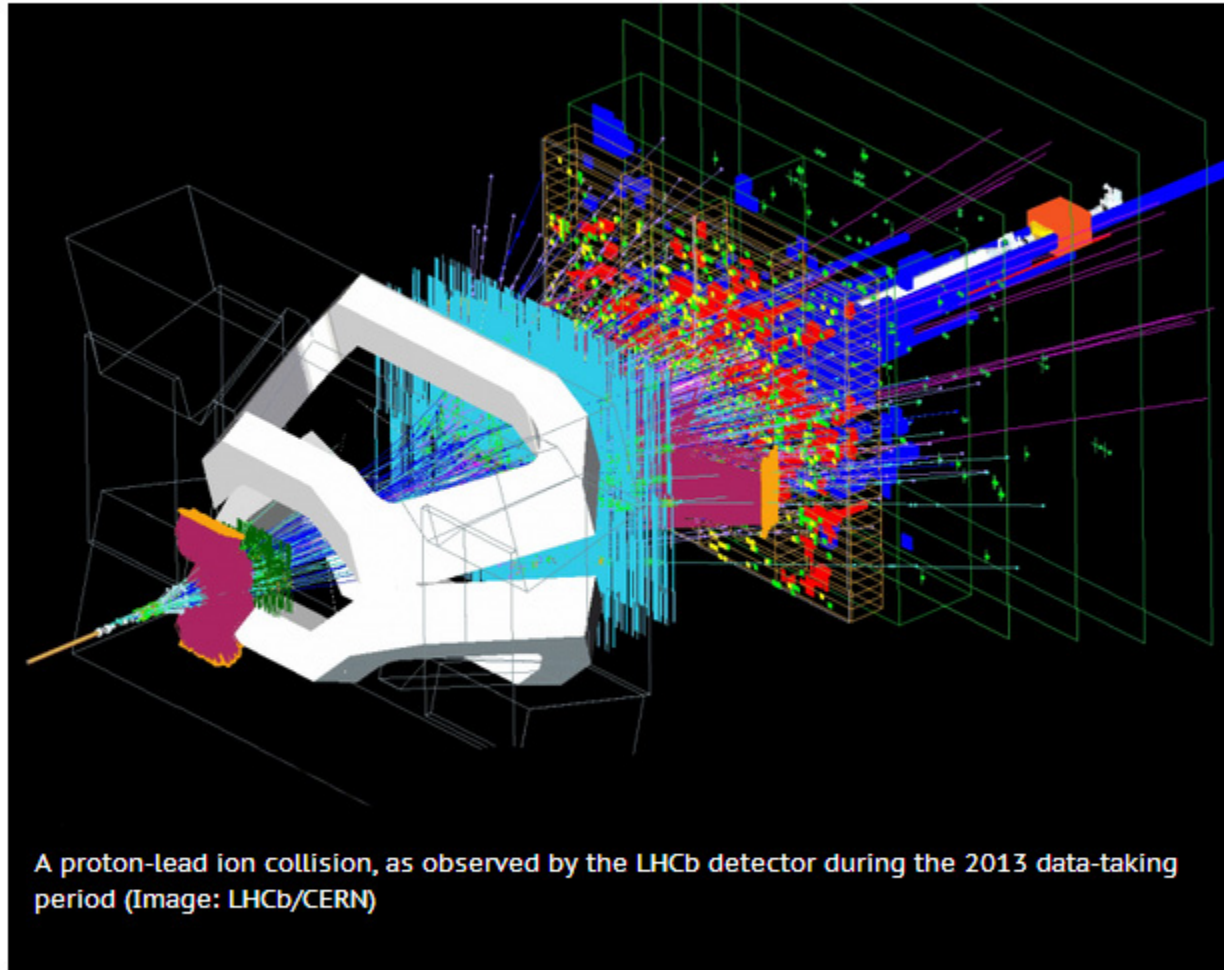

A proton-lead ion collision, as observed by the LHCb detector during the 2013 data-taking period (Image: LHCb/CERN)

During the [recent lead-proton](#) run at the [Large Hadron Collider](#) (LHC), the [Large Hadron Collider beauty](#) (LHCb) experiment took data from collisions between protons and ions for the first time.

# Why unequal frequencies?

- n The two LHC rings see identical strength but opposite sign magnetic field
- n The two RF systems are independent
  - At **injection** we have **4.7 kHz** difference between the two rings (at 400 MHz)
  - At the **end of the 4 TeV ramp** the difference is **60 Hz** only
- n On flat top we lock the two rings on the **same frequency**, resulting in a **+0.3 mm** offset of the p ring and **-0.3 mm** offset of Pb ring
- n We then gently **cog** the two rings to achieve crossing in the detector. It takes **11 minutes maximum** for the 27km long ring. The intersection point moves around *Pays de Gex* at **~150 km/h!**

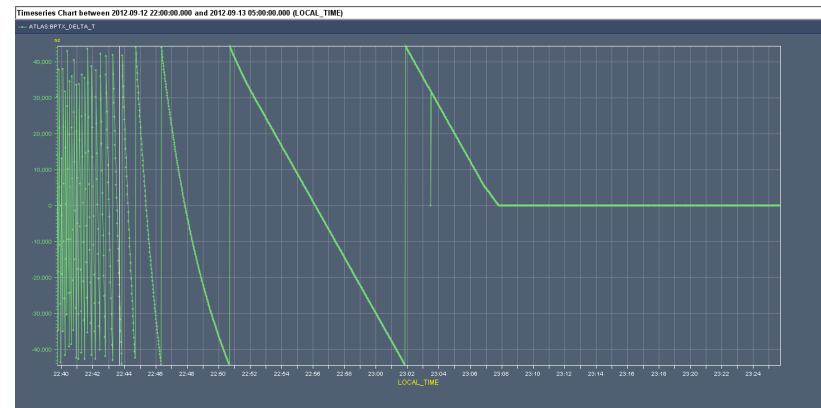
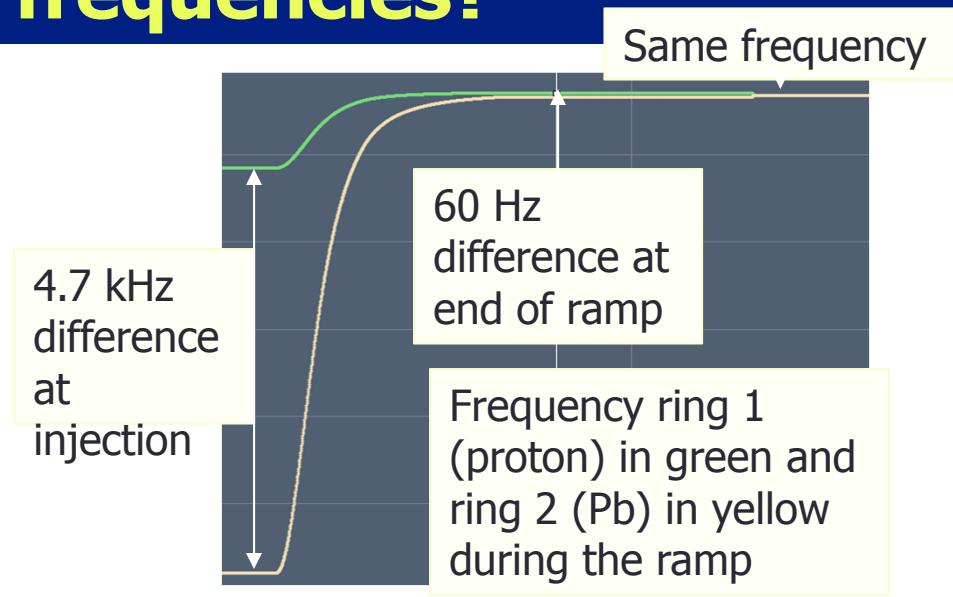

ATLAS BPTX from end-ramp to end-rephasing. Measures the time interval between passage of bucket 1 of both rings in the detector

# Beam performances over the run – emittances

2/2

M. Sapinski, M. Schaumann, G. Trad

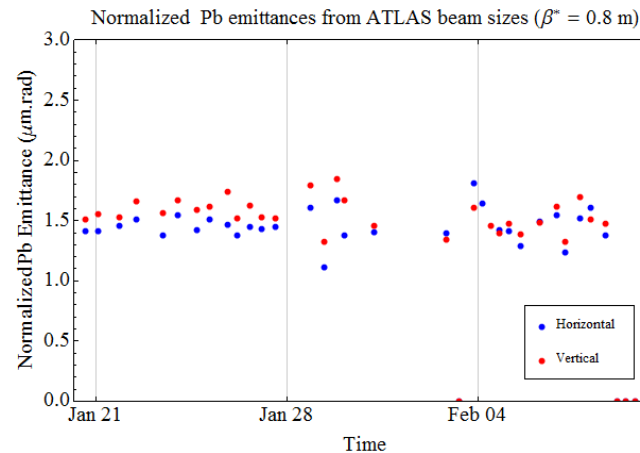
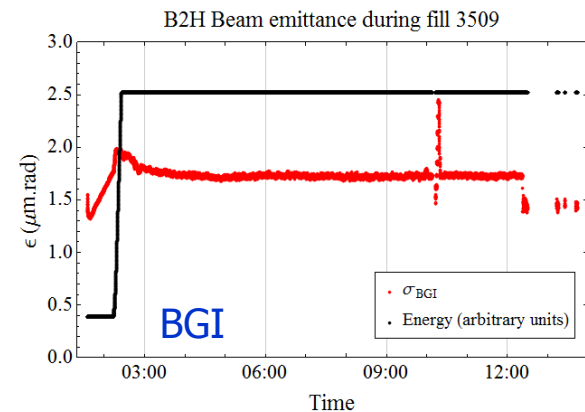
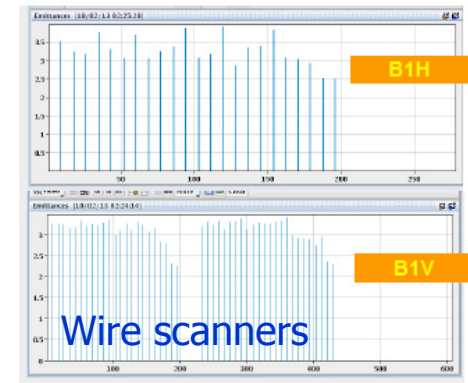
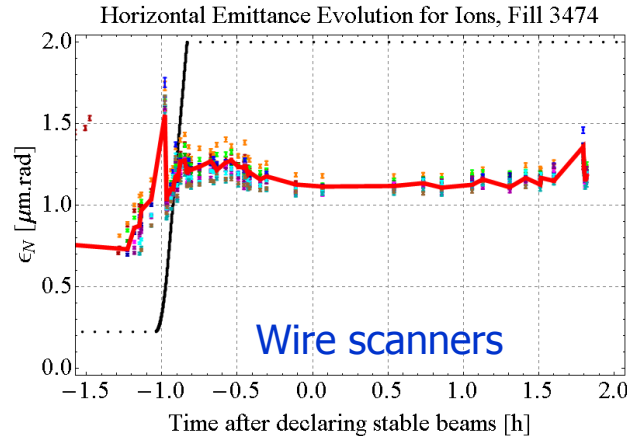
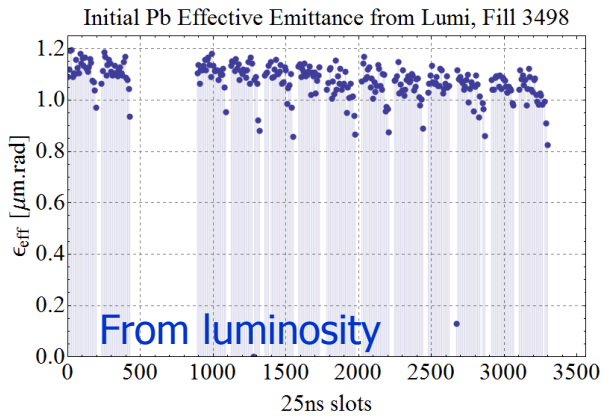

From ATLAS lumi data: stable emittance over the run, close to 1.5  $\mu\text{m}\cdot\text{rad}$  (=nominal)

- Wire scanners available during commissioning and Pb-p modes,
- BGI available for B2,
- BSRTs signal at injection very low  $\rightarrow$  set to mean over the bunches,
- Absolute calibration very difficult for all measurements,

### Baseline performance extrapolated from Pilot Fill

$f_0 \rightarrow 11245.5$ Hertz
$\sigma_{pPb} \rightarrow 2$ Barn
$\gamma_p \rightarrow 4263.16$
$\gamma_{Pb} \rightarrow 1693.45$
$\beta_{alice} \rightarrow 0.8$ Meter
$\beta_{atlas} \rightarrow 0.8$ Meter
$\beta_{lhcb} \rightarrow 2$ Meter
$N_{Pb} \rightarrow 1.2 \times 10^8$
$N_p \rightarrow 1.5 \times 10^{10}$
$k_b \rightarrow 318$
$k_{c15} \rightarrow 276$
$k_{c2} \rightarrow 276$
$k_{c8} \rightarrow 42$
$N_{exp} \rightarrow 3$
$E_{emittPbx} \rightarrow 1.4 \times 10^{-6}$ Meter
$E_{emittPby} \rightarrow 1. \times 10^{-6}$ Meter
$E_{emittpx} \rightarrow 1.7 \times 10^{-6}$ Meter
$E_{emittpy} \rightarrow 1.7 \times 10^{-6}$ Meter

	ATLAS	ALICE	CMS	LHCb
$N_{Pb}$	$1.2 \times 10^8$			
$N_p$	$1.5 \times 10^{10}$			
$\beta^*$	0.8	0.8	0.8	2.
$L/cm^{-2}s^{-1}$	$1.01 \times 10^{29}$	$1.01 \times 10^{29}$	$1.01 \times 10^{29}$	$6.14 \times 10^{27}$
$\mu$	0.065	0.065	0.065	0.026

Already close to ALICE maximum luminosity with emittances of pilot fill, good Pb intensity, fairly conservative proton intensity – **leaves room to try to increase it up to a factor  $\sim 3$**  (level ALICE if necessary).

Can easily be worse if we have blow-up or losses at injection or ramp (from moving encounters, IBS, ...).

Unequal beam sizes were OK in pilot fill with higher  $\beta^*$ . Emittance increase will probably reduce luminosity for all experiments and pile-up for ALICE.

This is our preferred first goal for the run. But, on the basis of present knowledge, it is by no means a “safe set of parameters” (except for optics).

- Proton intensity could not be increased further than  $1.8 \times 10^{10}$  charges because of BPMs bad readings (injection of  $3 \times 10^{10}$  p/bunch was tested on 17/01/2013),
- No obvious effects observed due to moving encounters at injection and during the ramp,
- Low intensity beams allowed us to get around beam-beam effects related to unequal beam sizes, or small separation for ‘bad’ polarity of ALICE...

# Beam-beam effects

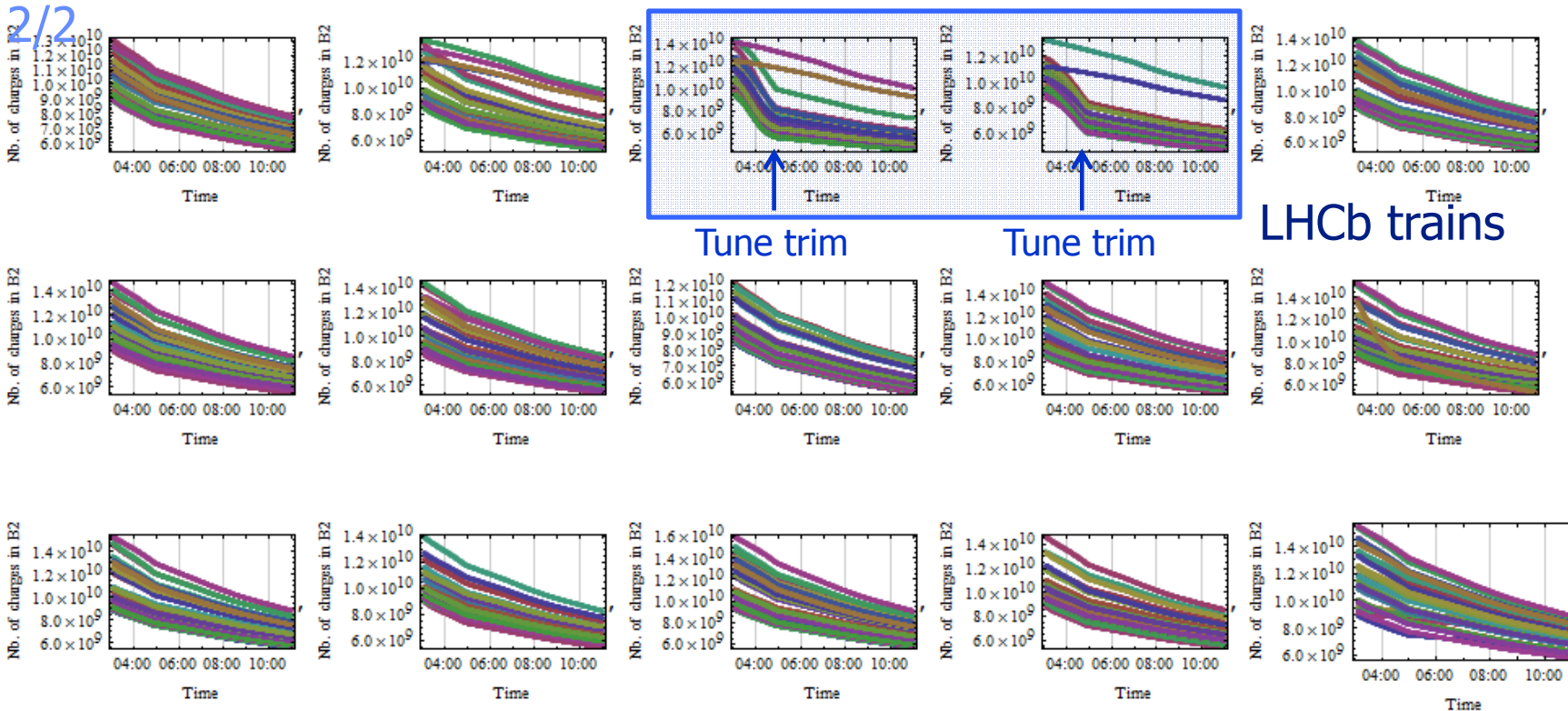

... but still beam-beam effects were there.

LHCb bunches in p-Pb configuration had parasitic encounters at small separation in IR2 ( $\approx 1\sigma$ ) and suffered more than the others from a small tune error (fill 3509).

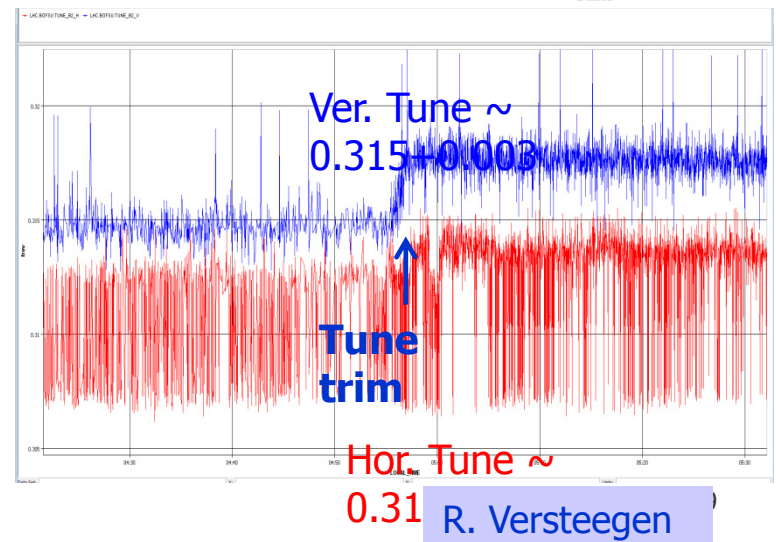

# Openings for future ion runs – batch by batch blow up at injection

2/2

- Batch by batch blow up to 1.4 – 1.6 ns at injection was tested to reduce IBS effect on transverse emittances,
- **No clear effect on p-Pb luminosity,**
- No clear conclusion from beam size measurements yet, analysis on going. IBS simulations results for 1.4 – 1.5 ns bunch length (M. Schaumann):

- *Horizontal emittance growth is **slowed down by >10%** after 30min*
- *Vertical emittance is not affected (as expected)*

- *Losses are **enhanced for blown up bunches** by about **~5%** after 30min*

## Compare Best with Average Bunch

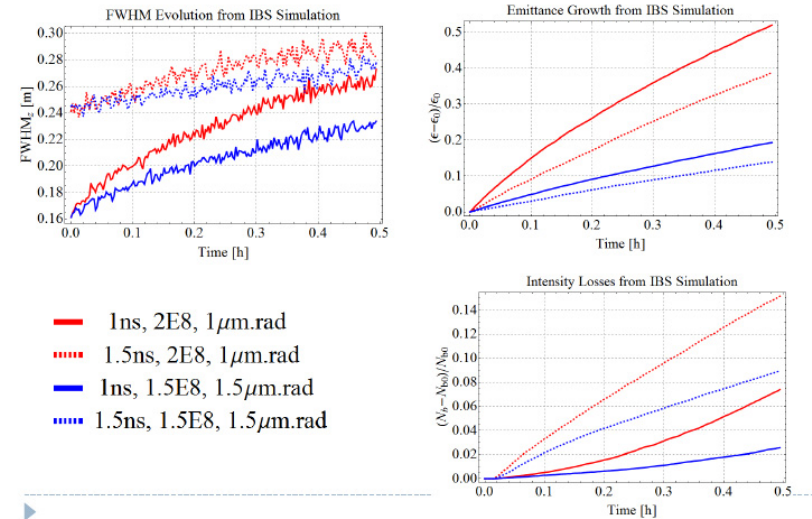

## Intensity after injection

M. Schaumann

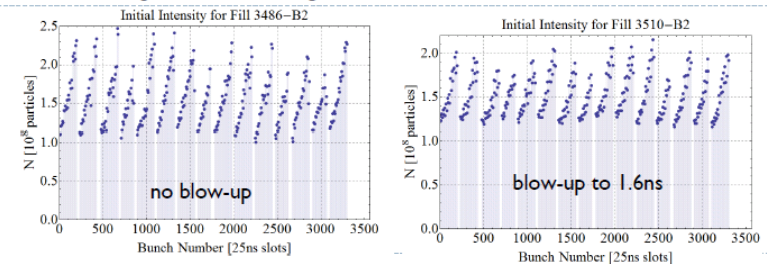

## Bunch length after injection

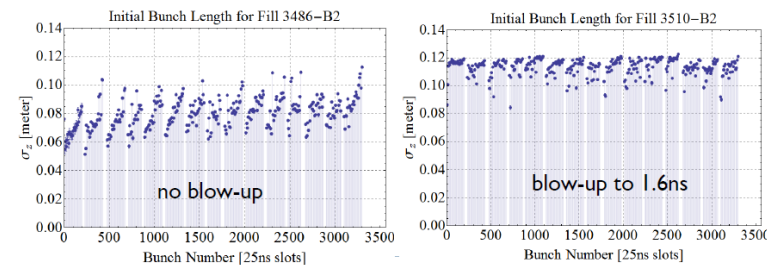



# Choice of operating energy for p-Pb in 2012

Charges  $Z_1, Z_2$  in rings with magnetic field set for protons of momentum  $p_p$  :  
colliding nucleon pairs have:

$$\sqrt{s_{NN}} \approx 2c p_p \sqrt{\frac{Z_1 Z_2}{A_1 A_2}},$$

$$y_{NN} = \frac{1}{2} \log \frac{Z_1 A_2}{A_1 Z_2}$$

2.2 ZTeV “ideal” but would cost factor  $\sim 6-7$  in integrated luminosity and exceeds 1 mm orbit limit in LHC arcs.

4 ZTeV, the final choice for 2012, will be “easiest” from accelerator point of view.

