

RF TUNING OF THE LINAC4 RFQ

O. Piquet, M. Desmons, A. France A. France, Y. Le Noa, J. Novo,
CEA, IRFU, Gif-sur-Yvette, France
C. Rossi, CERN, Geneva, Switzerland

Abstract

The construction of Linac4, the new 160 MeV CERN H- injector, has started with the goal of improving the LHC injection chain with a new higher energy linac. The low energy front end of Linac4 is based on a 352 MHz, 3-m long Radiofrequency Quadrupole (RFQ) which accelerates the 70 mA, 45 keV H- beam from the ion source to the energy of 3 MeV. The RFQ, made of three modules, one meter each, is of the four-vane type and it has been designed in collaboration between CERN and CEA. Construction has started in 2009 and all the steps of machining and assembly have been done at CERN. The RFQ is equipped with 35 fixed tuners and one waveguide RF port located in the second module. This paper describes the procedure used to tune the accelerating field and the power coupler of the LINAC4 RFQ in order to achieve the nominal voltage profile within $\pm 1\%$ accuracy.

INTRODUCTION

Linac4 RFQ is a 3-meter single segment RFQ (Fig. 1). Specified voltage is constant over full RFQ length, in order to simplify RF design and mechanical fabrication. Design of RFQ end-circuits is intended to provide adequate boundary conditions for voltage tuning and low sensitivity to dipole-like perturbations. Boundary conditions are tuned with quadrupole rods (QR) inserted in end plates. Electrical parameters of RFQ however vary slightly vs. abscissa, as a consequence of vane modulations. Resulting voltage error is 10% at most, and is easily suppressed with the 36 tuners (8 slugs and 1 RF port per quadrant). Tuners are also designed to compensate for construction errors. Envelope of fabrication tolerances may yield inter-vane capacitance errors of 2.3% (quadrupole-like errors) and/or 3.5% (dipole-like errors). RF power is coupled with one iris and a ridged waveguide matching section.

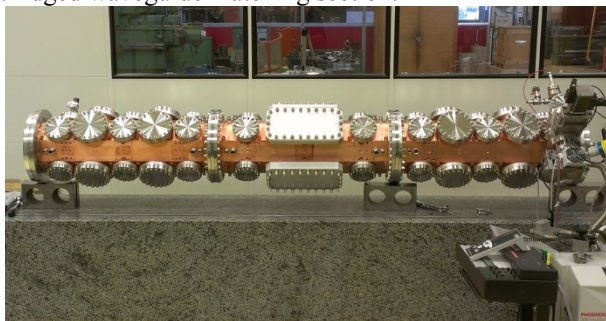

Figure 1: 3 meters Linac4 RFQ.

RF CONTROL

After each fabrication step, (after first manual assembly, first brazing and second brazing), bead-pull

measurements are performed [1]. By sampling electromagnetic fields in the four RFQ quadrants, bead-pull measurements may disclose errors in the fabrication process that, in the end, may produce a modification of the accelerating field profile with respect to design. Results are displayed in Figure 2, where successive fabrication steps are identified with color code. Typical precision of the method is ± 0.003 , after processing typically 5 or 6 beadpulls. Black traces apply to the full-length assembled RFQ, before its final tuning, and nicely follow individual 1-meter long sections estimates. All capacitance errors never exceed 1%, well within specifications.

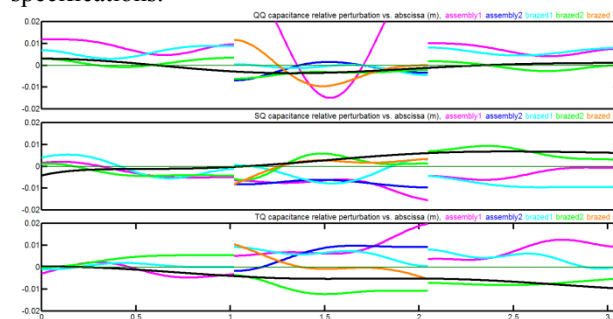

Figure 2: Capacitance errors for quadrupole (QQ) and dipole modes (SQ and TQ) in the assembled RFQ.

END CIRCUITS TUNING

The tuning of the end regions, with respect to the quadrupole mode, is made by using aluminum end-plates with adjustable rods. For different lengths of rods, end voltages and voltage slopes are derived from bead-pull measurements, using the excitation set method [3]. Figure 3 presents measurement and RF simulation results. Measured values with test end-plates are in green, Comsol simulated values are in blue and final values with copper plate are in red and cyan. The rod length at the output plate has been set to 53 mm, as a compromise between tuning and stability.

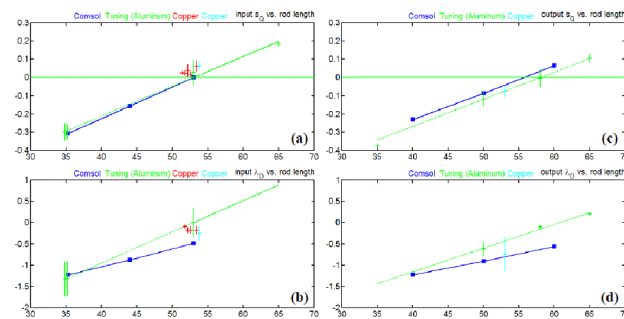

Figure 3: End boundary conditions.

SLUGS PRE-TUNING

Positions of the 32 slugs and 4 dummy RF blocks are adjusted in order to achieve the required resonance frequency and voltage profile of the accelerating mode, via the iterated procedure described in [3]. The closed-loop control-command tuning algorithm is sketched out in Figure 4. A linear filter-bank derives voltage spectral components (12 in each Q, S, T subset in the present case) from valid measured samples (the controlled quantities).

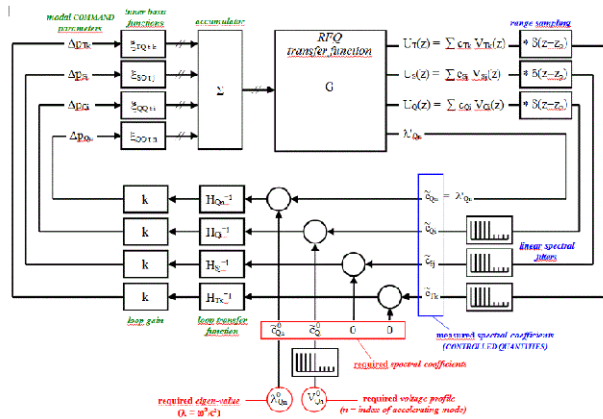

Figure 4: Tuning Algorithm.

First-order perturbation analysis of SL operator is used to build the dual basis of tuner functions (with dim. 9 in each subset). Measured spectral coefficients are compared to desired ones (i.e. spectral coefficients of specified voltage function in quadrupole subset, all zeroes in dipole subsets). Inverse RFQ transfer function is then applied to elaborate command parameters in each spectral channel. After about ten tuning iterations, voltage errors are reduced from 23% down to ~1% (Fig. 5).

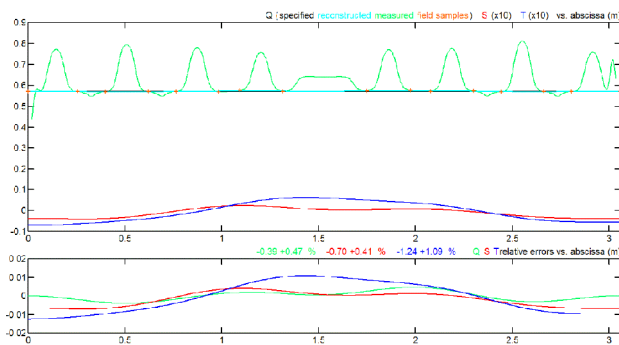

Figure 5: Voltage profile before RF coupling tuning.

RF COUPLING TUNING

RF power is fed to the RFQ by an iris coupler located in quadrant #4. The feeder line consists of a half-height W3200 waveguide, followed by a ridged quarter wavelength transformer ("ridge 2") and a ridged waveguide with smaller aperture ("ridge 1") (Fig. 6).

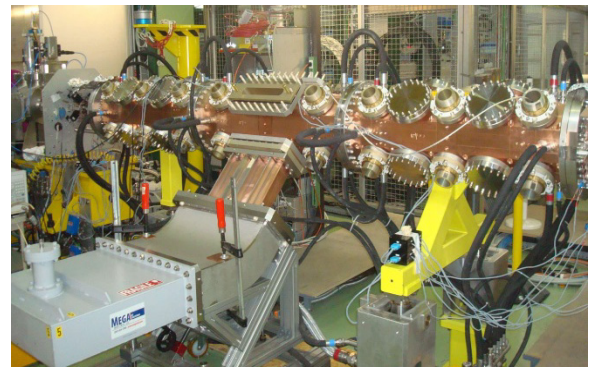

Figure 6: RF coupling.

The iris itself is a slit terminated by two circular openings (Fig. 7). Common diameter d_c of these openings and position h_c of iris plate inside the RFQ must be adjusted to achieve both critical coupling of beam-loaded cavity and minimum voltage profile perturbation.

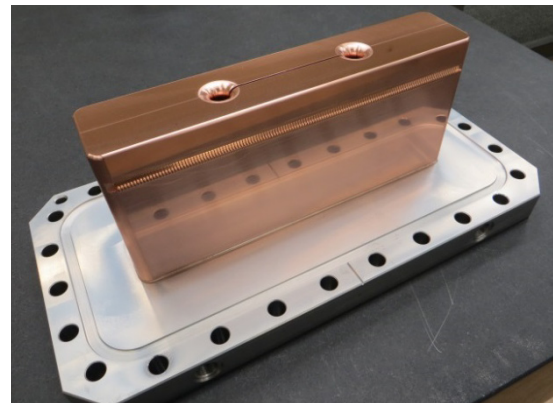

Figure 7: Ridge 1 with iris.

RF coupling coefficient without beam needs to be specified, since tuning operations are of course performed without beam. Reflection coefficient at coupler input is s_{11} and may be defined by the following relation:

$$s_{11} = \frac{P_B - P_L}{2P_{Cu} + P_B + P_L}$$

where P_{Cu} represents copper losses, P_L is additional losses due to tunable aluminum pieces and $P_B=210$ kW is beam power. P_{Cu} and P_L have been derived from measurements during tuning operation and have been estimated to 349.7kW and 160 kW respectively.

Dummy RF block in quadrant #4 is replaced by "ridge 1 + iris" assembly. Measurements have been acquired for different diameters of the iris and different positions inside the RFQ. Voltage perturbation induced by the RF port is characterized with T2 spectral component c_{T2} . Tuned values of d_c and h_c will be obtained by interpolation, using specified value of s_{11} . Figure 8 represents iso- s_{11} lines (in blue) and iso- c_{T2} lines (in red), in the $\{d_c, h_c\}$ plane. Final dimensions (d_c, h_c) of copper iris have been derived for this tuning chart according to the s_{11} specification.

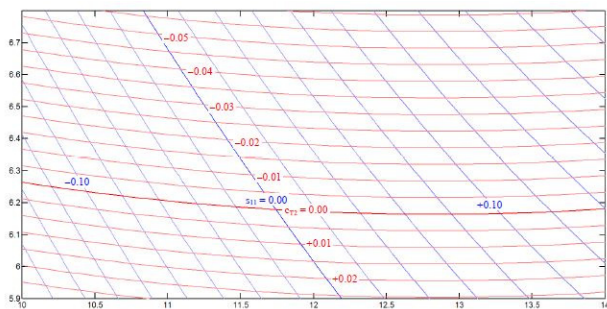

Figure 8: Tuning chart iso- s_{11} lines (in blue) and iso- C_{T2} lines (in red), in the $\{d_c, h_c\}$ plane.

SLUGS FINAL TUNING

Once copper iris and RF blocks have been inserted, the position of the 32 slugs is re-adjusted to compensate for final frequency and/or voltage errors. Some tuning steps are needed to obtain the 1% flatness required on the voltage profile (Fig. 9).

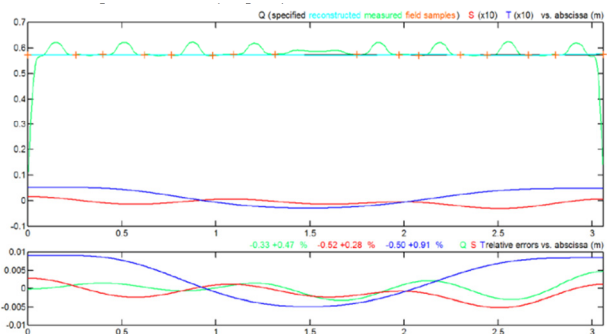

Figure 9: Voltage profile after last tuning step.

Final (Q, S, T) voltage errors are (0.47, 0.52, 0.91) %, all within 1% requirement. Tuner positions are in the interval [9.02, 12.11] mm, well within specified range. Tuned frequency anticipating vacuum detuning is 352.1 MHz. Closer dipole mode is D2 at 353.5 MHz.

TUNING CHECK WITH COPPER SLUGS

Positions of adjustable tuners have been accurately measured. Copper tuners have been machined accordingly and inserted in the RFQ. Beadpull measurements have been realized to check the final voltage profile (Fig. 10).

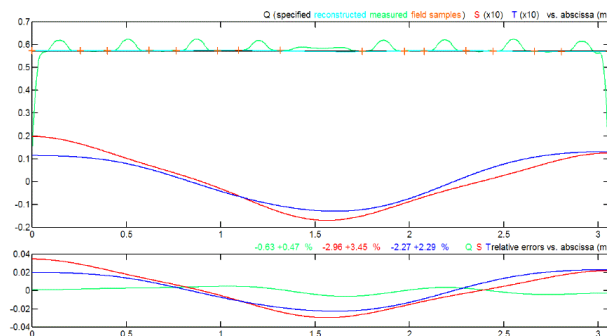

Figure 10: Final voltage profile.

Voltage Q-component error is virtually unchanged. Voltage S-component error is primarily dominated by S2 and S6 components, and voltage T component error is essentially T2. Tuned frequency is 352.065 MHz, i.e. 35 kHz lower than expected. This suggests that copper tuners might be slightly less efficient (by 0.53%) than adjustable ones.

RF COUPLING CHECK

RF coupling is measured with all definitive RFQ parts. Measured s_{11} is found to be higher than expected, but quite close to requirement. This fact may result from geometrical differences between aluminum iris used for tuning and final copper iris.

In operation at nominal inter-vane voltage, the RFQ would dissipate 387.9 kW, 38.2 kW higher than the 349.7 kW comprehensive estimate obtained at RF coupling tuning step. Estimated reflected power is 20.3 kW. With a 210 kW beam, forward power would be 598.1 kW and reflected power would be 0.16 kW.

CONCLUSION

RF tuning of the LINAC4 RFQ has been accomplished in 4 month. Main difficulties consisted in replacing tunable parts by electromagnetically equivalent final copper pieces. Small mechanical differences between these parts led to voltage errors outside the 1% requirement and a new iteration of the RFQ tuning is recommended before its installation in the Linac4 tunnel. Voltage profiles will be measured during the RFQ operation thanks to 16 pickups inserted in copper tuners. First results of conditioning and commissioning are presented in a companion paper [4].

ACKNOWLEDGMENT

The authors are pleased to acknowledge the enthusiastic contribution of CERN's BE/RF and TE/USC teams for the mechanical and vacuum support during the installation and measurement campaign.

REFERENCES

- [1] C. Rossi and al. "Assembly and RF tuning of the LINAC4 RFQ at CERN," LINAC12, Tel-Aviv, Israel, THBD038
- [2] O. Piquet et al., "The RF Design of the Linac4 RFQ" IPAC10, Kyoto, Japan, MOPD026
- [3] O. Piquet, M. Desmons, A. France, "Tuning Procedure of the 6-Meter IPHI RFQ", EPAC'06, Edinburgh, Scotland, MOPCH107.
- [4] C. Rossi and al. "Commissioning of the Linac4 RFQ at the 3 MeV Test Stand", these proceedings.