

# PROGRESS IN REDUCING THE BACK-BOMBARDMENT EFFECT IN THE ITC-RF GUN FOR t-ACTS PROJECT AT TOHOKU UNIVERSITY

X. Li<sup>\*A)</sup>, S. Kashiwagi<sup>A)</sup>, M. Kawai<sup>A)</sup>, F. Hinode<sup>A)</sup>, K. Nanbu<sup>A)</sup>,  
 T. Muto<sup>A)</sup>, F. Miyahara<sup>B)</sup>, Y. Tanaka<sup>A)</sup>, H. Hama<sup>A)</sup>,  
<sup>A)</sup>Electron Light Science Center, Tohoku University, Sendai, Japan  
<sup>B)</sup>KEK, Tsukuba, Japan

## Abstract

An ITC (independently tunable cells) thermionic RF gun has been developed as the electron source for coherent terahertz radiations at Tohoku University. Both experiments and simulations have shown that the back-bombardment (B.B.) effect on the LaB<sub>6</sub> cathode is a serious issue for stable operation. A numerical model has been developed to evaluate the increase of the cathode temperature due to B.B. in which the 2D equation for heat conduction is solved by taking the back-streaming electrons into account. Using this model we have studied the possibility of suppressing the B.B. by imposing external dipole field and by optimization of the cathode size, compared with experimental data. The results will be reported here.

## INTRODUCTION

In recent years the terahertz radiation has drawn worldwide attention because of the unique properties of interactions with matter. It can be applied in many fields, such as THz imaging in medicines and securities. Among the terahertz sources, the accelerator-based one can provide coherent, high average power radiations. At Tohoku University, a test-Accelerator as Coherent Terahertz Source (t-ACTS) project [1] is currently under construction, as shown in Fig. 1. This project will make use of very short electron bunches (~100 fs) which ensure the coherence of radiations at THz band either in the isochronous ring or in the undulator.

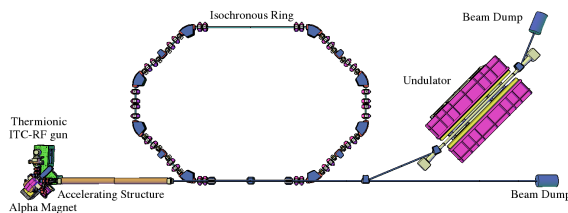

Figure 1: Layout of the t-ACTS project.

To meet the requirements, a thermionic RF gun consisting of two independently tunable cells (ITC) has been developed. The gun is equipped with a single crystal cathode of LaB<sub>6</sub> because of the high emission current density (~50 Acm<sup>-2</sup>). The cathode size is very small (Φ1.75 mm) to maintain a good emittance. Simulations have suggested

that an electrical field strength of 25 and 70 MV/m for the first and second cells and a phase difference of  $\pi + 24^\circ$  can provide a good energy chirp [2] for bunch compression in the downstream alpha-magnet. The bunch head with charge of 20 ~ 30 pC will be filtered by the alpha-magnet and further compressed by velocity bunching in the main accelerators. In the case of 100 fs in rms length and 20 pC in charge for the bunch, the peak power per optical pulse from the undulator is expected to be 5 ~ 8 kW [3].

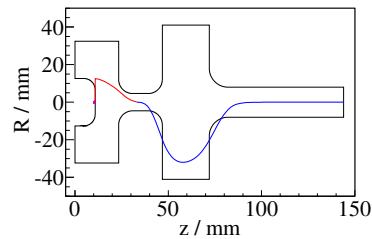

Figure 2: The ITC-RF gun and its field.

Since the RF field is oscillating in time, electrons emitted late in the RF period can't cross the gun before the field reverses. They will experience decelerating force and turn back to the cathode. As a result, the cathode is over-heated and the emission current goes up. This phenomenon is the so-called back-bombardment (B.B.) effect [4, 5].

## CHARACTERISTICS OF B.B.

The back-streaming electrons can be classified into two major groups called the first and the second group, respectively. The first group originates in the first cell and is still close to the cathode when turning back. Electrons in this group have very low kinetic energies (< 200 keV in our case). By contrary, the second group originates in the second cell and reaches the cathode with relatively high energies (< 1.3 MeV). The energy spectrum of B.B. was shown in Fig. 3. Although most of the back-streaming electrons belong to the first one, the two groups contribute almost same total backbombarding energies to the cathode. The simulated B.B. power was 6.9 kW and 9.3 kW, respectively.

After entering the cathode, the electrons lose their energies through collision and radiation. The loss by radiation is nearly negligible at low energies while that by collision can be expressed by the Bethe-Bloch formula which gives

\* lixiangkun05@sina.com

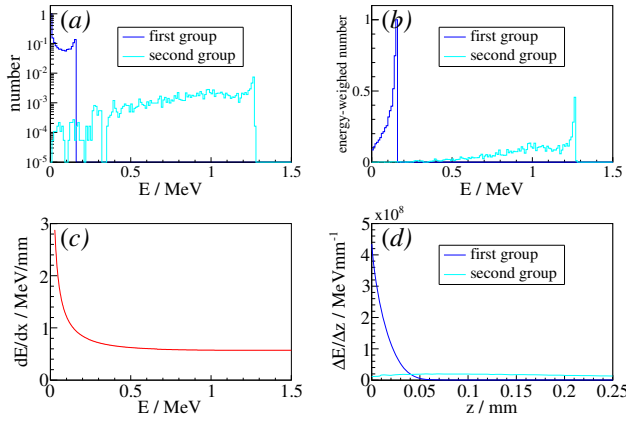

Figure 3: (a) is the energy spectrum of B.B.; (b) is that weighed by energy; (c) is the stopping power of LaB<sub>6</sub> and (d) is longitudinal distribution of energy deposits inside the cathode.

the stopping power of matter,  $-dE/dx$ , as

$$-\frac{dE}{dx} = 2\pi N_a r_e^2 m_e c^2 \rho \frac{Z}{A} \frac{1}{\beta^2} \left[ \ln \frac{\gamma^2 (\tau + 2)}{2(I/m_e c^2)^2} + F(\gamma) - \delta - 2 \frac{C}{Z} \right], \quad (1)$$

where  $N_a$ ,  $r_e$ ,  $m_e$  and  $c$  are physical constants,  $\rho$ ,  $Z$ ,  $A$  the density, atomic number and weight of the material,  $\beta$  and  $\gamma$  the relativistic factors,  $I$  the mean excitation potential,  $\delta$  and  $C$  the density and shell correction, respectively.

Based on the above formula we calculated the stopping power of LaB<sub>6</sub> for electrons. As shown in Fig. 3 the stopping power for the first group is much higher than the second group, implying the first group will lose much of their energies near the cathode surface. It was confirmed after calculating the energy deposit of all the back-streaming electrons inside the cathode. The information of these electrons was obtained by particle tracking in the RF gun by GPT [6] and the energy deposit was accomplished by Geant4 [7]. The fact that the extra heat near the cathode surface is mainly contributed by the first group means this group should be controlled reasonably.

## THE 2D MODEL

The 2D model is aimed to evaluate the B.B. effect on the cathode as time. As shown in Fig. 4, the particle tracking is done at first by GPT, given the initial conditions such as the emission current density and the RF parameters. The positions and momenta of back-streaming electrons are then introduced to Geant4 to calculate the energy loss inside the cathode.

The deposited energies will heat the cathode together with the heating power from the cathode heater and thermal radiations from the surface. This process can be described by the 2D equation for heat transfer as follows

$$\rho C \frac{\partial T}{\partial \tau} = \lambda \left[ \frac{\partial^2 T}{\partial x^2} + \frac{1}{r} \frac{\partial}{\partial r} \left( r \frac{\partial T}{\partial r} \right) \right] + S, \quad (2)$$

where  $T$  is the temperature,  $\tau$  the time,  $\rho$ ,  $C$  and  $\lambda$  the density, heat capacity and thermal conductivity of the material,  $S$  the heat source. At equilibrium state, that is, no emission current and no B.B., the heating power should equal the thermal radiation power.

Finally the temperature is related to the emission current density by the Richardson's equation

$$J_0(T) = AT^2 e^{-\frac{W}{kT}}, \quad (3)$$

Where  $J_0$  is the emission current density,  $A$  the Richardson's constant,  $k$  the Boltzmann's constant,  $W$  the work function of the material.

The loop in Fig. 4 means the information of back-streaming electrons should be updated according to the latest temperature distribution on the cathode surface. However, as it takes long time to implement the particle tracking we only do it once and use it repeatedly through the simulation. Besides, the filling process of the RF power and the beam loading in the gun are omitted. So the preferred peak electrical field strengths, 25 and 70 MV/m are taken during the whole simulation.

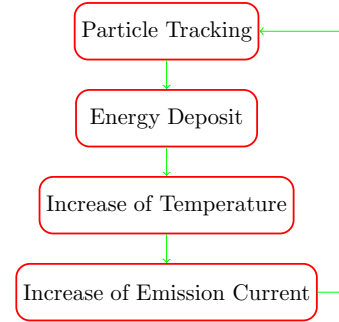

Figure 4: Procedure of the 2D model.

## SUPPRESSION OF B.B. BY A DIPOLE MAGNET

### Considerations On Dipole Field

A dipole magnet can generate a transverse magnetic field to deflect the back-streaming electrons away from hitting the cathode. Taking a uniform magnetic field as an example, simple derivations give that  $\Delta y = L \tan(\theta/2)$ ,  $\sin\theta = eBL/P$ , where  $y$  is the direction the electron is bended,  $L$  the distance the electron has travelled in its original direction,  $B$  the field strength,  $P$  the electron momentum. Since the deflection angle  $\theta$  is very small,  $\Delta y \sim L^2 eB/2P$  or  $\Delta y \propto L^2/P$ .

As mentioned before, the two groups of B.B. have different positions and energies, corresponding to  $L$  and  $P$  in the above relationship. However, simulations showed that the quadratical dependence on  $L$  takes a leading role rather than  $P$ . For the first group, only half of the B.B. power can be removed with a field of 120 G. For the second group, the B.B. power can be completely eliminated with the field

strength exceeding 20 G. Considering the energy deposit in the cathode, only moving the second group is far from enough to suppress the B.B. effect.

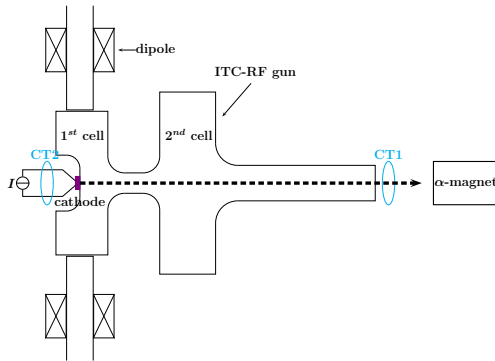

Figure 5: Setup of the gun and the dipole magnet.

### Comparison Of Experiments And Simulations

We made a simple dipole magnet which can provide a magnet field of  $\sim 80$  G near the cathode surface. To monitor the effect of the field, the beam currents at the gun exit were measured by CT1 in Fig. 5. Since the outgoing beam is also affected, we should separate the change in beam current by the loss to the wall of the gun from that by the improvement in B.B.. For this reason the emission currents from the cathode were also estimated indirectly from the current measured by CT2 in Fig. 5. In simulations, the distribution of magnetic field calculated by CST [8] was included in particle tracking codes of GPT.

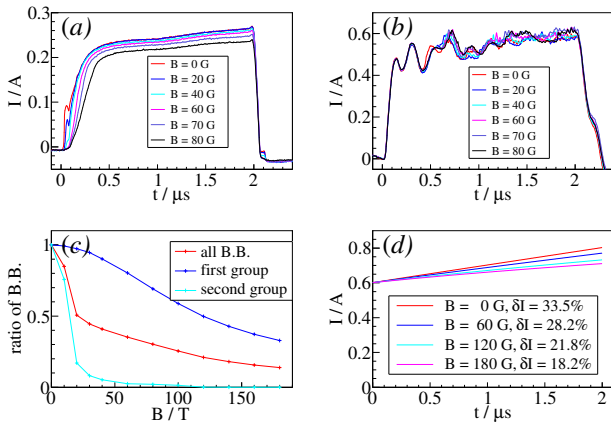

Figure 6: (a) is beam current measured by CT1 in Fig. 5 and (b) is emission current measured by CT2. (c) is the B.B. power with dipole field and (d) is the emission current from simulations.

Figure 6 showed that the emission current wasn't notably affected by the dipole field as the beam current did. Since the increase of emission current was of the same order, the dipole magnet seemed helpless with the B.B.. The experimental results were further confirmed with the simulation, also shown in Fig. 6. The results were consistent with the

previous analysis. Besides, the transverse emittance was also deteriorated by the dipole field.

### OPTIMIZATION OF THE CATHODE SIZE

Experiments have shown the B.B. effect is negligible for the same cathode only when the emission current is low enough. But such small current cannot meet the demand of the t-ACTS project. However, if we adopt a smaller emission current density while raising the emission area at the same time, the same current can be achieved with the B.B. improved probably. Regarding the cathode size, two phenomena should be noted. First, the space charge effect will be reduced with the decreasing of the emission current density. It means more electrons will hit the cathode, although the cathode size is larger. Second, the thermal emittance as well as the beam size is relevant with the emitter's area or radius, very large cathode shouldn't be appropriate. Using the 2D model, we studied the B.B. with different cathode size and found the radius of  $\sim 1.5$  mm was a good choice with an acceptable increase in emission current and in transverse emittance, as shown in Fig. 7.

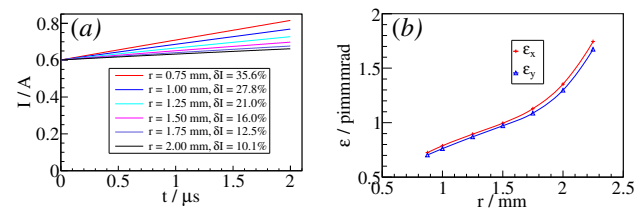

Figure 7: (a) shows the increase of emission current and (b) shows the transverse emittance with different cathode size.

### SUMMARY

A 2D model was built to evaluate the B.B. effect on the cathode in a thermionic RF gun, by which the increase of emission current during a macro-pulse can be simulated. An external dipole field was proved helpless with the B.B. by both simulations and experiments. A larger cathode radius of 1.5 mm was recommended but needs confirmed by experiment in the future.

### REFERENCES

- [1] H. Hama, et al. New J. of Phys., 8:292, November 2006.
- [2] F. Miyahara, et al. In Proc. of IPAC'10, pages 4509 – 4511, Kyoto, 2010.
- [3] F. Hinode, et al. Nucl. Instrum. Meth. A, 637:S72 – S75, 2011.
- [4] C.B. McKee and John M.J. Madey. Nucl. Instrum. Meth. A, 296:716 – 719, 1990.
- [5] M. Borland. A High-brightness Thermionic Microwave Electron Gun. PhD thesis, Stanford University, April 1991.
- [6] General Particle Tracer. <http://www.pulsar.nl/gpt>
- [7] GEometry ANd Tracking. <http://geant4.cern.ch/>
- [8] CST. [www.cst.com](http://www.cst.com)