

# DESIGN OF A STRIPLINE KICKER FOR TUNE MEASUREMENT IN CSNS RCS

Xiaoyu Yang, Shinian Fu, Taoguang Xu, IHEP, Beijing, China

## Abstract

For CSNS RCS tune measurement, tune value is measured by exciting the bunch with strip-line kicker fed with white noise and using FFT algorithm to the turn-by-turn position of the bunch in the BPM. This article simulates the strip-line kicker in RCS and the efficiency of the kicker is discussed in the MATLAB environment. The parameters of the kicker with arc electrode structure such as wake impedance, thermal state and VSWR are analyzed based on the advantage of this design.

## KICKER IN THE MATLAB ENVIRONMENT

CSNS RCS is designed to accelerate proton beam to 1.6GeV at 25Hz repetition rate, during this process, the cyclotron frequency of beam is changed from 0.51MHz to 1.21MHz. The design tune of RCS  $Q_x/Q_y$  is 4.86/4.78, and the harmonic number  $h$  is 2 [1]. The bunch is planed to be excited by the kicker fed with white noise and turn-by-turn position in the BPM will be used to get the tune value. For RCS, it is enough to choose frequency range of white noise from 0 to 5MHz.

Accelerator Toolbox is a collection of tools to model particle accelerator and beam transport lines in the MATLAB environment [2]. Every element is defined and arranged in the correct sequence. After that, RCS is established, and the performance of kicker can be simulated in the MATLAB environment [3]. Figure 1 shows the layout of lattice of RCS in the MATLAB environment and the position of kicker is determined. Horizontal and vertical tune are required to be measured in practice, therefore two kickers are needed for each direction.

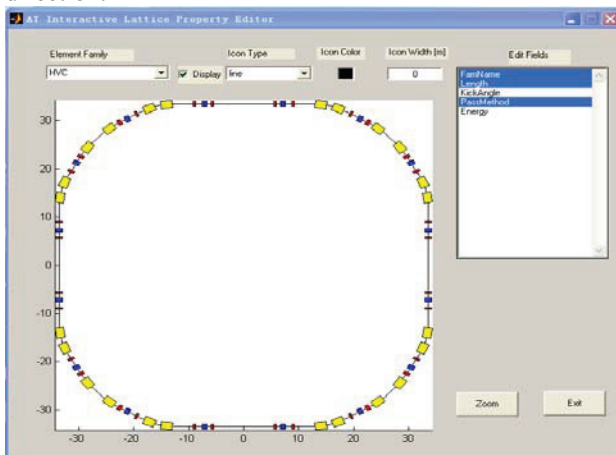

Figure 1: The layout of lattice of RCS in the MATLAB environment.

## SECTION DESIGN

Three possible designs have been considered to start with the design of the kicker, such as arc electrode, planar electrode without angle and planar electrode with angle [4]. The characteristic impedance of each one has been calculated and optimized to 50 Ohm with Superfish code. Figure 2 shows these three types of section of the kicker and Table 1 shows the dimensions of these three designs.

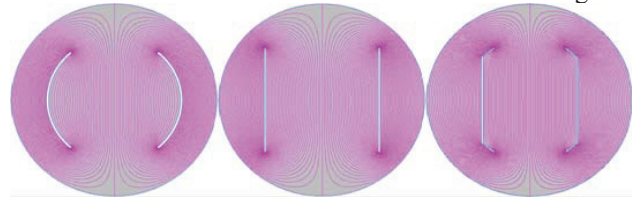

Figure 2: Three types of section of the kicker.

Table 1: Dimensions of these three designs

Aperture:85mm	Aperture:85mm	Aperture:85mm
Radius:133mm	Radius:156mm	Radius:187mm
Coverage:98°	Planar:170mm	Planar:170mm
Length:980mm	Length:980mm	Length:980mm
Thickness:3mm	Thickness:3mm	Thickness:3mm
Z=50.18 Ohm	Z=50.24 Ohm	Bend:125°
		Border:25mm
		Z=50.16 Ohm

Every design has its own merits and demerits. In general, the parameters such as wake impedance, VSWR, loss factor and thermal property should be calculated and analyzed. In principle, not every parameter can be optimum, so we try to get a balance to make the overall performance better.

From the standpoint of restraining collective instability, wake impedance is important, so wake impedance of these designs is discussed first to find a primary design.

## CALCULATION OF WAKE IMPEDANCE

When beam traverses a discontinuity in the strip-line kicker, an electromagnetic “wakefield” is generated, because the image charges moving along the structure now have to move around a corner. To get a handle of this, usually introduce a quantity called “wake functions”. The time-domain calculation of the wake functions and the frequency-domain calculation of the impedances are completely equivalent. They are related by Fourier Transforms. Here we use CST Particle Studio to calculate wake impedance of each design [5]. To calculate accurately, we should use as short as a driving bunch as possible. Since each design has the axial length about 1m, we choose 20mm as sigma value of driving bunch, and the bunch has a horizontal offset 20mm to the structural

center of the kicker. The kicker is made of stainless steel and the number of mesh is more than 4 million for each model. Figure 3 shows the electric field when one short bunch travels along the arc electrode kicker and Figure 4 shows the amplitude of wake impedance in z direction of three kickers

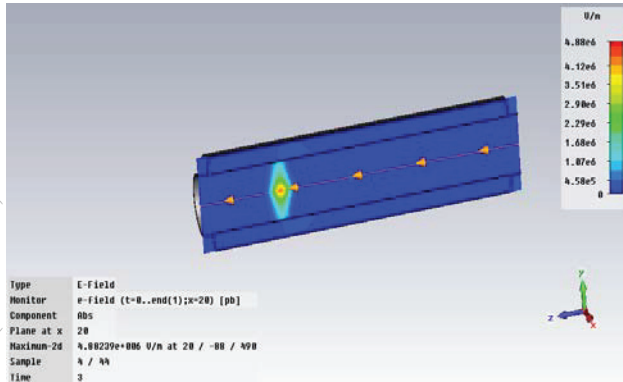

Figure 3: The electric field when one short bunch travels along the arc electrode kicker.

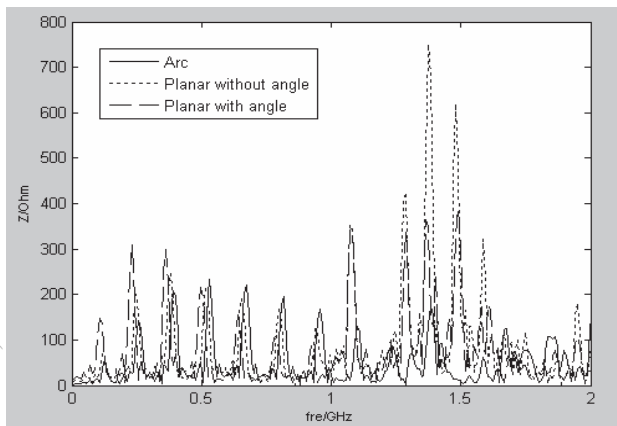

Figure 4: The amplitude of wake impedance in z direction of three kickers.

Below frequency 2GHz, arc electrode kicker has less wake impedance value, it means that bunch will loss less power in this structure than other two designs, and it is helpful to restrain the instability of bunch during running. The peak value is about 240 Ohm and accepted from the standpoint of physics tolerance.

### CACULATION OF LOSS FACTOR AND THERMAL STATE OF THE KICKER

The kicker is made of lossy material stainless steel, so there will be deposit of power in the electrode more or less, though most of power is absorbed by the terminal matching load. The power loss due to long bunch is considered. Here we choose 10m as sigma value for standard deviation of the Gaussian shaped bunch, and the wake loss factor we obtain is 9.72e-8V/pC. Considering there are two bunches in RCS and each bunch contains 1.56e13 particles. The average current, 3A is considered, and the power loss calculated is 1.75W.

Most of power is absorbed by the terminal matching

load and result shows the deposit is far less than 1W. Thermal state of arc electrode kicker is calculated using ANSYS [6]. As a conservative estimate, we assume initial temperature is 20°C, the deposit 1W is assigned to the electrode uniformly and the outside surface of the kicker meets the condition of natural convection. For a transient process from 0 to 300s, the temperature of electrode hardly changes. Figure 5 shows the temperature distribution of the kicker in 300 seconds.

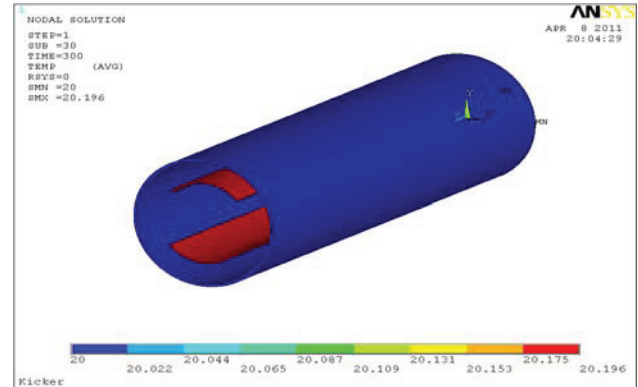

Figure 5: Temperature distribution of the kicker in 300 seconds

As the runtime increases, the temperature of kicker also increases. When the temperature reaches a comparative high level, we should consider thermal radiation between the electrode and the inside surface of the barrel, other condition is the same as transient thermal calculation. When the process reaches steady state, we find the max value of temperature of the electrode is not more than 30°C, and water-cool is not necessary. The distribution difference of temperature will lead to deformation difference of the electrode, we can calculate deformation based on steady thermal result, and the max deformation calculated is 0.07mm, which is a small amount for mechanical structure. Figure 6 shows temperature distribution of electrode when steady state.

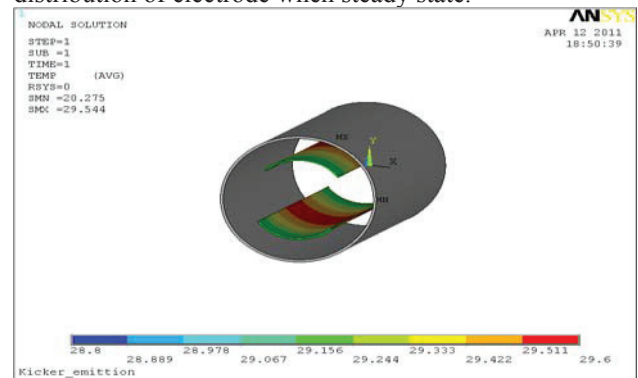

Figure 6: Temperature distribution of electrode when steady state.

### THE CHOICE OF LENGTH OF ELECTRODE AND TAPER

The length of electrode has impact on the exciting angle, and the longer the electrode is, the greater the

Copyright © 2012 by IEEE - cc Creative Commons Attribution 3.0 (CC BY 3.0) — cc Creative Commons Attribution 3.0 (CC BY 3.0)

impact is. The total length of kicker is not more than 1m, limited by the element arrangement of RCS. The length of taper is fixed, with increasing the length of electrode, we find the values of VSWR become larger monotonously. Similarly, the length of electrode is fixed and we find the longer the length of taper is, the larger VSWR is. There is difference in impact between the length of electrode and taper. With increasing the length of arc electrode from 680mm to 980mm, the length of taper shortens from 155mm to 5 mm in each side. When the length of the electrode is increased to 980mm, meanwhile the length of taper shortens to 5mm, VSWR is improved obviously, and it is helpful to improve the efficiency of power feeding, so the value 980mm is chosen as the length of the electrode for our kicker. Figure 7 shows VSWR results corresponding to different length of electrode and taper at 5MHz.

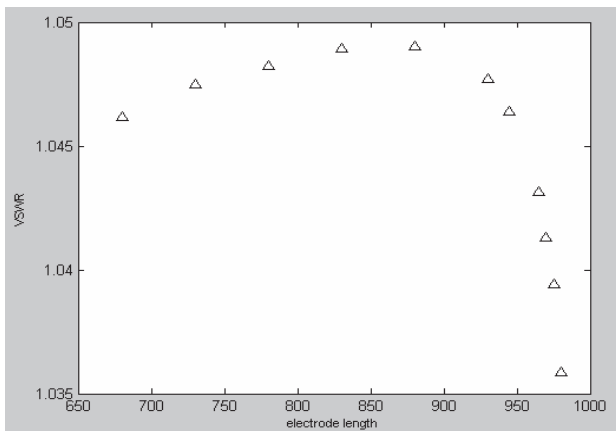

Figure 7: VSWR results corresponding to different length of electrode and taper at 5MHz.

### THE RESPONSE OF SINGLE PARTICLE

During tune measurement, the bunch is considered as a single particle. The bunch is excited and its turn-by-turn position in one BPM is measured. The exciting angle at  $n$ th turn in simulation is obtained from the following formulas.

$$\Delta x'_n = \theta_{rms} \sqrt{\frac{2}{N} \sum_{j=0}^{N-1} \cos \left[ 2\pi \frac{\Omega_j}{\omega_0} n + \phi_j \right]} \quad (1)$$

$$\theta_{rms} \approx \frac{eL}{pc} \left(1 + \frac{1}{\beta}\right) \frac{\sqrt{ZP}}{d} \quad (2)$$

$$\Omega_j = \Omega_0 + j \frac{\Delta\Omega}{N-1} \quad (3)$$

Where  $L$  is the length of the electrode (980mm),  $p$  is the momentum of the beam, here 1.6GeV is considered,  $\beta$  is the relativistic velocity,  $P$  is the total power(2000W),  $d$  is the distance between two electrodes (170mm),  $\omega_0$  is cyclotron angular frequency,  $\Omega_0$  is the lower limit of frequency of white noise,  $\Delta\Omega$

is the bandwidth of white noise, and  $\phi_j$  is the phase at  $j$ th exciting, here  $\phi$  distributes randomly in the range of  $2\pi$ . Figure 8 shows the envelope of turn-by-turn position in the BPM during exciting of the kicker when each piece of electrode fed with white noise 1000W in the MATLAB environment.

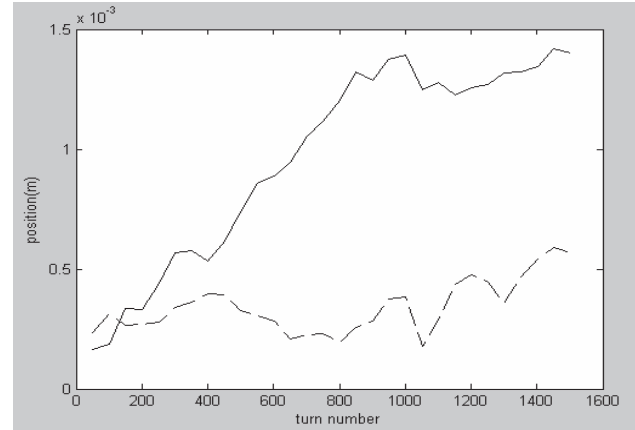

Figure 8: The envelope of turn-by-turn position in the BPM during exciting of kicker.

For  $\phi$  distributes randomly in the range of  $2\pi$ , it means white noise may play a part in excitation this time but may play a part in suppression next time, so the exciting effect depends on the state of random phase during the exciting process. It also means sometimes the bunch can be excited for tune measurement but sometimes may not.

### CONCLUSIONS

The technical design and parameter analysis of the strip-line kicker in CSNS RCS is presented. Three designs are compared and arc electrode kicker is chosen as our first design for its compact structure and superiority of wake impedance. Still some details and machining issues will be discussed later, and we will adopt appropriate solution according to requirement in practice.

### REFERENCES

- [1] WEI J, FANG S X, FENG J et al. "China Spallation Neutron Sources Design". In: Proceedings APAC 2007, Indore(2007)
- [2] A. Terebilo, "Accelerator Toolbox for MATLAB", SLAC-PUB-8732, May 2001
- [3] <http://www.mathworks.cn>
- [4] A.Ghigo, F.Marcellini et al. "Design of a Strip-line Extraction Kicker for CTF3 Combiner Ring", In: Proceedings EPAC 2006, Edinburgh(2006)
- [5] <http://www.cst.com>
- [6] <http://www.ansys.com>