

# Performance of Detectors Using Diamond Sensors at the LHC and CMS.



M. Hempel (DESY)

T. Baer, A. E. Dabrowski (CERN), W. Lohmann, W. Lange (DESY), N. J. Odell (Northwestern University), D. P. Stickland (Princeton University) E. Griesmayer (TU Wien)

## Abstract

Diamond detectors are used as beam loss and luminosity monitors for CMS and LHC. A time resolution in the nanosecond range allows to detect beam losses and luminosities of single bunches. The radiation hardness and negligible temperature dependence allow the usage of diamond sensors in high radiation fields without cooling. Two different diamond detector types are installed at LHC and CMS. One is based on pCVD diamonds and installed at different locations in the LHC tunnel for beam loss monitoring. Measurements of these detectors are used to perform a bunch-by-bunch beam loss analysis. They allow to disentangle the origin of beam losses. The second type uses sCVD diamonds and is located inside CMS for van-der-Meer scan, beam halo and online luminosity monitoring and around the LHC tunnel for beam loss observation. Results on the performance of these detectors will be presented and examples of the use for analyzing the beam conditions will be given. In order to persist the enhanced requirements of the LHC after the long shutdown, e.g. higher luminosity, an upgrade of the detectors is required. The concept of the new detectors will be presented and first results will be shown.

## Diamond Detectors Based on scCVD

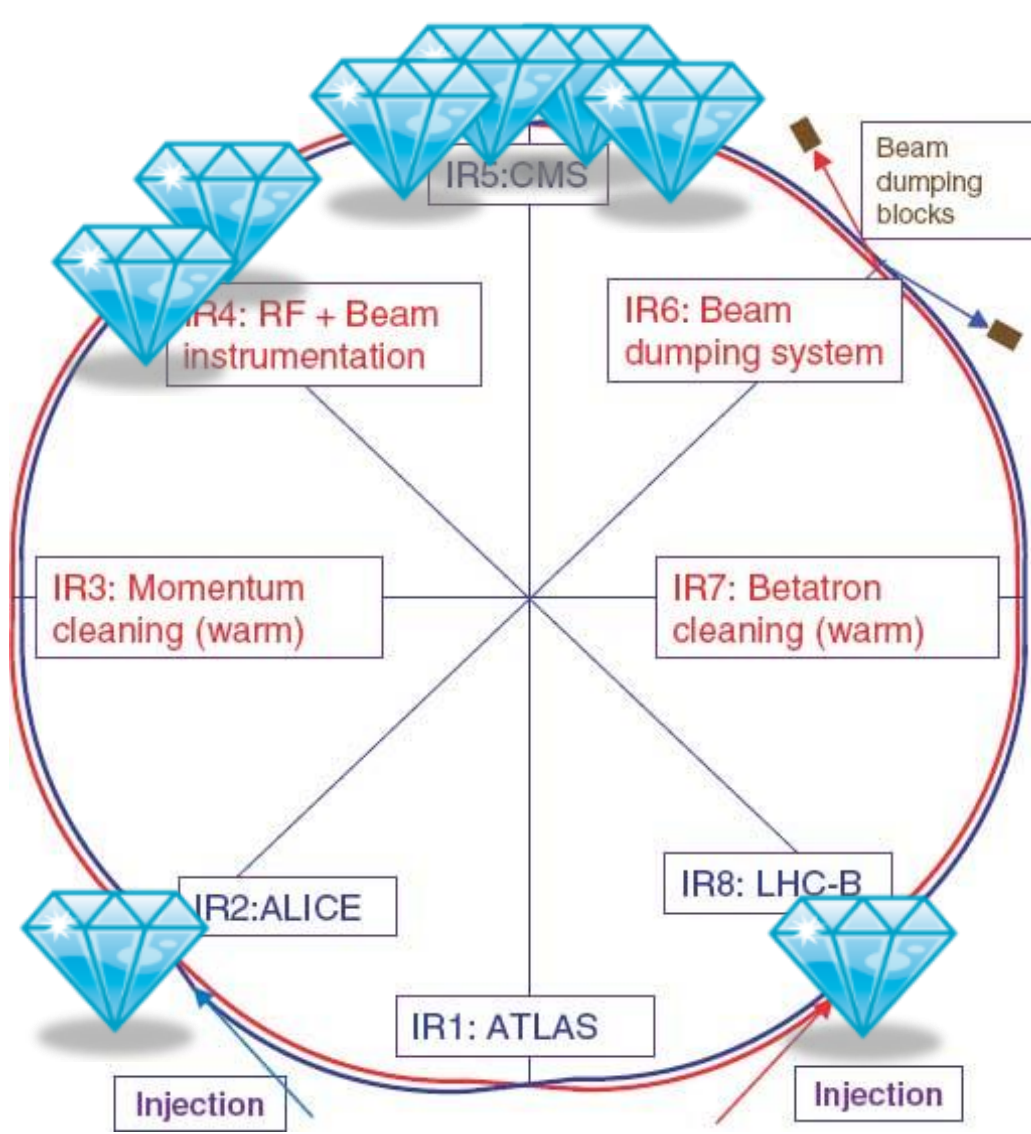

**scCVD Diamond Position around the LHC**  
Diamond detectors based on scCVD diamond sensors are installed around the LHC ring. Eight are located inside CMS (Fast Beam Condition Monitor BCM1F) for luminosity and beam halo measurements and six are around the LHC ring for beam loss observation.

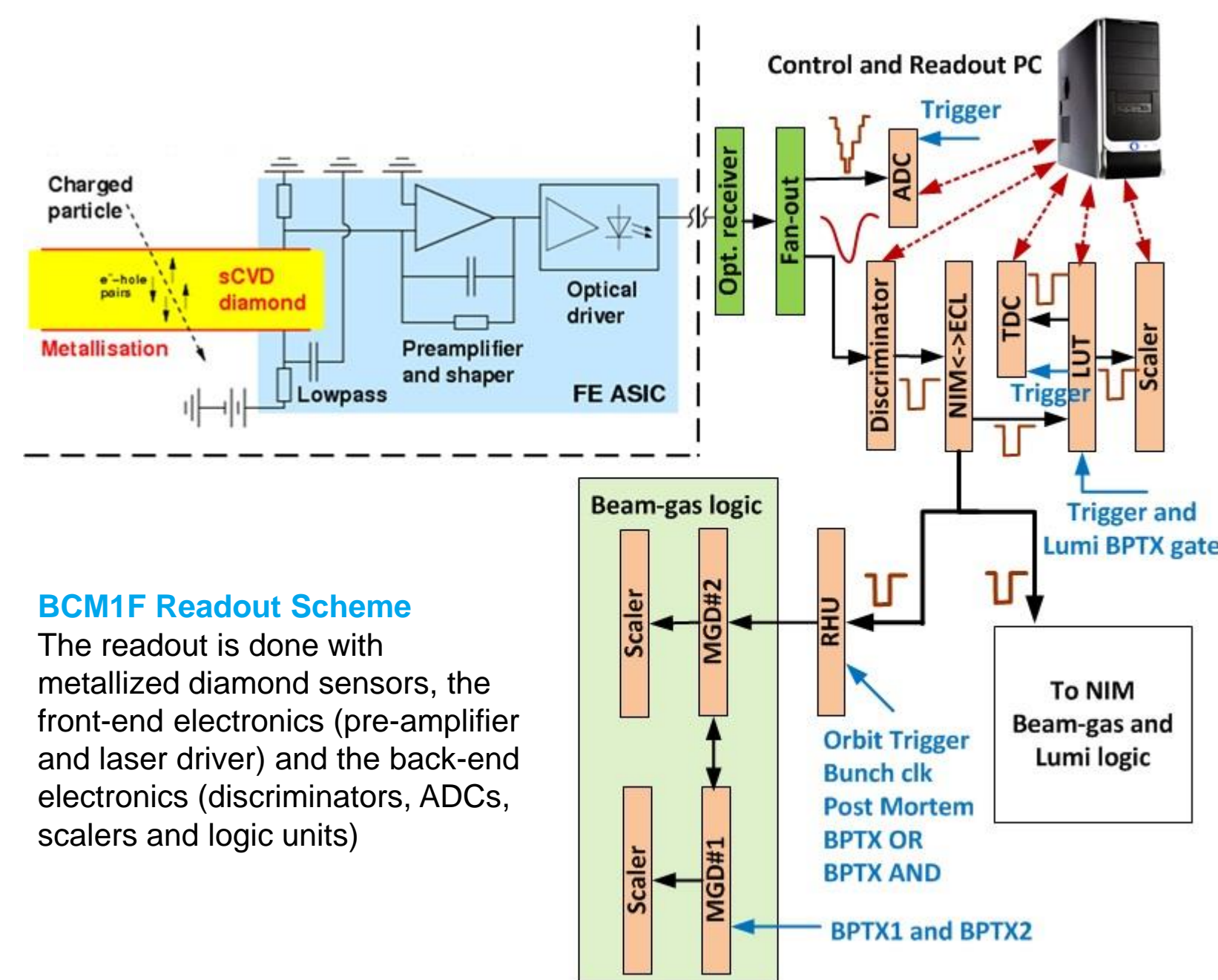

**BCM1F Readout Scheme**  
The readout is done with metallized diamond sensors, the front-end electronics (pre-amplifier and laser driver) and the back-end electronics (discriminators, ADCs, scalars and logic units)

## Diamond Detector Based on pcCVD

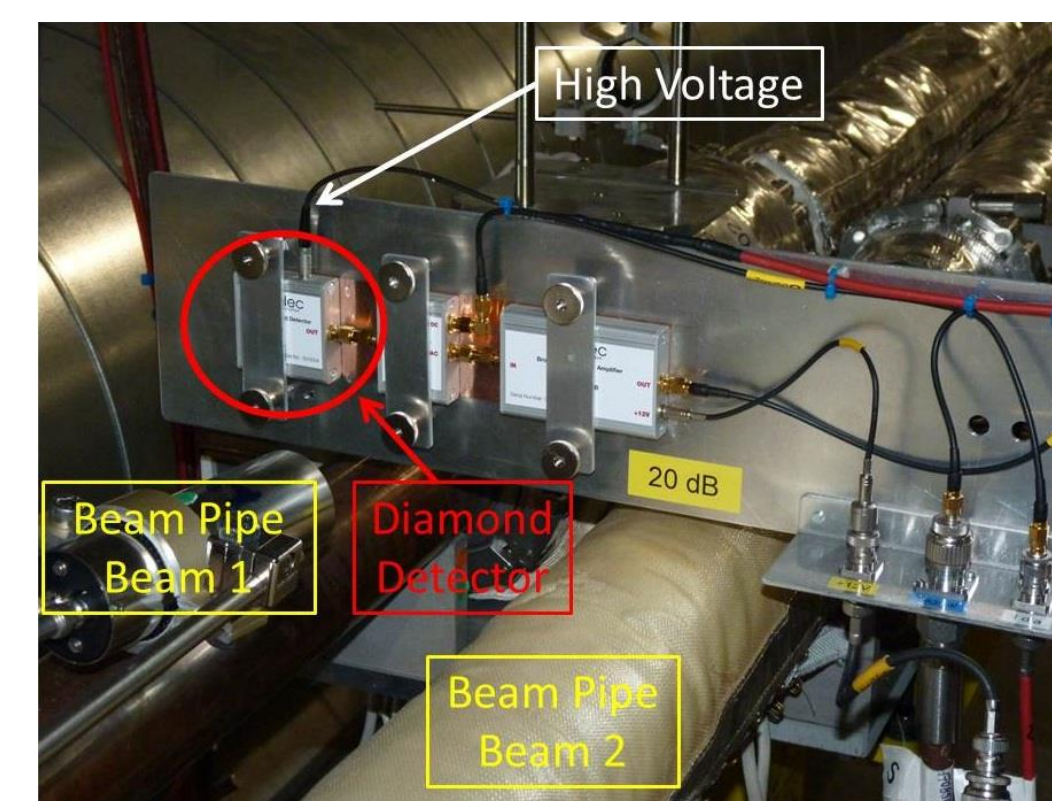

**Installation of Diamond Detectors**  
Installation of pcCVD diamond detector above the beam pipe for beam loss measurements.

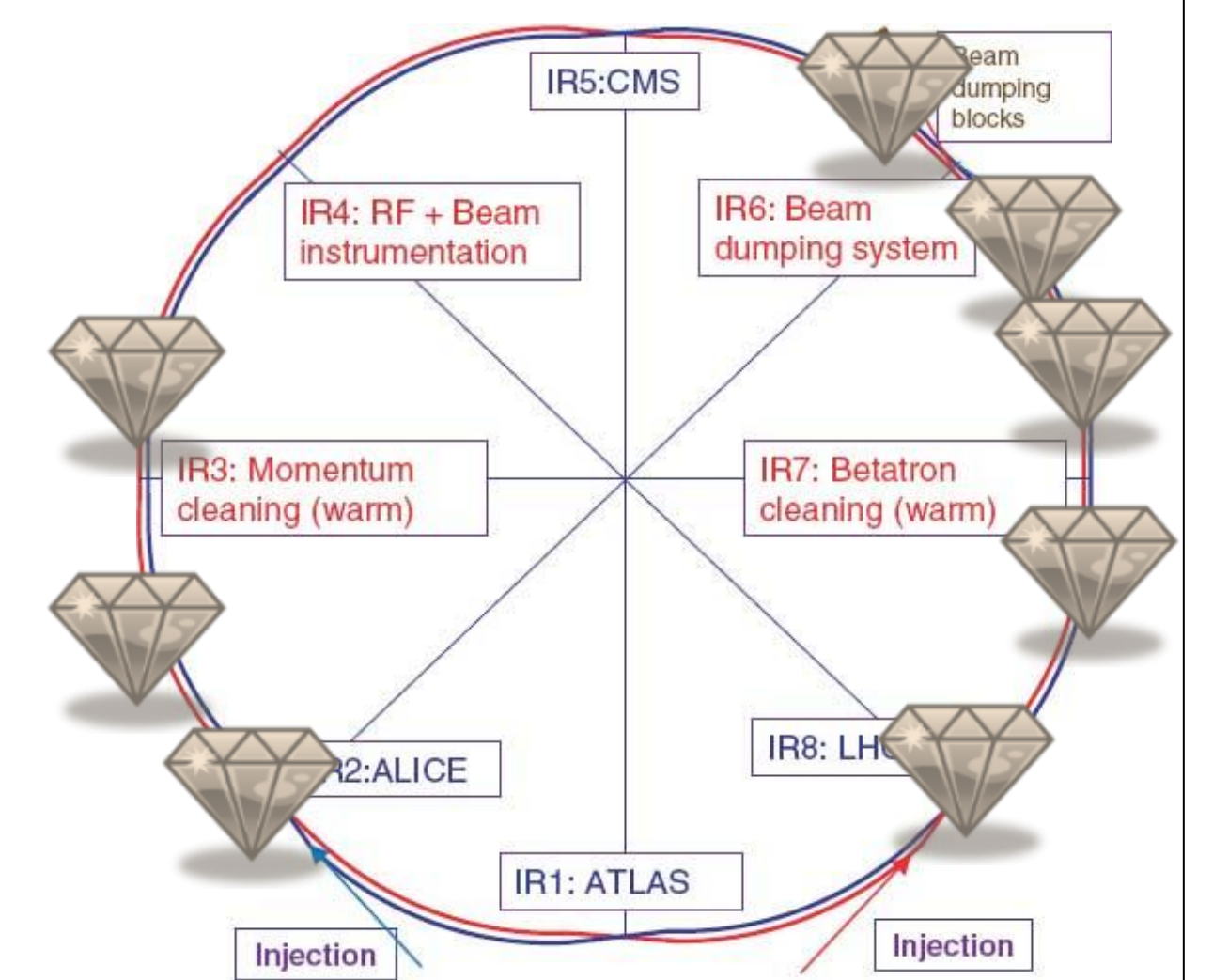

**pcCVD Diamond Detectors around the LHC Ring**  
pcCVD diamond detectors are installed around the beam pipe for beam loss measurements.

## scCVD Measurements

### Vacuum Observation with scCVD Sensors

Count rates from scCVD diamond installed near to LHCb as a function of time during collision in LHCb show an increase of rates can be observed due to additional residual gas interactions.

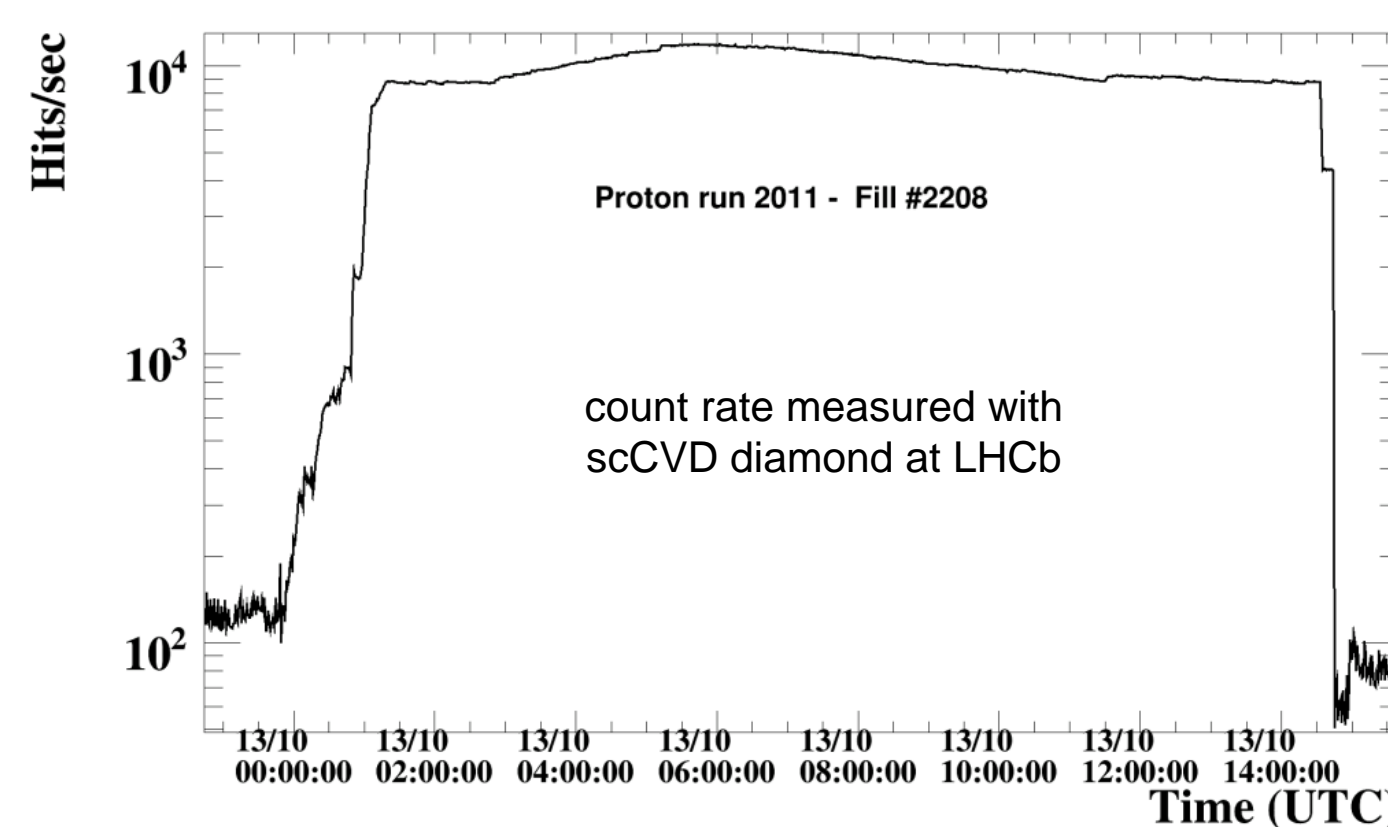

Luminosity and vacuum pressure measurement for LHCb as a function of time. The luminosity in LHCb is kept constant. An increase of vacuum pressure appears during the collision process.

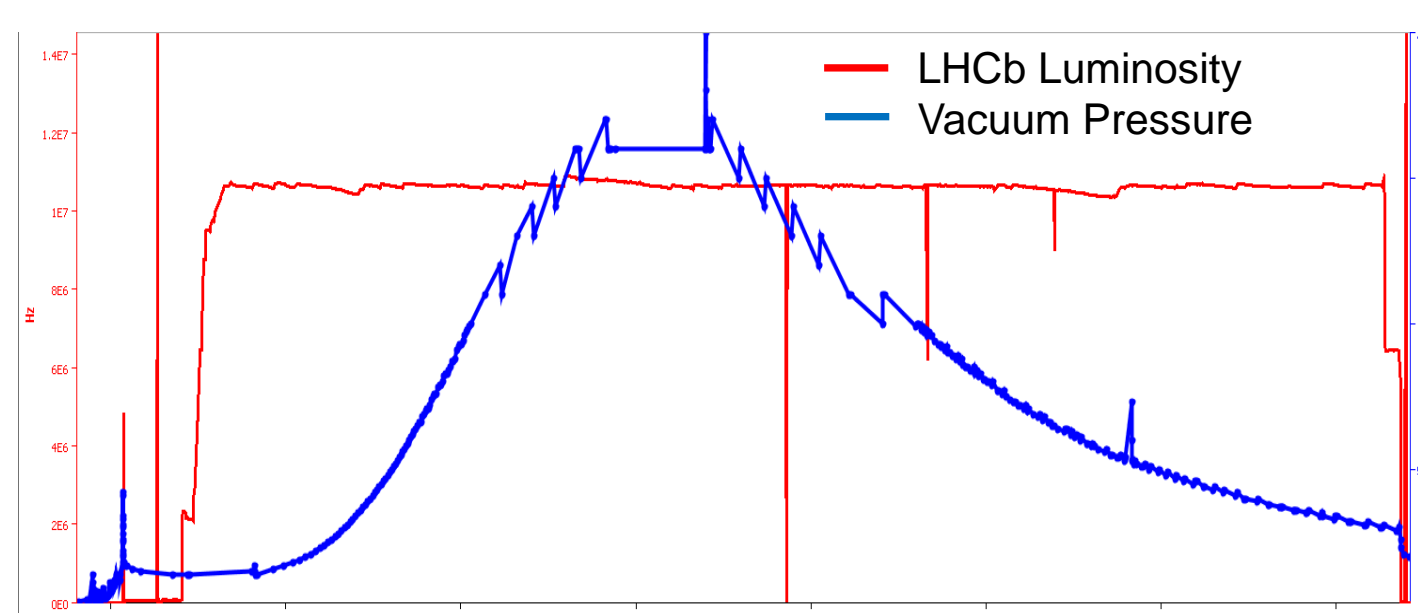

### Luminosity Measurements with scCVD Sensors

Luminosity is defined by:

$$L = \frac{f_b N_1 N_2}{2\pi \Sigma_x \Sigma_y}$$

$f_b$  orbit frequency  
 $N_{1/2}$  number of particles in bunches  
 $\Sigma_{x/y}$  horizontal and vertical beam width

The beam size is obtained with Van der Meer scans. The Figure shows the measured beam width over bunch crossing for the Hadron Forward Calorimeter HF and BCM1F. HF and BCM1F show good agreement

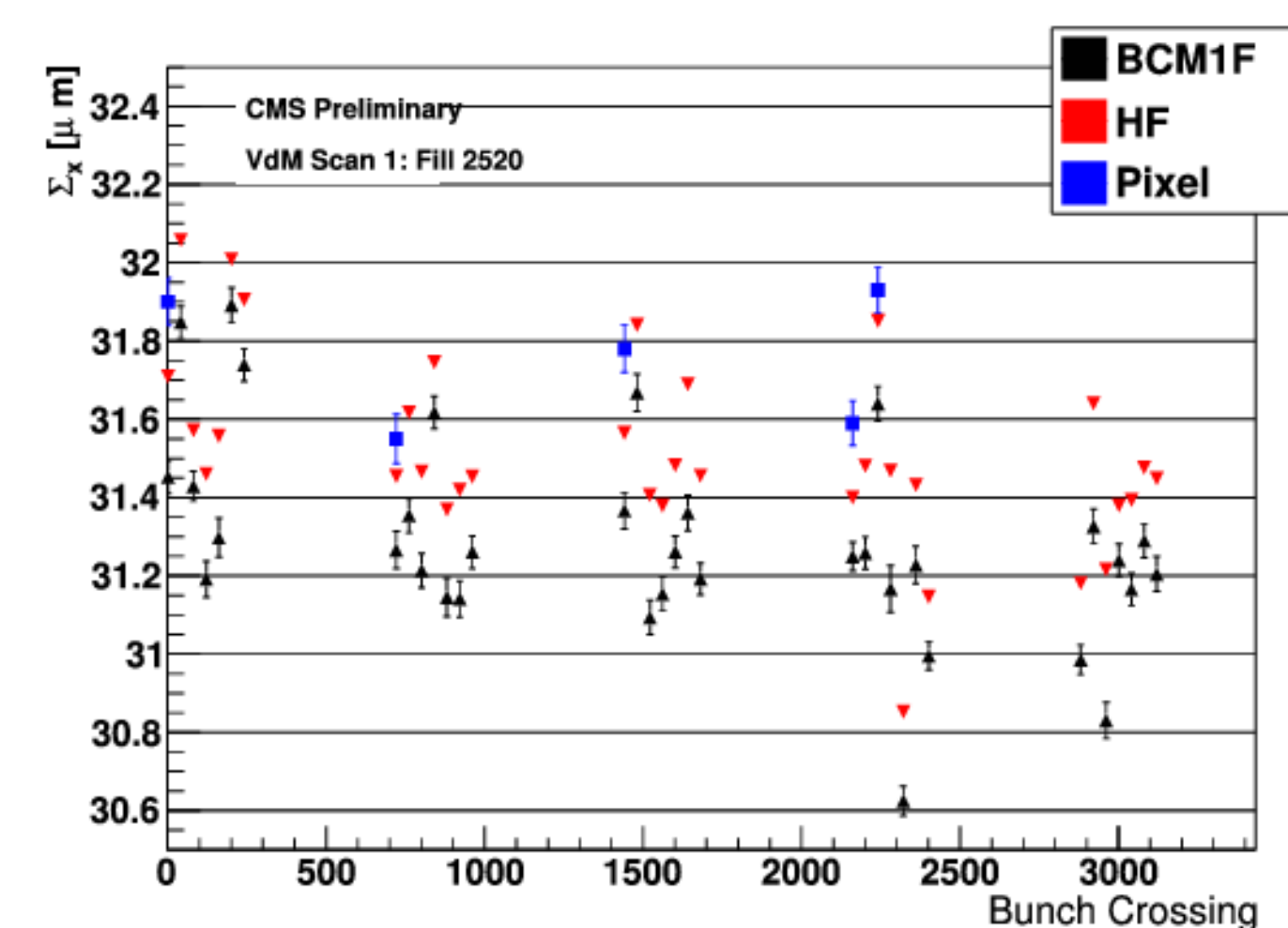

## pcCVD Measurements

### Beam Losses due to Injection Oscillations

Beam Losses as a function show an unbunched beam and 12 injected bunches due to injection oscillation. The unbunched is caused by the previously injected probe beam and the deflection of unbunched particles due to the rise time of the injection kicker magnet.

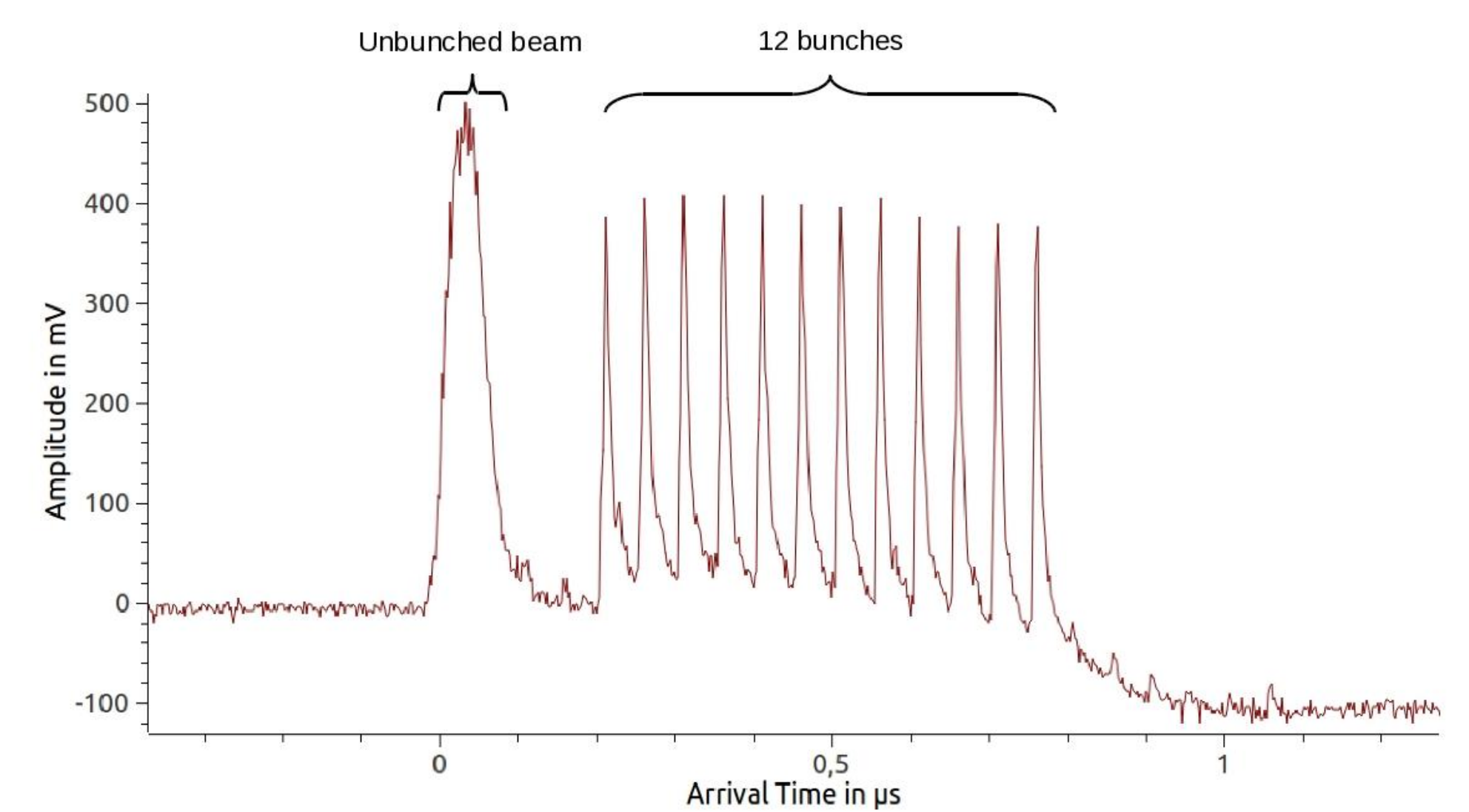

## BCM1F Signal Degradation

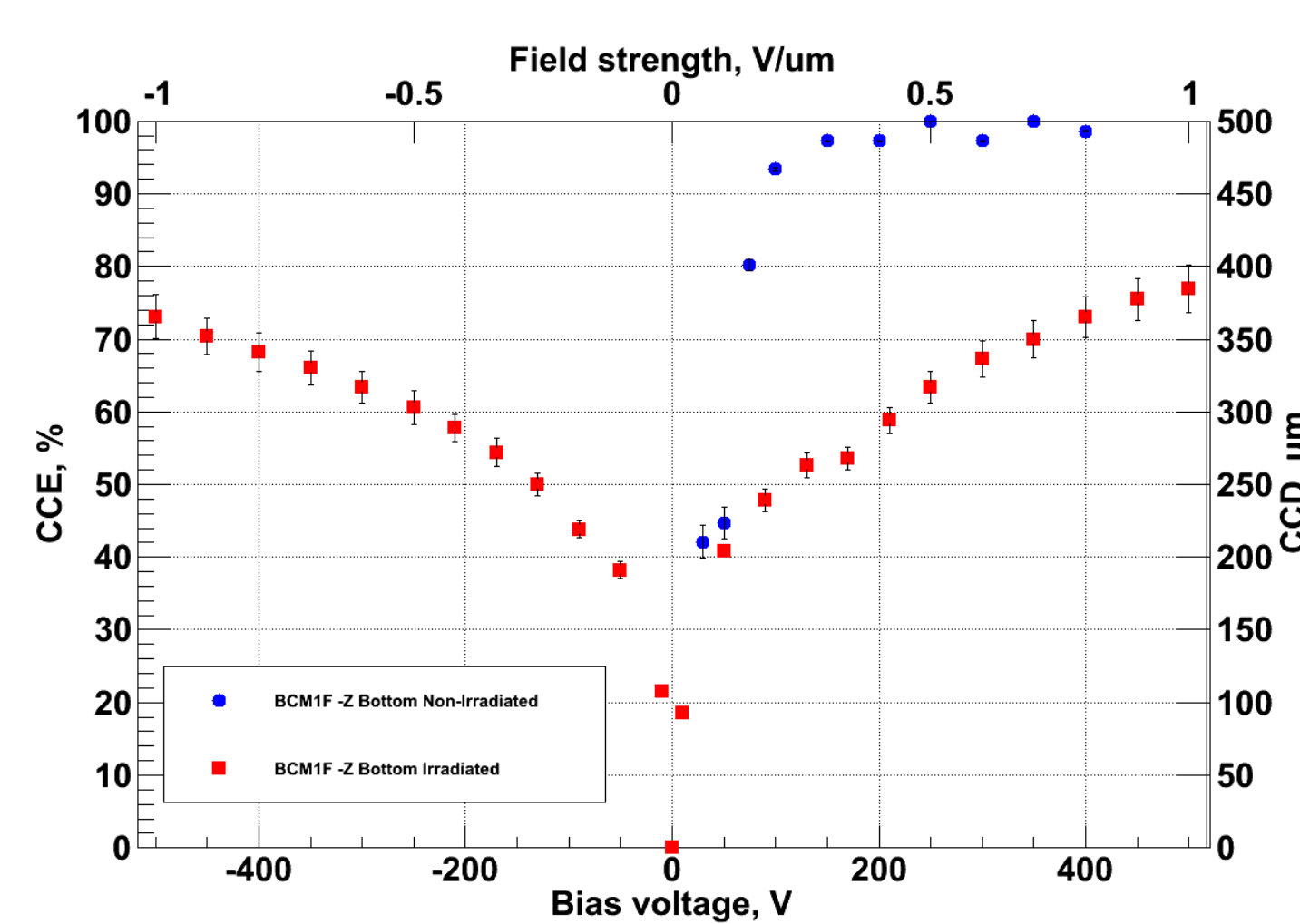

### Degradation of Charge Collection Efficiency

The charge collection efficiency of new scCVD diamonds is 100% with saturation at 100V(0.4V/μm). An irradiated scCVD diamond has a reduced charge collection efficiency to ~75% and no saturation.

## BCM1F Upgrade

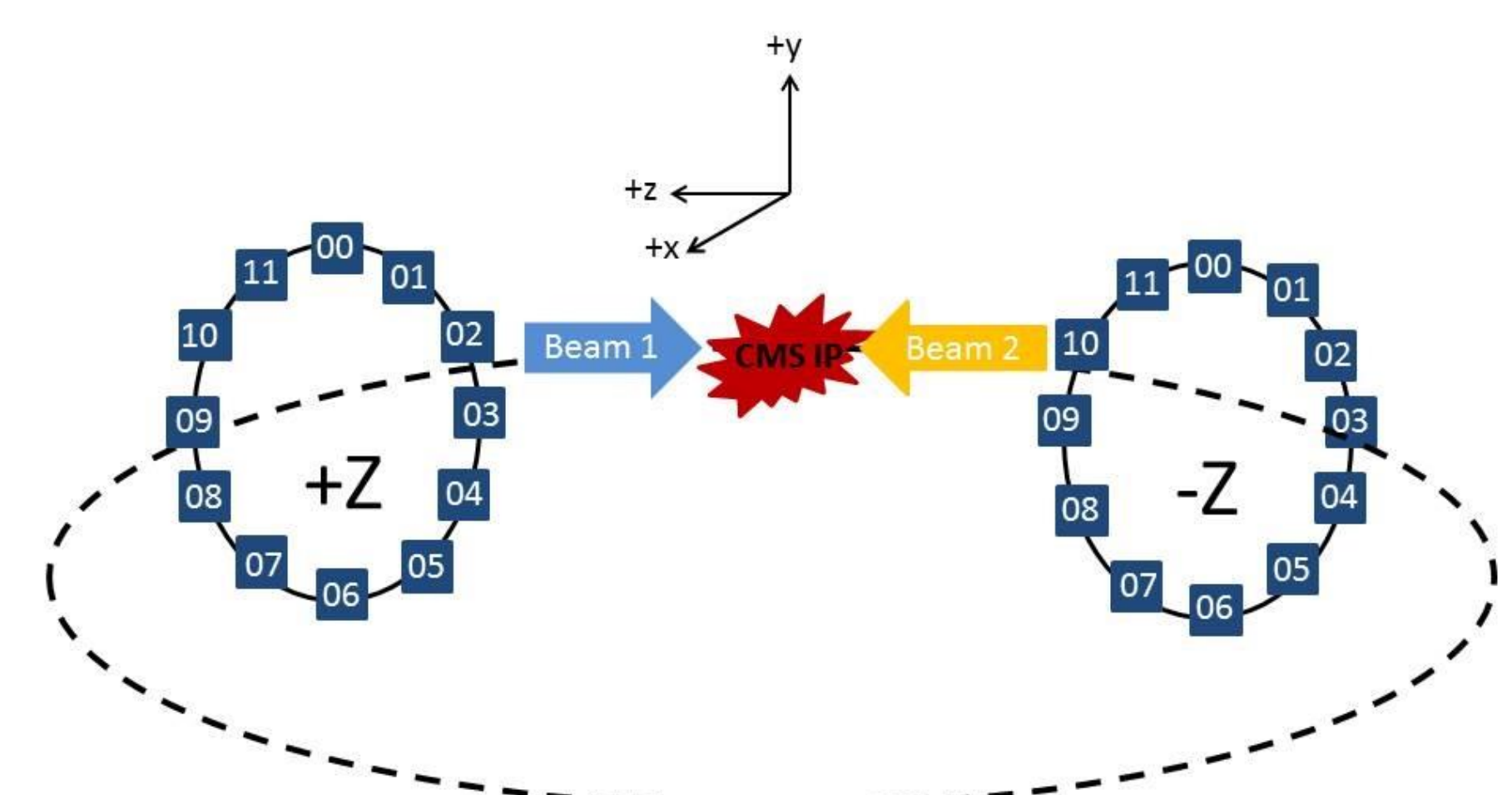

### Upgrade of Diamond Sensors

A new metallization of the BCM1F will be used and also the location scheme with an increased number of diamonds. 12 BCM1F diamonds around the beam pipe on each side of the CMS interaction point will be installed.

### Upgrade of Front-End Electronics

The amplifier will be upgraded to peaking time down to ~7ns, an amplification of ~50mV/fC and two MIPS separation with a separation of 12.5ns. The laser driver will be placed 16cm away from the CMS interaction point.

### Upgrade of Back-End Electronics

The basic modules are discriminators, scalars and fan-in-fan-out modules. Additional look up tables and real time histogramming units with programmable FPGA logic chips are used for luminosity measurements and beam halo counting.

