



Argonne
NATIONAL
LABORATORY

... for a brighter future



U.S. Department
of Energy

UChicago ►
Argonne_{LLC}



A U.S. Department of Energy laboratory
managed by UChicago Argonne, LLC

Commissioning of the ATLAS Energy Upgrade Cryomodule

Peter N. Ostroumov,

***Joel Fuerst, Scott Gerbick, Mark Kedzie,
Mike Kelly, Steve MacDonald, Richard
Pardo, Sergey Sharamentov, Ken Shepard,
Gary Zinkann***

**11th International Conference on
HEAVY ION ACCELERATOR TECHNOLOGY**

June 8-12, 2009

Content

- Goal of the project
 - New design of a low-beta cryomodule
 - ATLAS energy upgrade
- Cavity parameters
 - Steering compensation
 - EM properties are well optimized
- Cryomodule assembly
 - Surface processing
 - Clean-room assembly
- Off-line commissioning
 - Pumping out, leak check, cool-down
 - Cold tests
- RF system
- Installation
 - New solenoid, cold trap
 - Alignment

The goal

- QWRs are extended vertically: box cryomodules
- Originally developed for large scale production, FRIB
- Separation of the cavity vacuum space from the insulating vacuum
 - Similar to $\beta_G=1$ cavities in electron linacs: JLAB, ILC
- High performance
 - Optimized design of the cavities, EM, structural, Cancel the beam steering effect due to the RF field in the QWR
 - Surface processing, clean-room assembly, low-particulate pumping and venting system
- Top loaded cryomodule: minimize clean-room procedures
- Minimize distance between the cryomodules and provide space for beam diagnostics box
- Demonstrate average 27.5 MV/m peak surface field: design goal for ANL/FRIB
- Upgrade ATLAS beam energies
 - CARIBU beams, $q/A \approx 1/7$, $W = 10$ MeV/u

ATLAS Layout, May 28th 2009

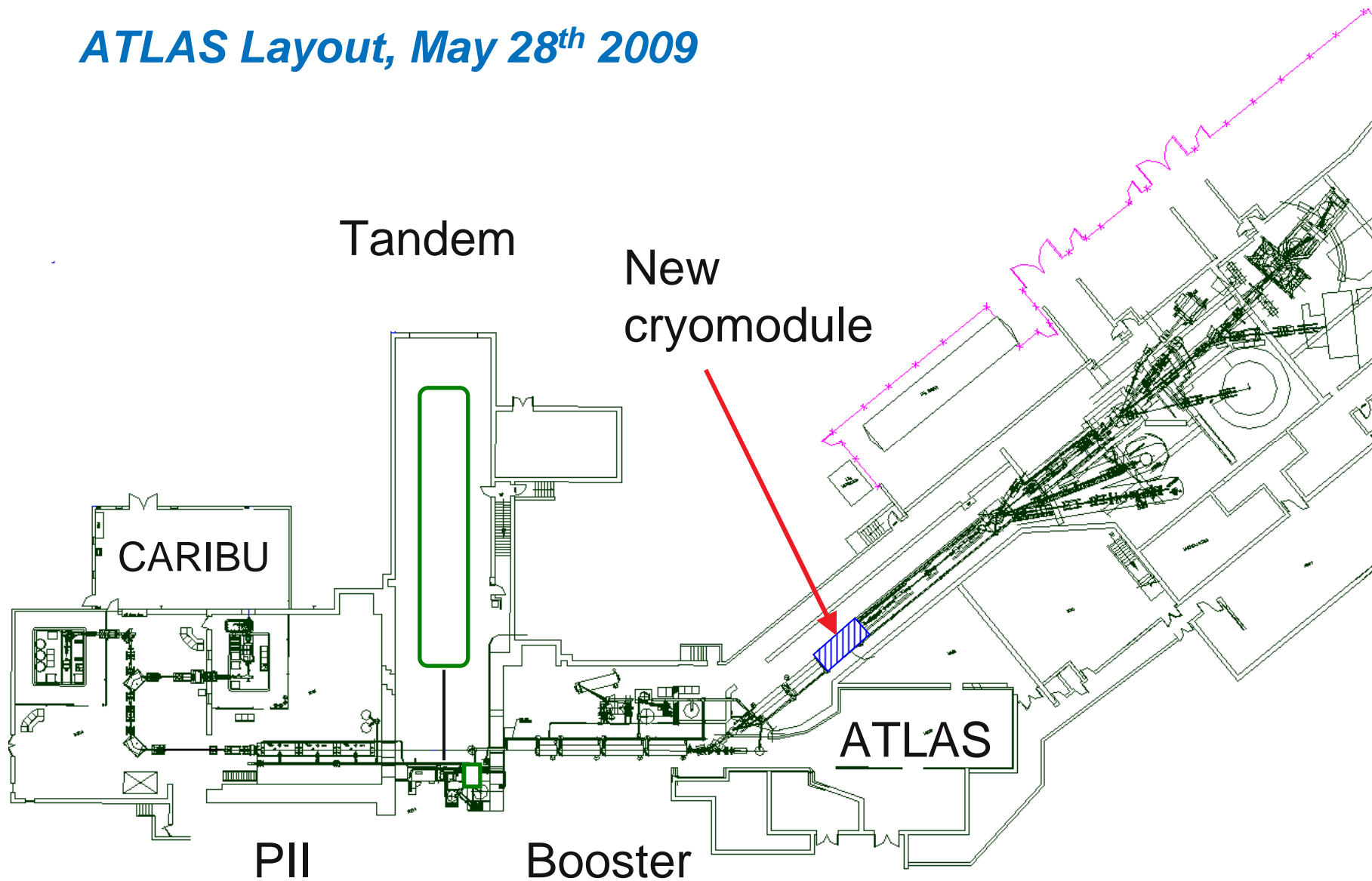

Compensation of the beam-steering effect

- (1) By cavity displacement in vertical plane: useful for heavy ions
- (2) By reshaping of the drift tubes: universal for all regimes

Beam tests will be available in 1-2 weeks from now

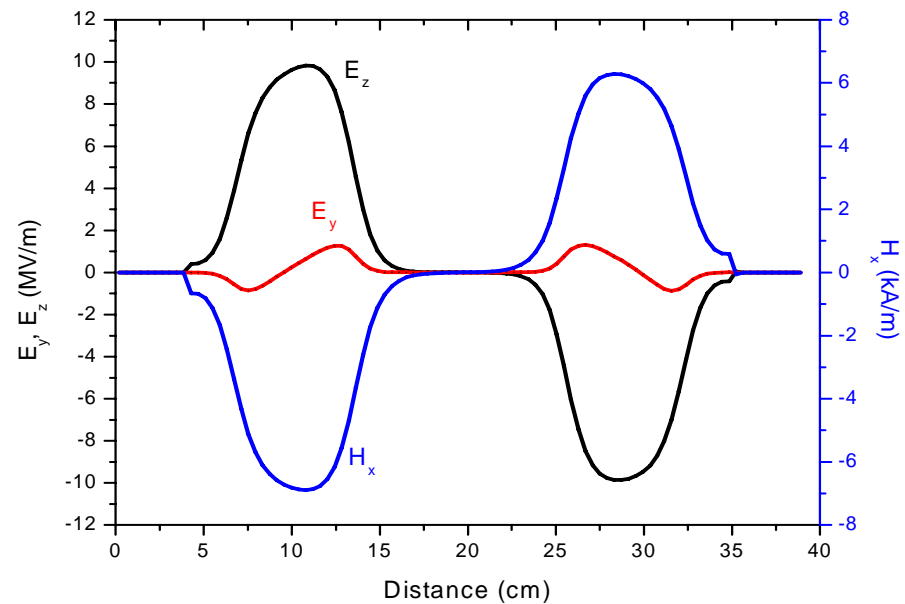
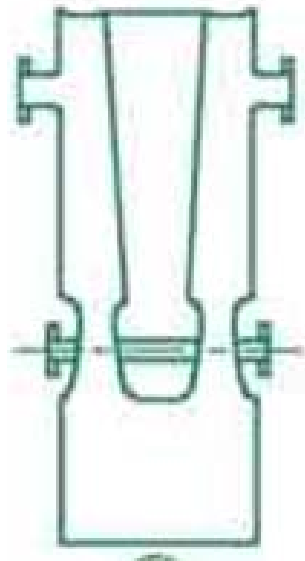
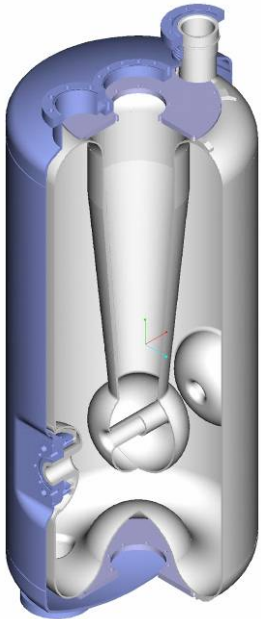

$^{58}\text{Ni}^{14+}$ beam parameters at the entrance of the last solenoid in the F-cryostat as measured recently

| Emittance (π mm mrad) | X | Y |
|----------------------------|-------|------|
| Normalized 1 rms | 0.065 | 0.11 |
| Normalized 90% | 0.2 | 0.47 |
| Un-normalized 90% | 2.1 | 4.8 |

| Twiss parameters | X | Y |
|------------------|------|------|
| Alpha | 0.06 | 2.79 |
| Beta | 0.53 | 2.04 |

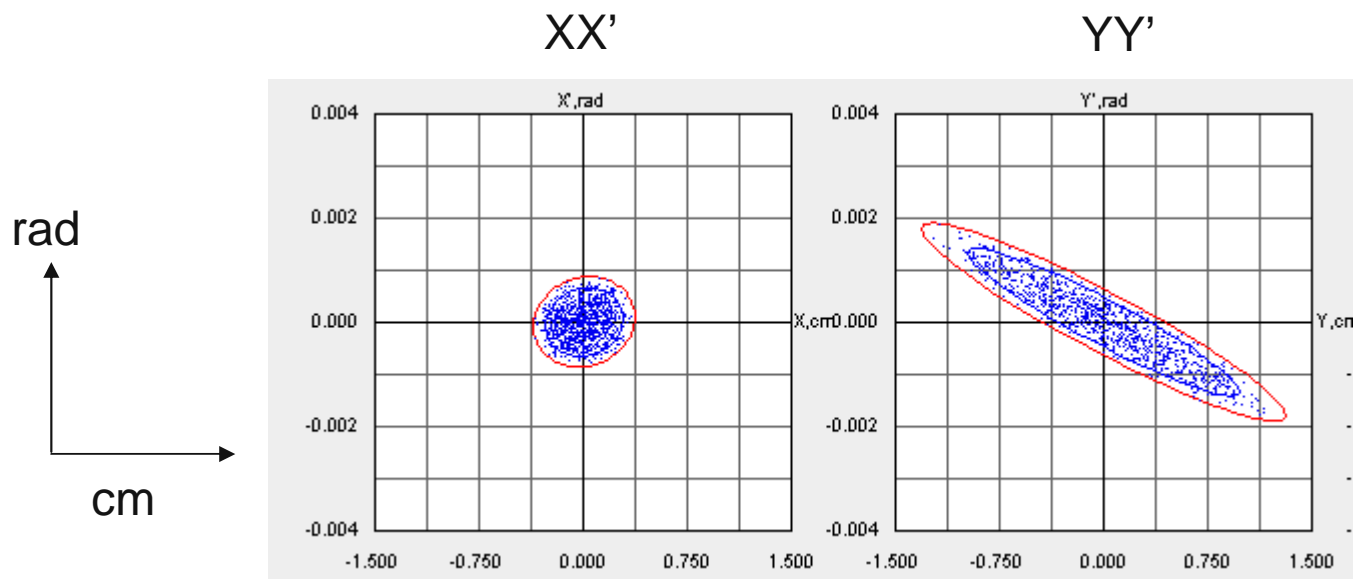

Uranium beam dynamics in the upgraded cryomodule

ATLAS UPGRADE

Win=6 MeV/u, B_sol_after "F" = 5.5 T

Jul 25, 2008, 11:05:58

Jul 25, 2008, 11:07:59

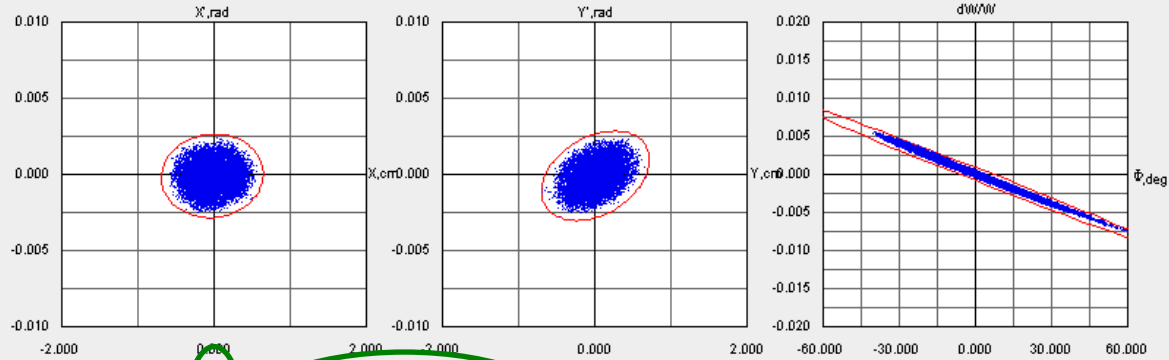

Freq= 109.125 MHz
 W= 8.062 MeV/u
 Q= 33
 A= 238
 Npart= 10001
 Current= 0.000 mA
 SPACE CHARGE
 Nx= 33 Ny= 33 Nz= 65 zlhSC=*****
 hx/sx= NaN hy/sy= NaN hz/sz= NaN

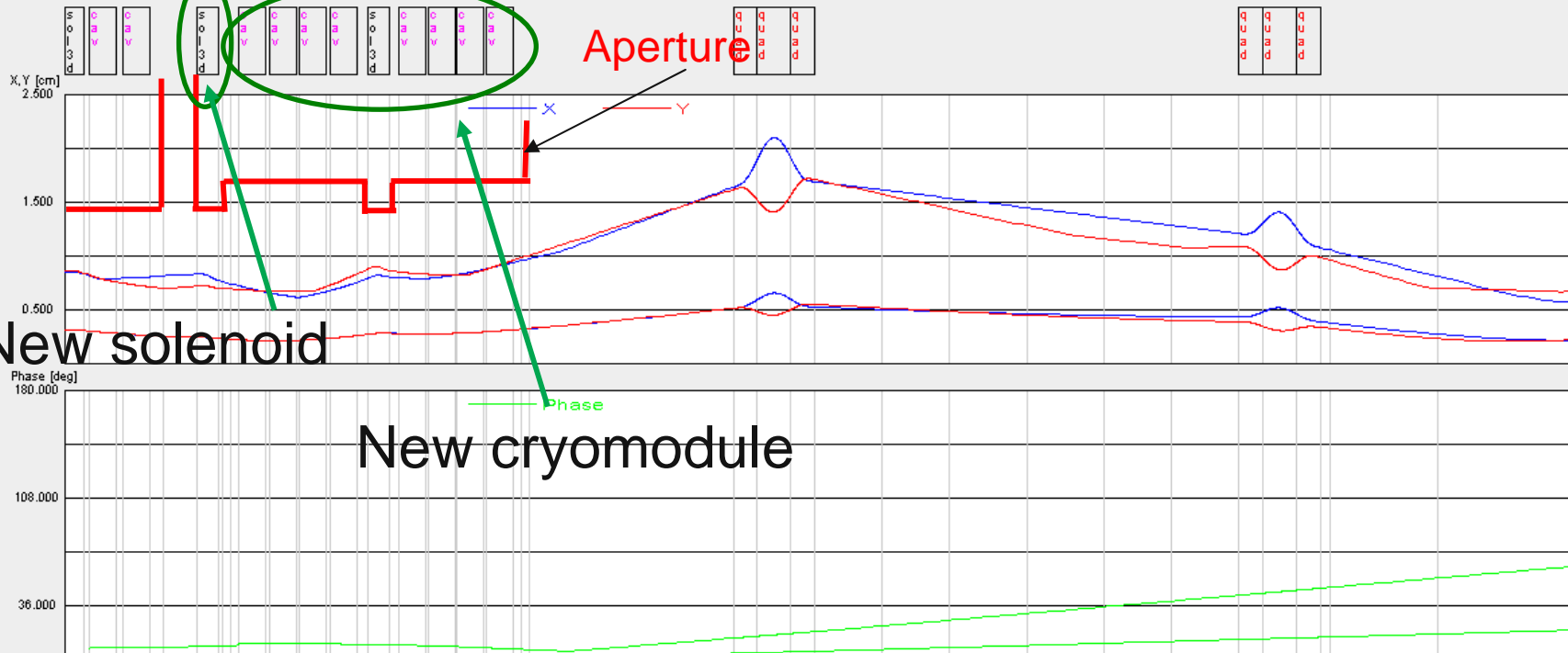

ATLAS beam energies with the upgrade cryomodule

- Average accelerating gradient, 9.4 MV/m, demonstrated with the VCX, routine operation is recommended at 8.45 MV/m, provides 14.8 MV, this is 27.0 MV/m peak surface field

| Ion | Q1 | W (MeV/u) | Q1/Q2 | W (MeV/u) |
|-------------------|----|-----------|-------|-----------|
| ^{12}C | 4 | 19.3 | 4/6 | 23.9 |
| ^{16}O | 6 | 20.9 | 6/8 | 24.3 |
| ^{28}Si | 9 | 18.8 | 7/14 | 23.1 |
| ^{50}Ti | 13 | 16.2 | 12/21 | 20.8 |
| ^{64}Ni | 14 | 14.3 | 14/25 | 19.7 |
| ^{84}Kr | 15 | 12.2 | 15/31 | 18.5 |
| ^{92}Mo | 21 | 14.7 | 21/34 | 19.2 |
| ^{127}Xe | 25 | 13.2 | 25/40 | 17.1 |
| ^{178}Hf | 31 | 12.0 | 31/50 | 15.7 |
| ^{208}Pb | 36 | 11.9 | 36/55 | 15.1 |
| ^{238}U | 34 | 10.0 | | |

Top-loaded cryostat

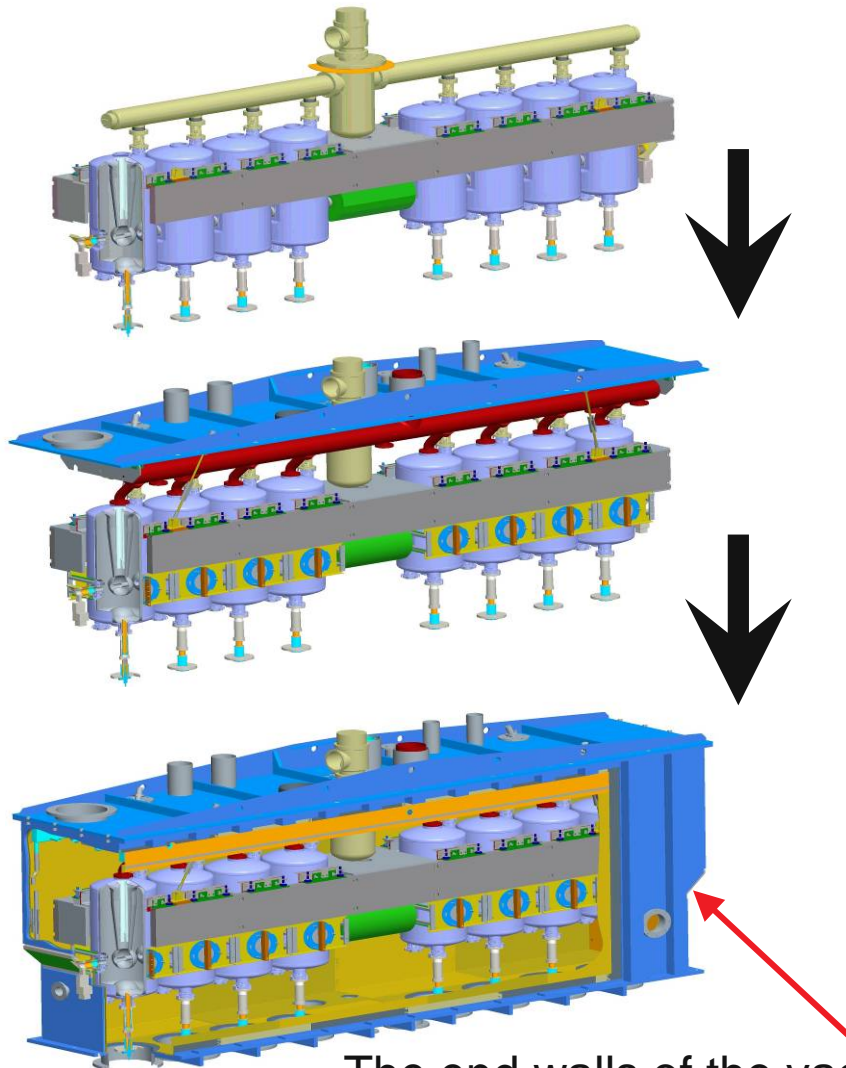

- a) Space-efficient
- b) Consistent with the requirements for high performance SRF surfaces.

Module-to-module spacing

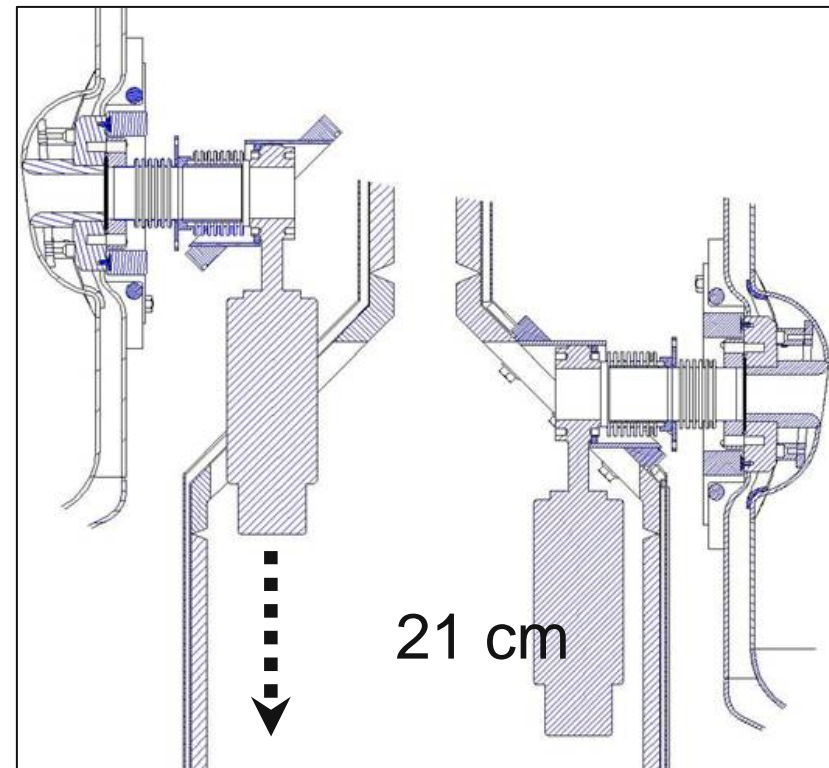

The end walls of the vacuum vessel are chamfered in the middle

Main design parameters of the SC cavities

Cavity Parameters

| | | 1 MV/m | 15 MV/m | |
|------------------|---------|--------|---------|------|
| Frequency | 109.125 | | | MHz |
| beta | 0.14 | | | |
| U_0 | | 0.17 | 37.40 | J |
| length | 25.00 | | | cm |
| $\beta\lambda/2$ | 39.05 | | | cm |
| E_{PEAK} | | 3.20 | 48.00 | MV/m |
| B_{PEAK} | | 58.30 | 874.50 | G |
| G | 39.90 | | | Ohm |
| R_{sh}/Q | 547.49 | | | Ohm |

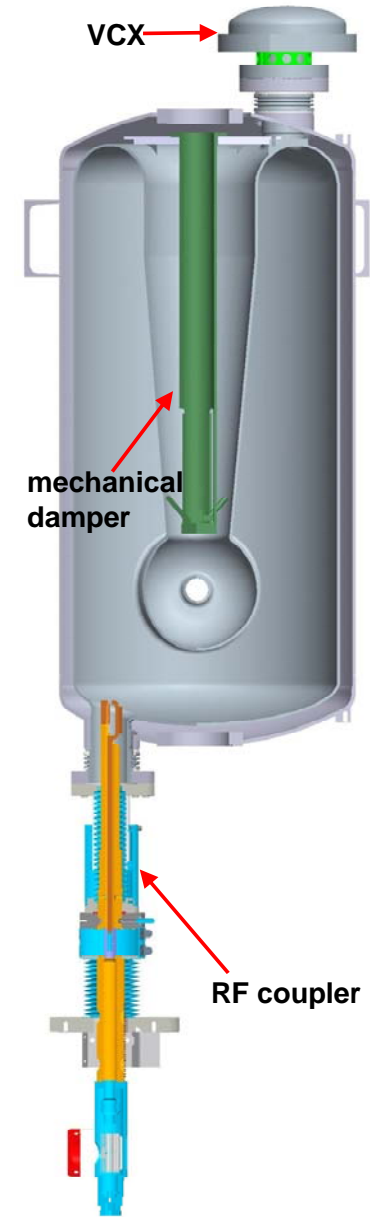

Cavity surface processing

- Electropolishing of fully assembled cavities
- Light BCP after final welding of the end plate
- HPWR



Cavity and its sub-systems

- Designed for negligible beam loading: requires ~ 60 W RF amplifier to operate, critically coupled to $\sim 2 \times 10^8$ which is an intrinsic Q_0 with VCX
- Requires fast tuner which is VCX



The cavity string assembly in the clean area (between class 10 and 100) is complete, including complete, sealed cavity vacuum system



Cavity string suspended from the lid, with all cryogenic plumbing assembled and leak-checked, ready to drop into the box vacuum vessel



Cryomodule cool-down (total 38 temperature sensor)

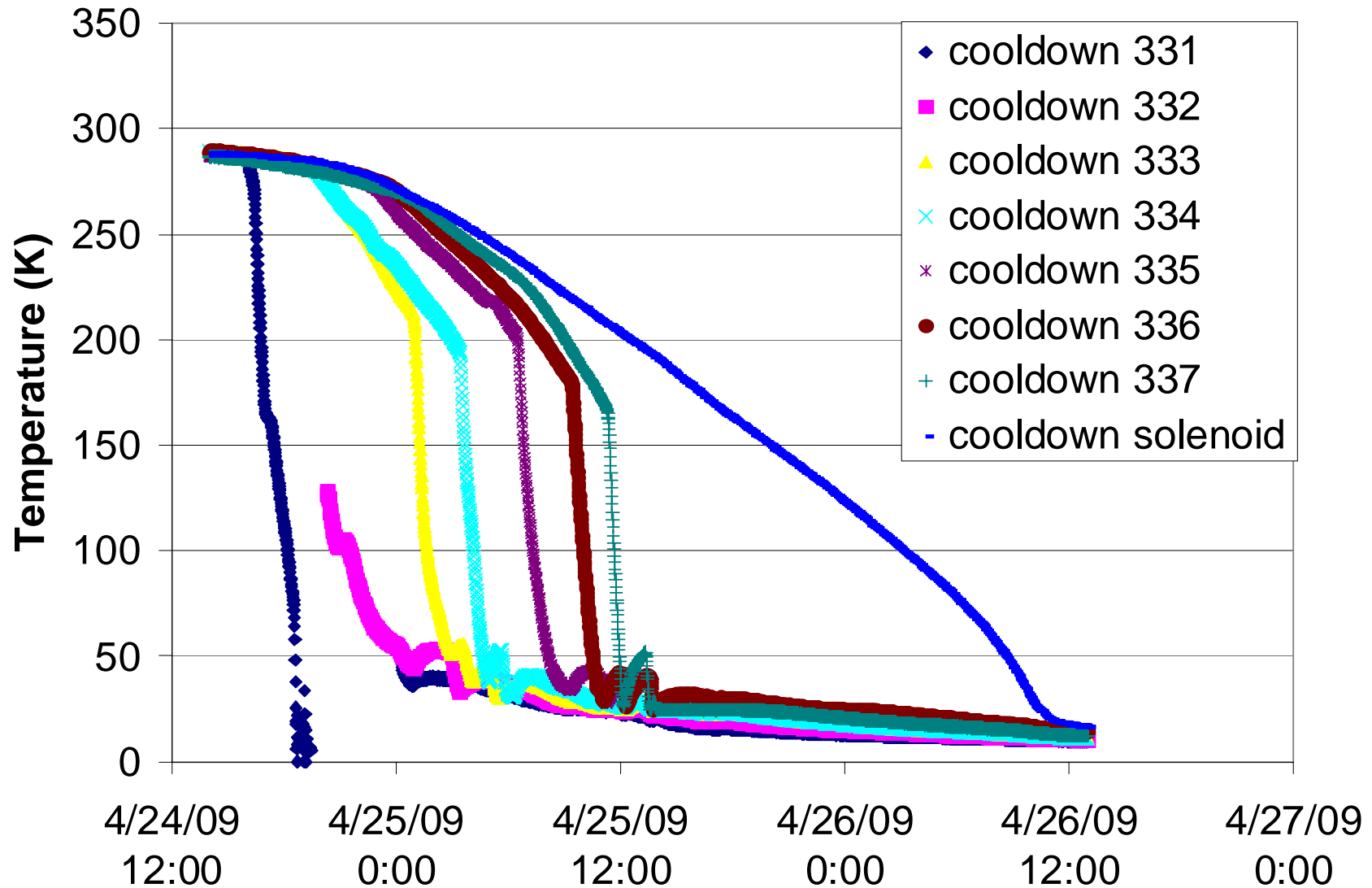

Accelerating fields

- Maximum in 2 cavities = 15 MV/m
 - $V_{MAX}=3.75$ MV, $E_{PEAK}= 48$ MV/m $B_{PEAK}= 875$ Gauss
- Limited by VCX = 9.4 MV/m, averaged over 7 cavities
 - Large stored energy, tuning window is fixed, reactive power ~27 KVA
- Recommended for routine operation = 8.4 MV/m

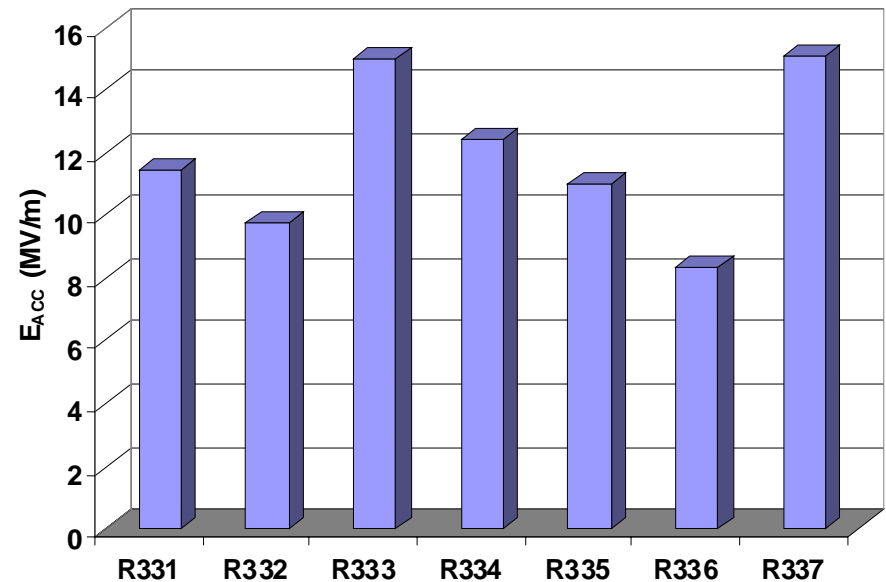
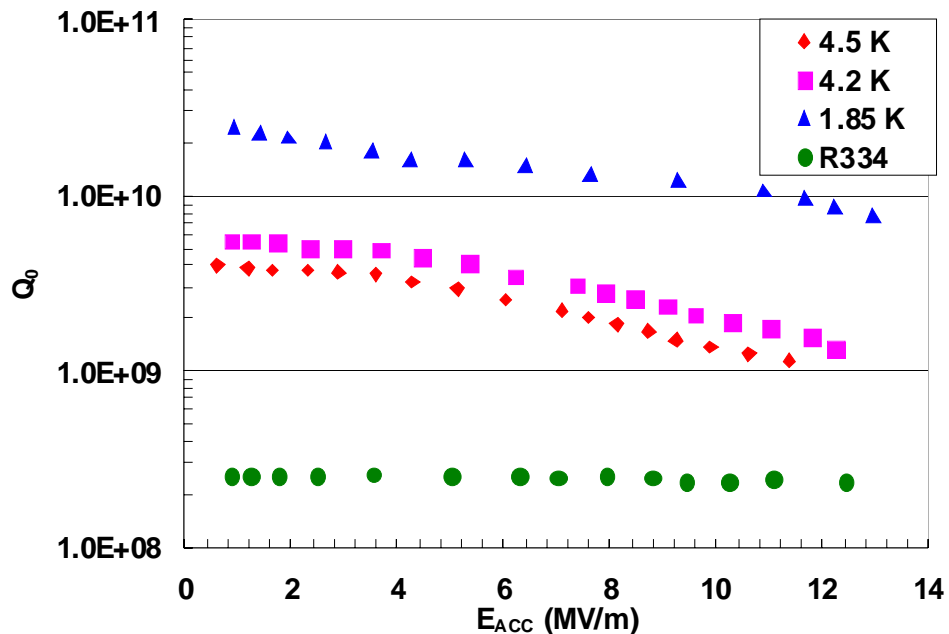

RF system

- 250 W solid-state water-cooled amplifiers
- I&Q type LLRF controller has the following feedback loops
 - Frequency – use slow tuner
 - Amplitude – adjust input drive power
 - Phase - use VCX
- Slow and Fast tuner controllers
- In addition, voltage pulsers are used to open-close VCX diodes

RF system

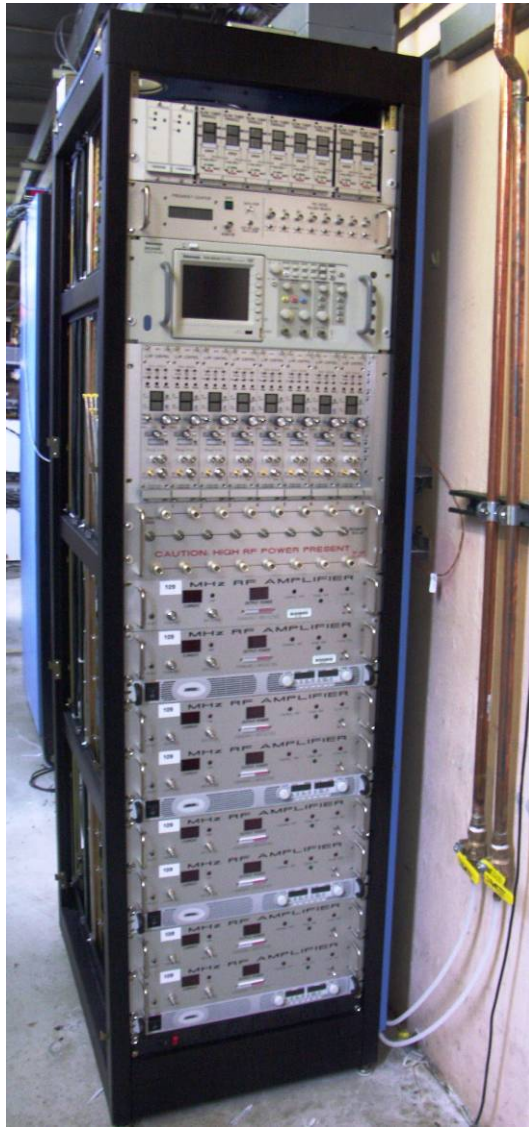

ATLAS Energy Upgrade Cryomodule in the tunnel

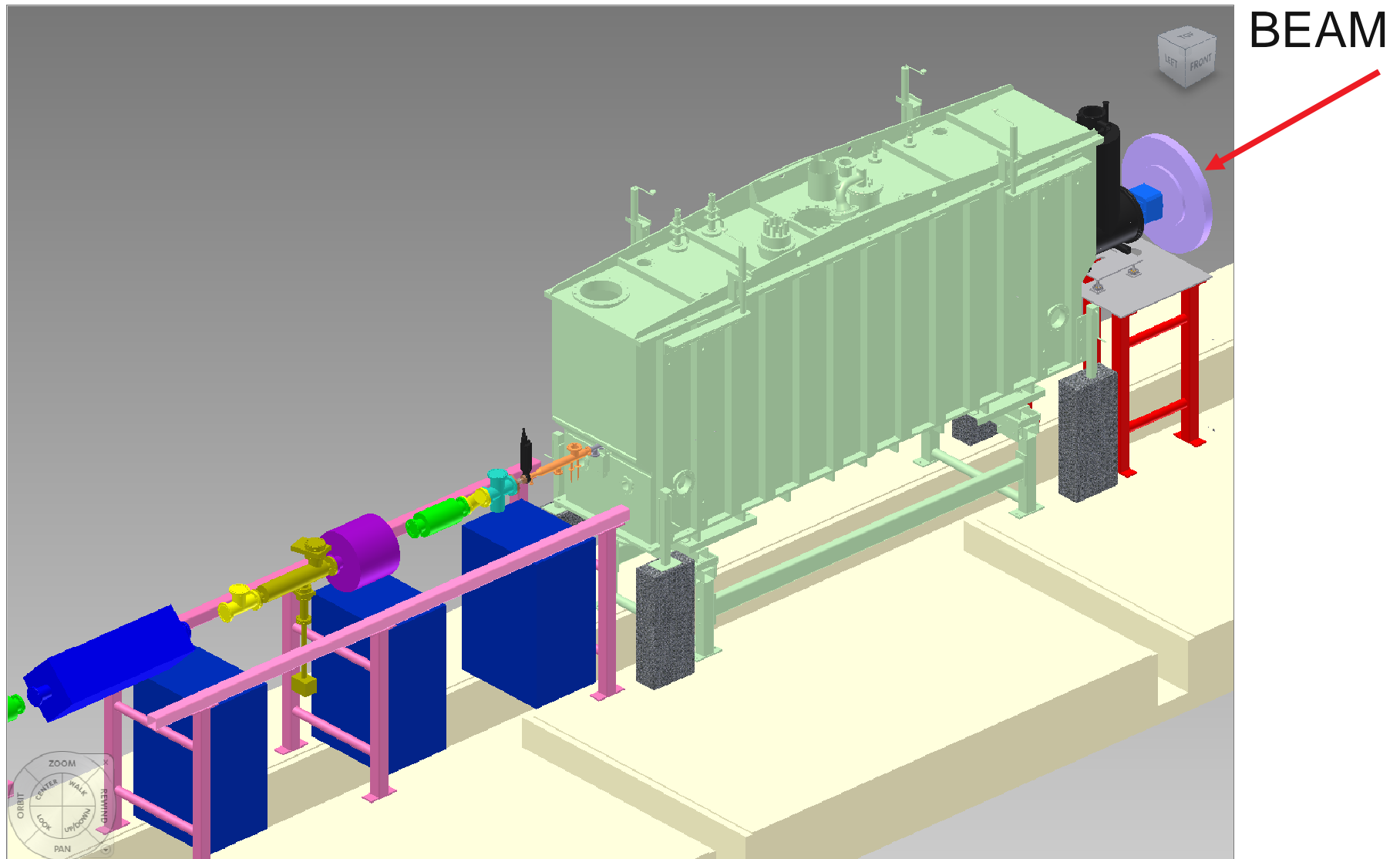

Installation: cryomodule, 9-Tesla solenoid, LN trap

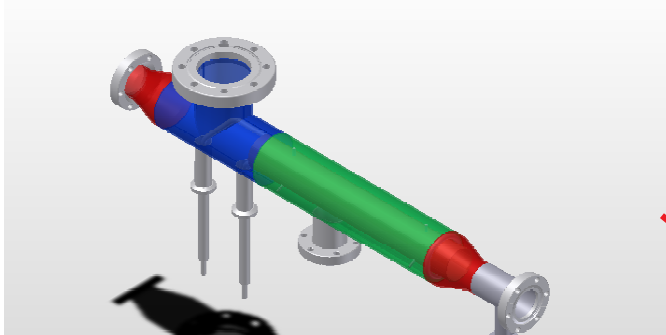

Alignment

- Box, lid and strongback have been fiducialized
- Special fixtures are used to transfer aperture centers to the resonator fiducial points
- Optical tooling instruments are used outside the clean room
- Initial alignment: ± 0.1 mm
- Vertical movement of the targets in the cryostat due to cool-down: 1.5 mm
- Overall installation alignment in the tunnel: ± 0.5 mm
- Viewing ports
- Limited time for alignment work due to the schedule
- Check with beam

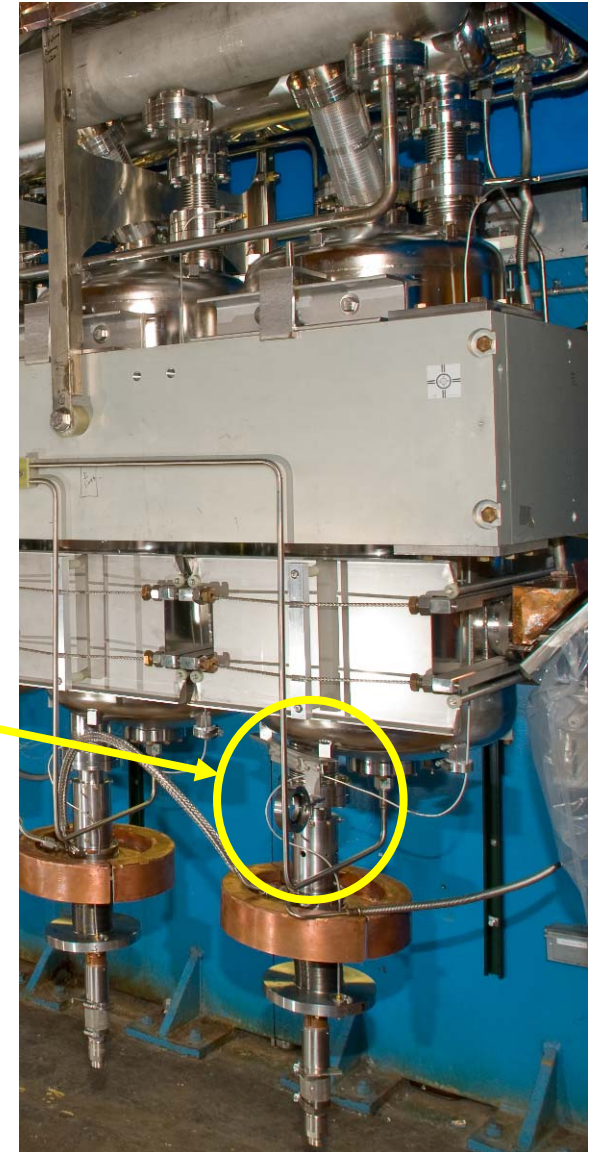

Summary

- All R&D design concepts were successfully demonstrated
- After short RF conditioning average performance of 7 cavities is better than in the test cryostat
- Routine operation of cavities
 - $V_0=2.11$ MV per cavity, or $E_{\text{PEAK}}= 27.0$ MV/m $B_{\text{PEAK}}= 492$ Gauss
- Without VCX could provide (different type of fast tuners are required)
 - Maximum $V_{\text{MAX}}=3.75$ MV, $E_{\text{PEAK}}= 48$ MV/m $B_{\text{PEAK}}= 875$ Gauss
 - Average $V_{\text{MAX}}= 2.35$ MV, $E_{\text{PEAK}}= 30$ MV/m $B_{\text{PEAK}}= 547$ Gauss
- New developments are necessary to use all potential of QWRs which are built with the available SRF technology:
 - Advanced optimal EM and mechanical design
 - Fast piezoelectric or magnetostrictive tuners for low intensity beams
 - High power RF couplers for high current beams
 - Operation at $E_{\text{PEAK}}= 50$ MV/m $B_{\text{PEAK}}= 900$ Gauss is visible
 - Very high voltages – 4 MV per cavity are realistic even for lower beta ~ 0.075