

EEHG SEEDING DESIGN FOR SWISSFEL

E. Prat, S. Reiche, PSI, Villigen, Switzerland

Abstract

The SwissFEL facility, planned at the Paul Scherrer Institute, is based on the SASE operation of a hard (1-7 Å) and a soft (7-70 Å) X-ray FEL beamline. In addition, seeding is foreseen for the soft X-ray beamline, down to a wavelength of 1 nm. The Echo-Enabled Harmonic Generation (EEHG) scheme, which utilizes a rather complex manipulation of the longitudinal phase space distribution of the electron beam to generate high harmonic density modulation, is presently considered the first choice for seeding at SwissFEL. However, EEHG is highly demanding and complex at 1 nm, therefore other strategies like High-Harmonic Generation (HHG) and self-seeding are also evaluated. This paper presents the current status of the seeding design for SwissFEL based on EEHG.

INTRODUCTION

Seeding for FELs has several advantages in comparison to SASE: the FEL brilliance is increased because of the increased longitudinal coherence, the pulse to pulse spectral stability is increased, the temporal pulse shape is improved, the undulators become shorter, etc. Operation of a seeded soft X-ray beamline is planned at SwissFEL for 2018 down to a wavelength of 1 nm [1].

Among the different seeding strategies, High-Harmonic Generation (HHG) [2] and Echo-Enabled Harmonic Generation (EEHG) [3] are potential candidates for SwissFEL, while High-Gain Harmonic Generation (HG) [4] is not suitable because of the higher sensitivity to beam fluctuations and the energy spread increase in a “non-fresh” bunch approach [5].

HHG experiments have shown wavelengths down to 10 nm with an energy about 5 nJ [6]. Different experiments are presently trying to prove HHG seeding at around 50 nm under accelerator conditions [7, 8]. SwissFEL would require for 2018 an intense HHG source down to 5 nm, which through a single HG conversion would then allow to reach 1nm.

The EEHG scheme has been successfully tested for wavelengths of hundred nanometers [9, 10] and can

potentially produce high bunching directly at 1 nm, hence it is presently considered the first option for seeding at SwissFEL. However effects such as ISR/CSR can limit the performance for very short wavelengths. Both HHG and EEHG may be tested at the SwissFEL injector Test Facility [11] at around 50 nm from middle of 2013.

In addition to HHG and EEHG, self-seeding [12] is currently being investigated because it does not exhibit stringent “short wavelength” limitations as the EEHG or HHG schemes, which are getting extremely difficult to operate below 5 nm.

LAYOUT DESIGN

EEHG utilizes two modulators and two dispersive sections to generate high harmonic density modulation. In the first modulator a laser with a wavelength λ_0 is used to modulate the energy of the electron beam. After that the beam is over compressed in the first dispersive section. Then a laser with a wavelength $\lambda_1 = \lambda_0/K$ is used to do the second modulation, being K the ratio of the wavelengths of the two lasers. The electrons propagate then through a second dispersive section with a small strength to generate the bunching at λ_0/h , where h is the harmonic number. The beam is finally sent through the radiator which is tuned to the wavelength λ_0/h .

Figure 1 shows a sketch of the EEHG layout of the soft X-ray beamline of SwissFEL. The space required for the seeding is about 30 m (excluding the radiator). The electron beam has an initial energy of about 2.9 GeV. Two C-Band rf stations preceding the FEL allow tuning the energy between 2.4 and 3.4 GeV. Combined with a variable gap undulator the total wavelength range for SASE (0.7 nm – 7 nm) and seeding (1 nm – 7 nm) can be achieved with one radiator type ($\lambda_u = 40$ nm).

The radiator consists of 11 segments of 4 m each, which covers the required length to achieve saturation at the shortest wavelength in the SASE mode. The two modulators are 2.16 m long and have a period length of 360 mm. With these parameters the degradation of the EEHG process due to ISR effects is tolerable and the required laser power is within specifications.

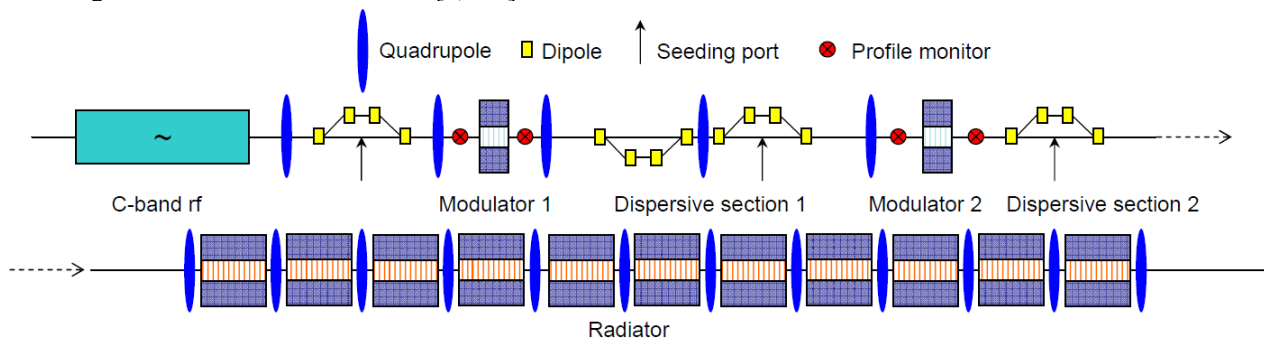

Figure 1: EEHG layout for the soft X-ray beamline of SwissFEL (not drawn to scale).

Copyright © 2012 by the respective authors/CC BY 3.0 — cc Creative Commons Attribution 3.0 (CC BY 3.0)

The first dispersive section is designed to provide a maximum R_{56} of about 10 mm with a maximum bending angle of about 2.2 degrees. It consists of two chicanes with four dipoles each. The dipole length is 1 m, the distance between the 1st and 2nd dipole (and 3rd and 4th) is 1m, and the distance between the 2nd and the 3rd magnet is 0.25m. The second dispersive section, less demanding in terms of R_{56} , consists of 4 dipoles with a length of 0.25 m each. The distance between the magnets is 0.5 m.

A third chicane will be installed upstream the first modulator to allow the in-coupling of the laser beam for the first modulation. Two more seeding ports will be needed: one at the first EEHG dispersive section for the coupling of the laser to the second modulator and one at the second dispersive section to couple a possible HHG source.

Quadrupole magnets along the lattice will control the beam sizes. Figure 2 shows the optics along the beamline. The average beta along the radiator is below 10 m.

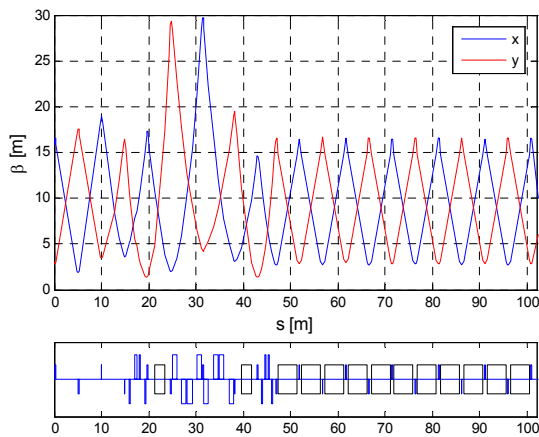

Figure 2: Beta functions along the EEHG beamline.

SIMULATIONS

EEHG Configuration

We assume an initial seed signal with a wavelength of $\lambda_0 = 250$ nm. To produce seeded FEL radiation at 1 nm we could generate EEHG bunching at a longer wavelength (e.g. 5 nm), produce FEL radiation at this wavelength with the first radiator segments, do a single harmonic conversion with a small chicane to 1 nm, and finally radiate at 1 nm with the last radiators. However, this solution is not beneficial because the induced energy spread in the first radiators would prevent the beam from later radiating at 1 nm. It is better to directly produce EEHG bunching at 1 nm with a harmonic conversion $h = 250$.

The EEHG scheme is controlled by four dimensionless parameters: the modulator parameters $A_1 = \Delta E_1 / \sigma_E$ and $A_2 = \Delta E_2 / \sigma_E$, where ΔE_1 and ΔE_2 are the energy modulation amplitudes and σ_E the initial energy spread of the beam; and the dispersive parameters $B_1 = R_{56}^1 \cdot k_0 \cdot \sigma_E / E$ and $B_2 = R_{56}^2 \cdot k_0 \cdot \sigma_E / E$, where R_{56}^1 and R_{56}^2 are the R_{56} of

the first and second dispersive sections, $k_0 = 2\pi/\lambda_0$ is the wave number of the initial seed signal, and E is the central energy of the electron beam.

The theoretical maximum bunching increases with A_1 until it reaches a weak dependence beyond a value above 5-6 [3], therefore we choose for our configuration $A_1 = 5$. To achieve maximum bunching the other three parameters have to approximately fulfill the following two equations:

$$\begin{aligned} (K \cdot m - 1) \cdot A_2 \cdot B_2 &= m + 0.81m^{1/3} \\ B_1 &= (K \cdot m - 1) \cdot B_2 \end{aligned} \quad (1)$$

Where $m = (h+1)/K$ for maximum bunching [3]. The parameters A_2 and B_1 are inversely proportional and the product $A_2 \cdot B_1$ increases with the harmonic number. The general strategy is to find a compromise between a high A_2 value (which requires high laser power and induces large energy spread) and a high value of B_1 (which requires large R_{56} that might impose a limitation due to ISR/CSR effects).

Concerning the initial beam energy E , on one hand it should be large so that the relative energy spread of the beam is sufficiently small for the FEL process. This condition puts a lower limit of about 2.8 GeV. On the other hand, ISR and CSR effects put a high limit of about 3.1 GeV. We presently consider an energy of 3 GeV. The initial uncorrelated energy spread of the beam, obtained from start-to-end simulations, is $\sigma_E = 350$ keV. We choose $A_2 = A_1 = 5$ – this way the final energy spread of the beam is about 1.8 MeV, enough to be able to drive the FEL process (the energy spread at saturation is about 3.5 MeV). A good starting value for B_1 and B_2 can be obtained from Equation 1. 1D simulations around these values are done to “fine-tune” the EEHG configuration.

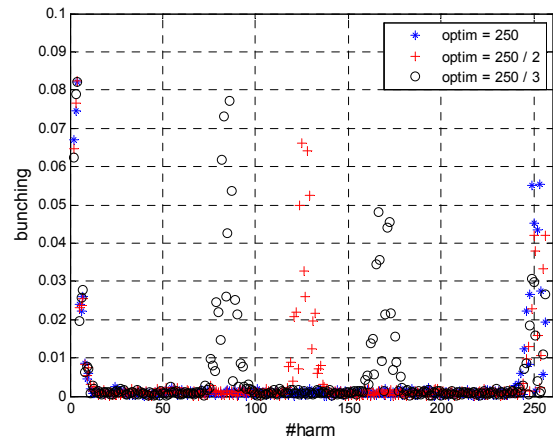

Figure 3: Bunching as a function of the harmonic number when optimizing the 250th harmonic (blue) the 125th harmonic (red) and the 83rd harmonic (black).

An important feature of the EEHG scheme is that significant bunching is created not only to the optimized harmonic but also to the higher harmonics. Therefore, as it can be seen in Figure 3, the optimum parameters for the 125th harmonic (and 83rd harmonic) will also give significant bunching at the 250th harmonic, with the advantage that the required R_{56}^1 is reduced by a factor of

2 (and 3). This can be seen in Figure 3: the bunching at the 250th harmonic is about 5.5% when directly tuned for the 250th harmonic, about 4.5% when optimizing the harmonic 125, and about 3% when optimizing the 83rd harmonic. The results are obtained from 1D simulations using one million particles. We choose the solution corresponding to the optimum parameters at the 125th harmonic as our working point. The EEHG parameters are: $A_1 = 5$, $B_1 = -25.5$ ($R_{56}^1 = -8.7$ mm), $A_2 = 5$, $B_2 = -0.205$ ($R_{56}^2 = -70$ μ m).

Genesis Results

Genesis [13] is used to simulate the EEHG scheme taking into account the beam-laser interaction in the modulators and the transverse effects. The transport of the electrons along the beamline is calculated with *elegant* [14]. *Genesis* is also used to obtain the curve that relates the modulation A parameters with the required laser power. Based on start-to-end simulations results, we assume that the beam has a normalized emittance of 0.4 μ m, a peak current of 2.7 kA, and a beam charge of 200 pC. For $A = 5$ and our modulator and beam parameters the required laser power is about 1.1 GW. The power of the second laser (A_2) and the R_{56} of the second dispersive section (B_2) are finely scanned around the 1D configuration optimum in order to find the maximum bunching at 1 nm. Once the optimum is found, the radiation at 1 nm is simulated.

Figure 4 shows the longitudinal phase-space for the optimum parameters. Simulations are done with one million particles. The bunching at 1 nm is around 4%, very close to the optimum 1D bunching value (around 4.5%). The newly scanned EEHG parameters are very close to the 1D optimal values: $A_2 = 4.96$, $B_2 = -0.209$. The required laser powers are about 1.10 GW for the first modulation and 1.07 GW for the second one.

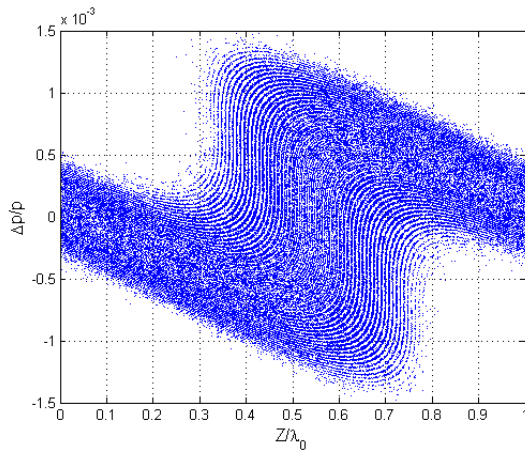

Figure 4: Longitudinal phase-space at the radiator entrance. Bunching at the 250th harmonic is about 4%.

Figure 5 shows the radiation power at 1 nm and the electron beam energy spread along the radiator. Saturation can be achieved in about 20 m, i.e. 6 out of the 11 available radiator segments would be enough for EEHG seeding. Saturation power is close to 3 GW.

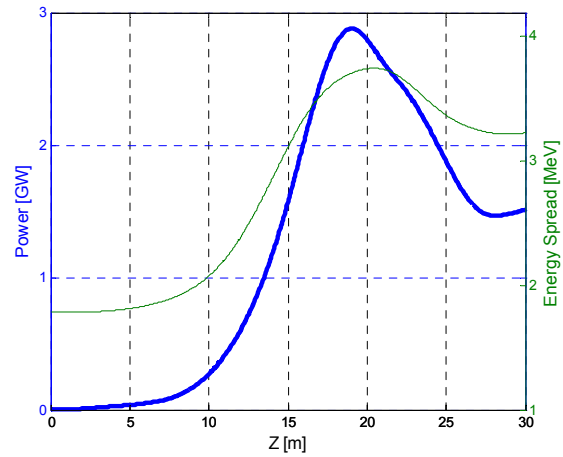

Figure 5: Radiation power at 1 nm and electron beam energy spread along the radiator.

Parameter Sensitivities on Bunching

Figure 6 shows the simulated bunching dependence on the modulation laser powers and chicane strengths. Only one parameter is varied around the optimum configuration at each time. As expected, bunching is remarkably stable as a function of the power of the first laser but it is more sensitive to the power of the second seed laser, the variation of which have to be kept $\pm 1.5\%$ around the optimum in order not to lose more than 10 % of bunching. Concerning the dispersion strengths, the R_{56} can not be varied more than $\pm 0.2\%$ in order to keep 90% of the initial bunching, i.e. the bending angle has to be stable in $\pm 0.1\%$, which is a very relaxed tolerance. On the other hand, the initial wavelength λ_0 should not vary more than $\pm 1.5\%$ to keep at least 90% of the optimum bunching (assuming that $\lambda_0 = \lambda_1$).

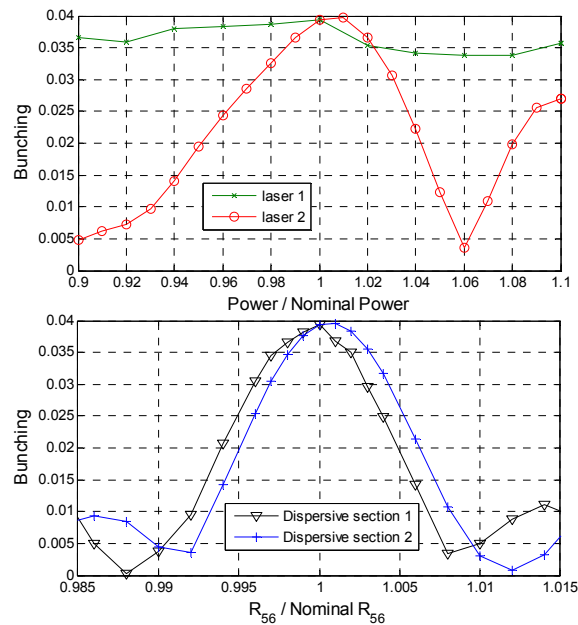

Figure 6: Bunching as a function of modulation laser powers (upper plot) and dispersion strengths (lower plot).

Figure 7 shows the bunching dependence on the normalized projected emittance and the energy spread of the initial electron beam. None of these two parameters seem to be critical to keep high bunching, i.e. emittance should be better than about $1.1 \mu\text{m}$ and energy spread below about 500 keV to still have more than 3% of bunching. It should be noted that the EEHG optimization is done for the design parameters and that a change of these parameters would imply a new optimization of the EEHG seeding section.

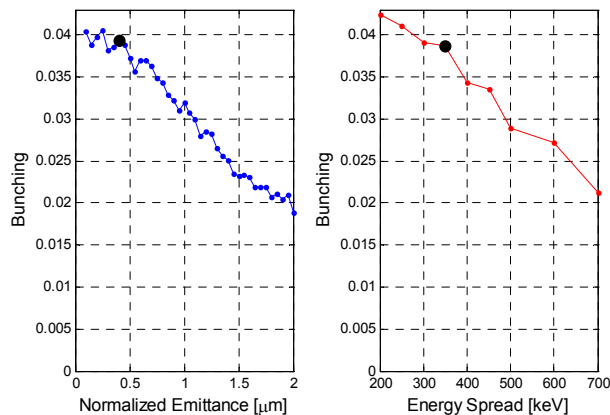

Figure 7: Bunching as a function of the normalized emittance (left plot) and energy spread (right plot) of the beam. Black dots correspond to the design values.

Issues Affecting EEHG Performance

Due to the transverse size of the electron and laser beams, electrons with different radial positions see laser field of different amplitudes, which can smear the density modulation. To avoid such degradation the laser beam size should be at least 3 times larger than the electron beam size [3]. Considering an electron emittance of $0.4 \mu\text{m}$ and the beta functions plotted in Figure 2, in our case the electron beam size is always well below $50 \mu\text{m}$, which means that the laser beam size should be at least $150 \mu\text{m}$. A laser beam waist of $500 \mu\text{m}$ has been assumed in the simulations presented in this paper.

ISR may affect the EEHG seeding because of the energy diffusion due to quantum fluctuations in the process of radiation in both modulators and chicanes. Moreover, the CSR produced in the dispersive sections can distort the phase space structures required for the EEHG and also result in an emittance growth. ISR and CSR effects will be especially important in the first dispersive section due to its relative large dispersion strength.

First calculations done with *elegant* show a reduction of the bunching due to ISR/CSR of about 40% and a projected emittance increase of a factor of 3.7. The main limitation comes from the strong CSR produced by the extremely short electron bunches – the rms bunch length is about $10 \mu\text{m}$ – when passing through the first dispersive section. To improve this situation the bunch length could be increased while keeping enough peak current to drive

the FEL. For a maximum bunch length of about $20 \mu\text{m}$ the bunching decrease would be reduced to 30% and the emittance increase would be about 40%. Despite the bunching and emittance degradation, the EEHG seeding would still work for the two described cases, i.e. GW of power would be produced in the radiator at 1 nm.

OUTLOOK

Different strategies will be investigated to improve the ISR/CSR degradation. One of them is to use quadrupole magnets in the dispersive sections to help generating the required R_{56} while reducing the bending angle.

Another approach would be to use a laser in the second modulator with a higher harmonic of the initial seed laser (i.e. using $K > 1$). For instance, for $A_2 = 5$ and $K = 3$ ($\lambda_1 = 83.3 \text{ nm}$), the required R_{56} in the first dispersive section would be only about 3 mm. Studies will be done on this hybrid mode that combines the EEHG (with $K > 1$) and the HHG to generate the laser for the second modulation.

Moreover, complete 6D start-to-end simulations will be performed. They will allow to study properties like the radiation spectrum and to investigate effects such as the initial energy chirp of the beam. For that *Genesis* will be soon updated to allow time-dependent simulations using the EEHG technique at short wavelengths.

REFERENCES

- [1] R. Ganter et al, SwissFEL Conceptual Design Report, PSI-Bericht 10-04.
- [2] M. Ferray et al., Journal of Physics B: Atomic Molecular and Optical Physics 21, **L31** (1988).
- [3] G. Stupakov, D. Xiang, Phys. Rev. ST Accel. Beams **12**, 030702 (2009).
- [4] L. Yu, I. Ben-Zvi, Nucl. Instr. and Meth. A **393** 96 (1997).
- [5] S. Reiche et al., “Seeding option for the soft X-ray beamline of SwissFEL”, Proceedings of the FEL 09, Liverpool, UK, 2009.
- [6] K. Midorikawa, Phys. Rev. Lett. **88**, 1422 (1999).
- [7] J. Bødewadt et al., “sFLASH – First results of direct seeding at FLASH”, Proceedings of the FEL 10, Malmö, Sweden, 2010.
- [8] G. Lambert et al., Nature Physics **4**, 296–300 (2008).
- [9] D. Xiang et al., “First demonstration of the echo-enabled harmonic generation technique for short-wavelength seeded free electron lasers”, SLAC-PUB-14199, 2010.
- [10] Z. Zhao, “Seeding Experiments at the SDUV-FEL”, presented at this conference.
- [11] M. Pedrozzi et al, 250 MeV Injector Concept Report. Accelerator test facility for SwissFEL, PSI-Bericht 10-05.
- [12] J. Feldhaus et al, Opt. Commun., **140**, p.341 (1997).
- [13] S. Reiche, “GENESIS 1.3 User Manual”, 2004.
- [14] M. Borland, “elegant: A Flexible SDDS-Compliant Code for Accelerator Simulation”, Advanced Photon Source LS-287, September 2000.