

A 54.167 MHZ LASER WIRE SYSTEM FOR FREE ELECTRON LASER IN CAEP *

Dai Wu[#], Ming Li, Wei Bai, Hanbin Wang, Jianxin Wang

Department of Engineering Physics, Tsinghua University, Beijing, 100084, P.R.China

Institute of Applied Electronics, Chinese Academy of Engineering Physics (CAEP/IAE), Mianyang, 621900, P.R.China

Abstract

The laser wire (LW) method has been demonstrated as an effective non-interceptive technique for measuring transverse electron beam size of CW FELs and ERLs. To measure the beam size of a CW DC gun, which is built as an electron source of THz FEL in China Academy of Engineering Physics (CAEP), a high repetition LW system is proposed. The first proposed system is going to be installed at the exit of the DC gun, where the energy of electron beam is extremely low. In this paper, the LW system adapted to the FEL beam parameters is discussed, and the main parameters are given.

INTRODUCTION

Transverse electron beam size measurement with non-intercepted technology is an active research domain in high average current free electron lasers (FELs) and energy recovery linacs (ERLs) [1]. In the case of CAEP (Chinese Academy of Engineering Physics) THz FEL, the electron beam repetition rate is going to be 54.167 MHz and the average current will be up to 3~5 mA. The traditional diagnostic tools such as OTR, scintillator and wire scanner are no longer suited because of the large average beam power.

In the GeV level colliders development, the LW (Laser Wire) method was proposed and used for non-intercepted transverse beam size measurements [2, 3]. This method intercepts electron beam by laser beam instead of screens or metal wires and counts the Compton scattering photons isolating from the electron beam by a dipole in the downstream. LW has also found applications in Thomson region at lower energy [4], and been proposed in BNL ERL [5].

In this paper, a prototype 54.167 MHz LW working with a mode-lock picosecond laser is proposed for CAEP FEL which will be work in CW mode. Furthermore, the electron beam energy will be extremely low for the prototype LW system is going to be setup at the exit of the CW DC gun. As a result, the scattered photon will be in the VUV region and LW system could be without a dipole. The LW system adapted to the FEL beam parameters is discussed, and the main parameters are given.

PHYSICAL MODEL

We consider a single electron with relativistic energy γ_0 and photon with energy $h\nu_0$ colliding, as shown in Figure 1. ψ is the colliding angle between photon and electron. θ is the Compton scattering angle and $h\nu_{sc}$ is the energy of Compton scattering photon. The ν_{sc} is given [3]

$$\frac{\nu_{sc}}{\nu_0} = \frac{1 - \beta_0 \cos \psi}{1 - \beta_0 \cos \theta + \xi [1 - \cos(\psi - \theta)]} \quad (1)$$

where β_0 is electron's relativistic velocity. ξ is the ratio of incident photon energy and electron energy.

In the Thomson region (low energy photon and electron), equation (1) is reduced to

$$\frac{\nu_{sc}}{\nu_0} = \frac{1 - \beta_0 \cos \psi}{1 - \beta_0 \cos \theta} \quad (2)$$

The spatial distribution of the scattered photons is given by Compton process cross section:

$$\frac{d\sigma_c}{d\Omega} = \frac{(E_0 r_e h\nu_{sc})^2 (1 - \beta_0 \cos \psi)}{2\kappa_0^2} \cdot \left\{ [E_0^2 (\kappa_0^{-1} - \kappa_1^{-1}) + 1]^2 + \frac{\kappa_1}{\kappa_0} + \frac{\kappa_0}{\kappa_1} - 1 \right\} \quad (3)$$

where E_0 is the electron rest energy. r_e is the classical electron radius. $\kappa_0 = h\nu_0 \gamma_0 E_0 (1 - \beta_0 \cos \psi)$ and $\kappa_1 = h\nu_{sc} \gamma_0 E_0 (1 - \beta_0 \cos \theta)$.

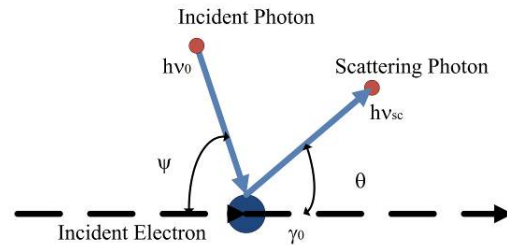

Figure 1: Diagrammatic sketch of Compton scattering process.

Figure 2 shows the basic LW system setup and the detail of the interact spot. The RMS dimension of electron beam is σ_x , σ_y and σ_z . The laser waist RMS size is σ_w . And the laser RMS length is σ_L . When the laser scans the electron beam along y axis, the distance between both centers of electron and laser beam is δy . The count rate of scattered photons is given:

*This work is supported by CAEP/IAE with grant (2011JFZY01) and National Science and Technology Development Program of China.

[#]Correspondence author: wu-d04@mail.tsinghua.edu.cn

$$N_{sc}(\delta y) = f \cdot (N_{sc})_{center} \exp\left[-\frac{\delta y^2}{2(\sigma_y^2 + \sigma_w^2)}\right] \quad (4)$$

Where f is the repetition of colliding and $(N_{sc})_{center}$ is the scattered photon number of center-to-center colliding, which is given:

$$(N_{sc})_{center} = 2\pi^{3/2} \alpha K^2 N_e \left(\frac{\Delta\lambda}{\lambda}\right) \frac{\sigma_L \sigma_w^2}{\lambda_u \sqrt{(\sigma_x^2 + \sigma_w^2)(\sigma_z^2 + \sigma_y^2 + \sigma_L^2 + \sigma_w^2)}} \quad (5)$$

All the parameters in equation (3) and their physical significance can be found in reference [3].

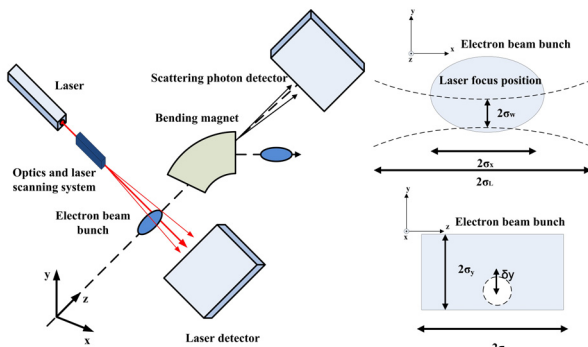

Figure 2: Basic LW system sketch and the electron-photon colliding detail.

NUMERICAL STUDIES AND SIMULATIONS

To measure the transverse beam size of CW DC Gun in CAEP, a prototype of CW LW system is proposed. The mode lock laser for scanning electron beam is separated from 8W drive laser of the photocathode CW DC gun. The sketch of experiment setup is shown in Figure 3, and the main parameters are given in Table 1, where the electron transverse size and emittance are calculated with a code of Parmela [6] and described in Figure 4.

The simulations are carried out with a code of CAIN [7]. In this code, the laser power is increased by 54.167×10^7 times to make the CW LW equal to a single shot one. In order to prove the feasibility of this multiplication, Figure 5 shows the linear relationship between laser power and scattered macro-particle yield.

Numerical and simulation results are shown in Table 1, Figure 6 and Figure 7. The scattered light wavelength is in the VUV region because of extremely low electron energy and the critical angle is relatively large. CAIN code gives 52 macro-particles in the observation angle, each of them weight 620, so the scattered photon number is 3224, which is agree well with the numerical result.

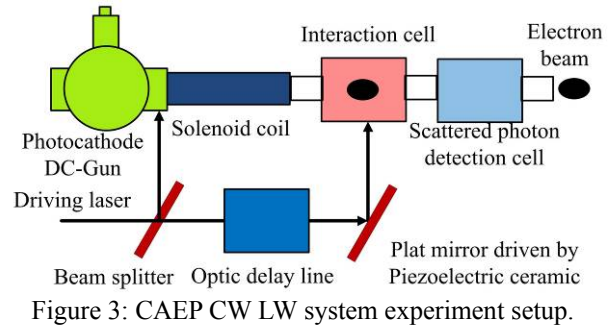

Table 1: LW Parameters for CAEP FEL CW DC Gun

Electron Beam	
Beam energy (E_k)	250 keV
Beam repetition rate (f)	54.167 MHz
RMS bunch length (σ_z)	15 ps
Charge per bunch (Q)	100 pC
Transverse Emittance (ϵ_x, ϵ_y)	1.5 mm.mrad
Transverse beam size (σ_x, σ_y)	1000 μ m
Laser Beam	
Wavelength (λ_L)	532 nm
RMS waist size (σ_w)	50 μ m
Repetition rate (f)	54.167 MHz
Pulsed energy at interaction point (W)	55.4 nJ
Focal length (f_L)	1000mm
Beam quality (M^2)	1.4
Pulse duration (σ_L)	5 ps
Numerical calculations of scattered photon	
Minimum of photon wavelength (λ_{sc})	137.8 nm
Detector distance /area (d/S)	0.3m/78 cm ²
Count rate of scattered photons ($N_{sc}(0)$)	3595 s ⁻¹

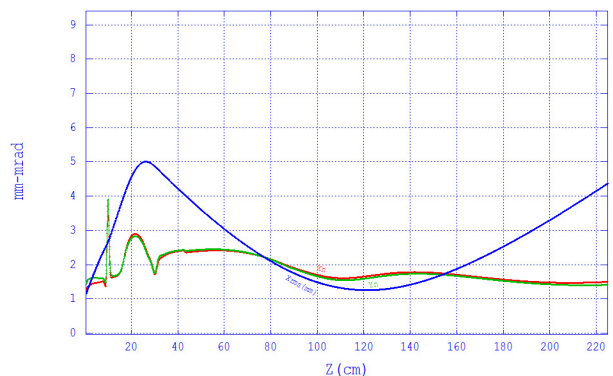

Figure 4: Transverse beam size and emittance versus z position calculated with a code of Parmela.

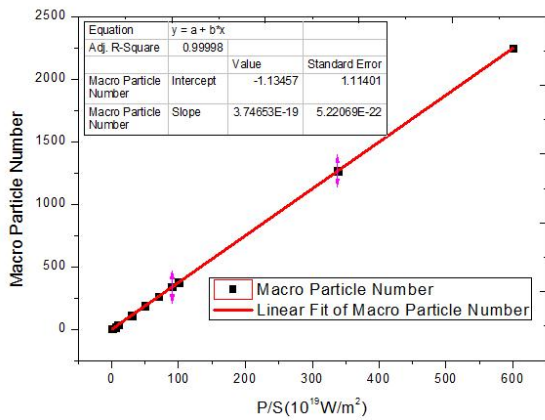

Figure 5: Scattered photon number versus laser power density.

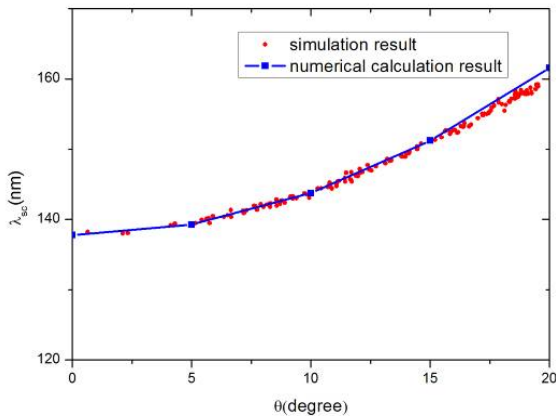

Figure 6: Scattered light wavelength versus observation angle.

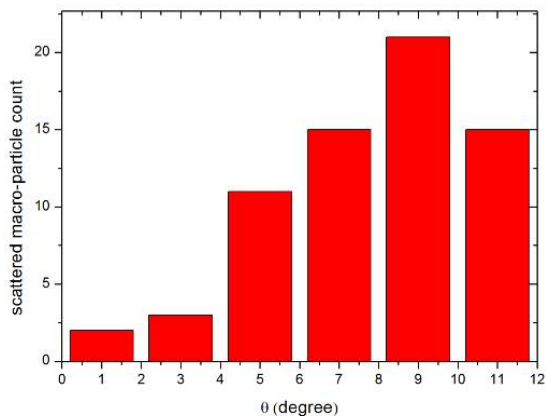

Figure 7: macro-particle count versus observation angle.

EXPERIMENT PROPOSAL

Because the photons are in the VUV region, the detector of scattered photon should be chosen to fit the wavelength. For this reason, a photomultiplier tube (PMT) working in single-photon count mode in the wavelength region from 115nm to 320nm is going to be used. Furthermore, the open angle is relatively large, so two off axis MgF₂ coated Aluminium parabolic mirrors are used to collect photons arriving at the PMT. The outline of the scattered photon detection cavity is shown in Figure 8.

The whole cavity is in vacuum environment to protect the VUV photons. The whole experiment platform is going to be set up in December, 2011.

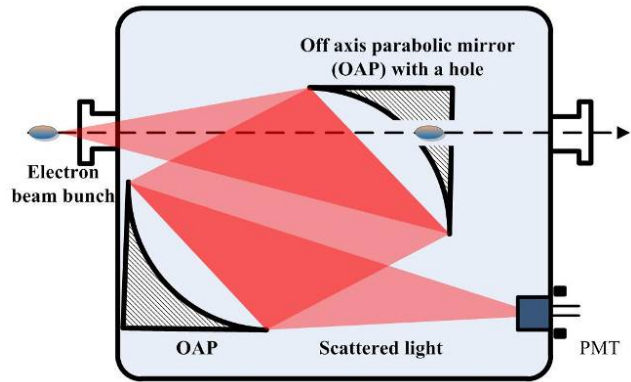

Figure 8: The outline of the scattered photon detection cavity.

CONCLUSIONS

In this paper, a new type of CW LW system is discussed for measurement transverse electron beam size. This LW with a 54.167MHz mode-lock laser works at extremely low energy, and the scattered photon detector of which works in VUV region. No bending magnet cavity with parabolic mirrors and VUV PMT are proposed for scattered photon detection. From this design with its numerical studies and simulation researches, the photon flux through the detector is estimated to be around 3×10^3 per second. The system is going to be set up in December, 2011, and will measure the transverse beam size of DC gun of CAEP CW FEL.

REFERENCES

- [1] D. Gassner, "R&D ERL: Diagnostics", Brookhaven National Laboratory report BNL-09025-2010-IR (2010).
- [2] T. Shintake, *Nucl. Instr. Methods A* **311**, 453 (1992).
- [3] T Lefèvre, "Laser Wire Scanner: Basic Process and Perspectives for the CTFS and CLIC machines", CLIC Note, 2002, vol. 504: 2001-015.
- [4] W.P. Leemans *et al.*, *Phys. Rev. Lett.*, **77**(20), 4182,(1996).
- [5] A. Murokh *et al.*, "A 10 MHz Pulsed Laser Wire Scanner for Energy Recovery Linacs", IPAC's 2010, Kyoto, MOPE095, p .1209 (2010).
- [6] L. M. Young, "PARMELA", Los Alamos National Laboratory report LA-UR-96-1835 (Revised April 22, 2003).
- [7] K. Yokoya, CAIN home page, <http://www-acctheory.kek.jp/members/cain/default.html>