

NOVEL RF STRUCTURE FOR ENERGY MATCHING INTO AN RFQ*

V. Zvyagintsev[†], Z. Ang, N. Avrelino, T. Au, J. Keir, R.E. Laxdal, M. Marchetto, B. Waraich, TRIUMF, Vancouver, Canada, A. Cote, UBC, Vancouver, Canada

Abstract

A small 3-gap RF structure at 11.8 MHz has been designed and installed to provide energy matching to the ISAC RFQ for cases where the required source potential ($E \leq 60\text{kV}$) cannot be achieved. The accelerating structure operates in pi-mode and provides a maximum effective accelerating voltage of 16 kV to the low energy ions. Beam dynamics considerations, RF and mechanical design will be described. First results of RF tests of the structure will be given.

INTRODUCTION

The ISAC RFQ [1] operates at 35.36 MHz and is designed to accelerate pre-bunched beams with $A/Q \leq 30$. A three harmonic pre-buncher, located 5m upstream of the RFQ (Fig. 1), operates with a fundamental frequency of 11.8 MHz so that one of every three RFQ buckets is filled. The RFQ requires an ion injection energy of 2.04 keV/u ($\beta = v/c = 0.208\%$) with a phase acceptance for 60% transmission of $\delta E/E = (-1.5\%, +4.5\%)$ and $\delta\phi = \pm 25$ deg (35MHz). The transverse acceptance is 140 μm .

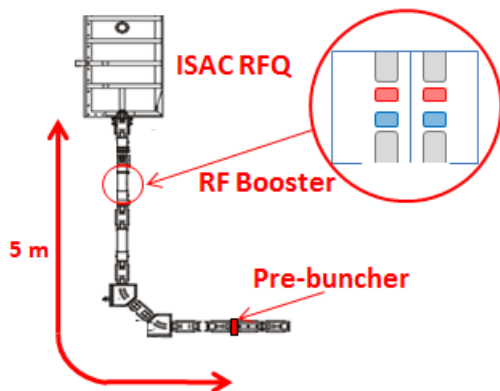

Figure 1: The ISAC Pre-buncher, RF booster and RFQ.

The injection energy acceptance requires that the ions (typically radioactive ions produced via the ISOL method) have to be extracted from a source at a terminal voltage up to ~ 60 kV. The ISOL target modules operate in a harsh environment that can limit the source bias. Presently the ISAC target modules cannot hold more than 54 kV and this value can degrade with time meaning that scheduling experiments for ions with $A > 25$ presents a risk.

In order to allow the acceleration of high mass beams and to mitigate against further source bias degradation a 3-gap RF structure has been designed and installed just up-stream of the RFQ. The actual voltage required from the booster is dependent on the source potential and the

A/Q value of the ion. The effective voltage required from the booster is given by

$$V_{boost}[\text{kV}] = 2.04 \frac{A}{Q} - V_{source}[\text{kV}] \quad (1)$$

The booster is specified to deliver an effective voltage of 16 kV to cover known source issues with a reasonable margin. To limit gross beam emittance growth we stipulate that the RF booster operation be limited to add no more than 50% of the required injection energy such that at the maximum voltage the incoming velocities would range from 0.147% to 0.178% depending on the A/Q of the ion with final velocity in all cases of 0.208%.

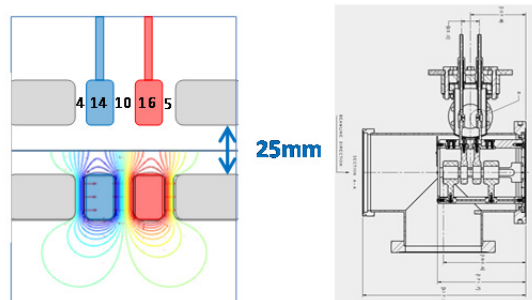

Figure 2: The electrode geometry, field and design.

ELECTRODE DESIGN

The RF booster is a three gap device operating at 11.78 MHz in push pull mode with a tube to ground voltage from 0 to 8.5kV. The drift tube geometry is chosen to optimize the efficiency over the velocity range of interest. Due to the large velocity swing a graded beta structure is chosen (Fig. 2). The tube lengths and gap dimensions are shown in Table 1.

Table 1: Electrode Geometry

Device	Length (mm)	V_0 (kV)	β_0
Grounded tube	30	0	
Gap 1	4		
Drift tube 1	14	≤ 8.5	0.165% (g1-g2)
Gap 2	10		
Drift tube 2	16	≤ 8.5	0.185% (g2-g3)
Gap 3	5		
Grounded tube	30	0	

In order to be transparent to the beam the full aperture is 25.4 mm to match the aperture of other electrostatic beamline elements. Due to the low beta this means that there is considerable field penetration into the drift tube that reduces the efficiency.

*TRIUMF receives federal funding via a contribution agreement through the National Research Council of Canada.

[†]email address: zvyagint@triumf.ca

The fields are calculated by COMSOL [2] using an axially symmetric coordinate system. The accelerating field distribution $E_z(z)$ is presented in Fig. 3 for different radial positions. The radial dependence in the fields, due to the large aperture to gap ratios, produces a strong variation in efficiency as a function of radial position with two components:

1. The leakage of the electric field into the drift tube
2. The transit time factor (TTF) due to the broad field profile.

A summary plot of the two components and the total efficiency are plotted in Fig. 4 for the extreme case where an ion of $\beta=0.152\%$ is accelerated to $\beta=0.208\%$. For $A=16$ and a tube voltage of 8 kV on axis particles would see an effective voltage of 15.3 kV to reach the RFQ injection energy of 32.6 keV while particles at $r=3.5, 7$ mm would reach 33.9, 37.2 keV ($\delta E/E=4\%, 13.9\%$). For other initial velocities varying from $\beta=0.147\%$ to 0.208% the on-axis efficiency is given by $\xi = -29.5\beta(\%)^2 + 11.8\beta(\%) - 0.65$ and varies from 0.46 to 0.54 over the design velocity range. The radial variation will strongly couple beam width to energy spread and limit the acceptance by the RFQ. A $\epsilon_{xy}=50 \mu\text{m}$ beam has an expected 2σ width of 7 mm so for the case above and considering the RFQ phase acceptance only 1σ would be accepted. Less ex-treme cases will have a larger acceptance.

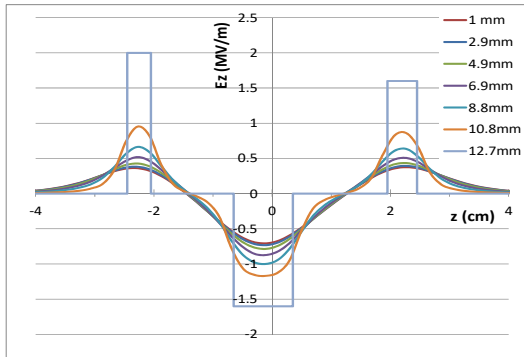

Figure 3: Accelerating field distribution $E_z(z)$ for different radial position.

To get the accumulated transverse kick the transverse force is integrated: $p_x(r) = \int dp_x(r) = \int qE_x(r,t)dt$ and the radial kick is given by: $\alpha = \frac{\Delta p_x}{p} = \frac{c\Delta p_x}{\beta\gamma E_0}$. A reasonable fit

to the radial kick is given by: $\alpha = \frac{Q \pi V_{eff} \sin(-\varphi)}{A E_0 \lambda (\gamma\beta)^3} r$,

where φ is the average particle phase, r is the radial position, λ is the RF wavelength, A is the ion mass, E_0 the nucleon rest energy and $V_{eff} = 4 \cdot V_{tube} \cdot \xi \approx 2 \cdot V_{tube}$.

This gives a focal length of $\ell_{focal} = \frac{A E_0 \lambda \beta^3}{Q \pi V_{eff} \sin(-\varphi)}$ and for the $A=16$ extreme case $\ell_{focal} = \frac{28\text{mm}}{\sin(-\varphi)}$. The expected

RF kick from this extreme case is at the limits of the

matching quadrupoles of the RFQ where focal lengths range from 125 to 500 mm.

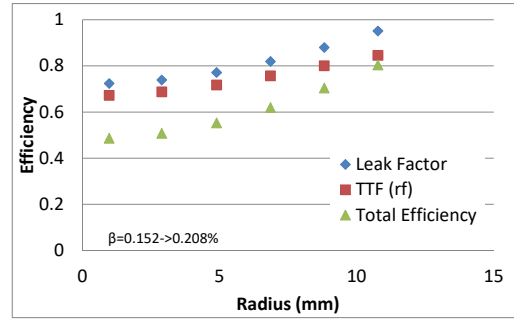

Figure 4: Accelerating efficiency as a function of radius showing two components – the field leakage and the TTF.

RF STRUCTURE

To provide a compact design of the resonant structure at 11.78 MHz we have to use lumped components. The structure consists of the cavity with drift tubes in vacuum to accelerate the beam and an air RF high voltage transformer connected to the electrodes with HV RF vacuum feedthrough. A 3-gap design enables the specified effective voltage of 16kV with a 2-phase RF voltage below 9 kV that can be reliably transferred with commercially available RF HV feedthroughs.

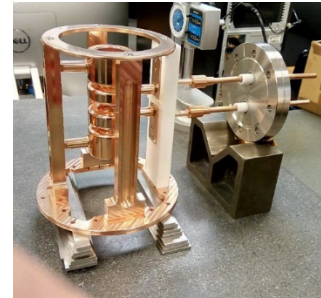

Figure 5: The RF booster electrodes and RF feedthroughs.

The 3-gap accelerating structure is based on a frame skeleton from copper bars and rings supporting and aligning drift tubes inside of stainless steel 6” T-section with upstream, downstream and pumping port flanges. For the cavity drive a custom made Solid Sealing [3] FA34778CA twin feedthrough was developed based on FA11559 RF feedthrough rated for 14 kV DC and 100 A @ 13.56 MHz. The feedthrough is mounted on CF4.5 flange on stainless 3” ‘cross’ welded to the 6” T-section; there are two additional ports for installation access to the feedthrough and for convectron and ion gauges for vacuum diagnostics. The inner drift tubes are installed on Macor insulator bar and connected to the feedthrough 1/4” copper leads by means of bolted sleeves (see Fig. 5).

The Cavity RF Model

The cavity design was verified with 3D simulation in Comsol [2] RF Module. The simulation has been done in Driven mode for a 2-phase RF source with an amplitude of 9 kV at 11.78 MHz.

- Power dissipation for each inner drift tube (considering Cu) is < 0.5 W and for the grounded drift tubes in total < 0.05 W so that the Cu $\frac{1}{4}$ " leads and Cu sleeves will provide an adequate heat sink for the structure.
- Capacitance of the inner drift tubes to the ground is ~ 15 pF; RF current to each inner drift tube is ~ 10 A.

RF CIRCUITRY

The RF circuitry was developed to provide the RF drive in according to the following considerations:

- 2-phase 9 kV at 11.78 MHz for a capacitive load of 25 pF (15 pF – each inner drift tube capacitance, 10 pF – capacitance of the ceramic RF feedthrough) – RF transformer pi-mode - coil grounded in the middle resonating with a capacitive load
- Simple frequency and matching tuning – to avoid frequency tuner in the cavity vacuum the tuner is implemented in the primary contour of the circuitry. This allows cheap variable capacitors with air dielectric.

RF Circuitry Simulations

The schematic presented on Fig. 6 is developed and simulated with Micro-Cap [4]. C4 and C5 present the capacitive load of the cavity. L1, L2 – secondary and L3, L4 – primary coils of the RF transformer. C1 and C2 – are variable capacitors for frequency and matching tuning. Resistors R1, R2 and R3 take into account losses in the coils with an assumed conservative quality factor of 50. C3 and C6 are 50 ohm loaded capacitive pickups to balance the outputs (V2 and V9 are relative to ground) and provide feedback for operation of the RF system.

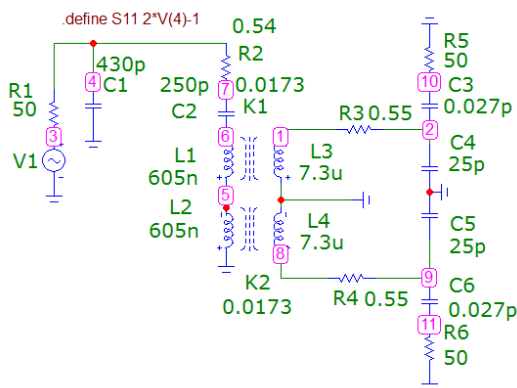

Figure 6: Schematics of the RF circuitry.

For 9 kV at 11.78 MHz the input power required is estimated at ~ 150 W.

RF Box Design

The RF circuitry is implemented in the RF Box presented in Fig. 7. The coils are made from $\frac{1}{2}$ " copper tube. Tests show that most of the heat dissipation is in the secondary coil. The coil is connected to the ground with a copper heat sink block and it is cooled with two fans mounted outside of the case. The primary coil is installed

on an insulator support with 3 degrees of movement to adjust the coupling and balancing. The effect of the capacitive coupling between the primary and secondary coils re-quires care since for a symmetrical configuration the output voltage for the lower part of secondary coil (in front of grounded side of primary coil) is less than for upper part. The tuning mechanism provides the possibility for balance adjustment by means of transverse shift and rotation of the primary coil. Two pairs of air dielectric variable capacitors are installed for rough and fine tuning.

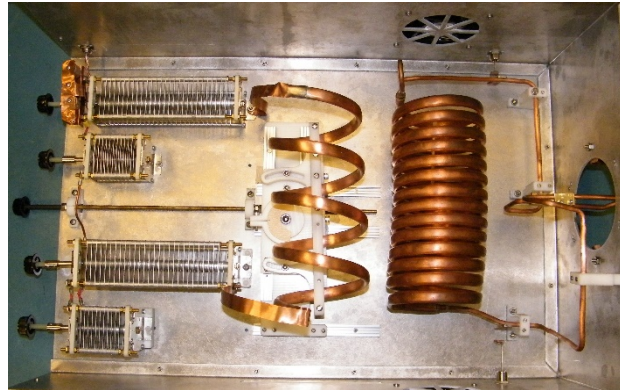

Figure 7: The RF circuitry inside of the RF Box.

Initial testing of the RF circuit was done with two 25 pF HV RF capacitors as a load. After RF tuning it is determined that 9 kV operation requires 120 W of input RF power. A 300 W Solid State RF power amplifier is available for operation of the structure.

CONCLUSIONS

The cavity and RF Box are installed in ISAC-I beam line. The first acceleration test of the RF booster system is schedule for June 2017. The final LLRF board will be available in late 2017.

ACKNOWLEDGMENT

We appreciate Thomas Varughese and Sanjay Kedia from IUAC (India) for their help with this project.

REFERENCES

- [1] R.E. Laxdal, "ISAC-I and ISAC-II at TRIUMF: Achieved Performance and New Construction," *Proc. LINAC2002*, May 2002, paper MOP057.
- [2] COMSOL, <https://www.comsol.com/>
- [3] Solid Sealing Technology, Inc., <http://www.solidsealing.com/>
- [4] Spectrum Software Micro-Cap, <http://www.spectrum-soft.com/index.shtml>