

WIDE-BAND LOW-POWER DRIVER OF THE LOW OUTPUT-IMPEDANCE RF SYSTEM FOR A PROTON SYNCHROTRON

T. Oki¹, Y. Irie, S. Takano, KEK, 1-1 Oho, Tsukuba-shi, Ibaraki, 305-0801, Japan

Abstract

Cathode-follower is well known by its low output impedance characteristic. However, it has not been applied to synchrotrons, because of its poor voltage gain and thus the huge power consumption in the driver stage. This problem can be solved by driving between grid and cathode of the final tube with an isolation transformer. The key issue to the transformer is to realise a high coupling coefficient, but less capacitance between primary and secondary coil windings. The core of the transformer is made of magnetic alloy FT-3M with 3-turn windings each. The coupling coefficient is more than 0.986 below 9 MHz with a capacitance between coil windings of 31.5 pF. The model system has been tested under frequency modulation in the 2-6 MHz range at 40 Hz repetition, resulting in a voltage gain of 6-11 and several tenths of ohms typically for an output impedance.

1 INTRODUCTION

In the cathode-follower (CF), an RF cavity is connected to the cathode of tube. The output impedance is given by

$$\left(\frac{1}{Z_{pg} + Z_{gk}} + \frac{1 + \mu\beta}{r_p} + \frac{1}{Z_k} \right)^{-1} \quad (1)$$

with

$$\beta = \frac{Z_{gk}}{Z_{pg} + Z_{gk}}$$

where μ is the amplification factor, r_p the plate resistance of the tube, Z_k the load impedance, Z_{pg} the grid-plate (ground) impedance and Z_{gk} the grid-cathode impedance. The main term in the bracket of Eq. (1) is the second one. Then, low output impedance is realised unless $Z_{gk} \ll Z_{pg}$; the output impedance loses its low value when Z_{gk} is very small.

The voltage gain (α) which is defined as the ratio of the cathode voltage (v_k) to the driver voltage (v_d) is given by

$$\frac{v_k}{v_d} = \alpha = \frac{\mu}{\mu + 1} \frac{Z_k}{Z_k + r_p / (\mu + 1)},$$

which is usually close to unity ($|\alpha| \leq 1$). However, the voltage across grid and cathode (v_{gk}), which forms a voltage generator, is only a few percent of the applied voltage since

$$v_{gk} = (1 - v_k/v_d)v_d = (1 - \alpha)v_d.$$

In order to dispense with the unnecessary voltage swing of the driver, a direct grid-cathode driving scheme by means of the isolation transformer is investigated (floating grid-cathode driving scheme) [1]. Fig. 1 shows the comparison of the two schemes.

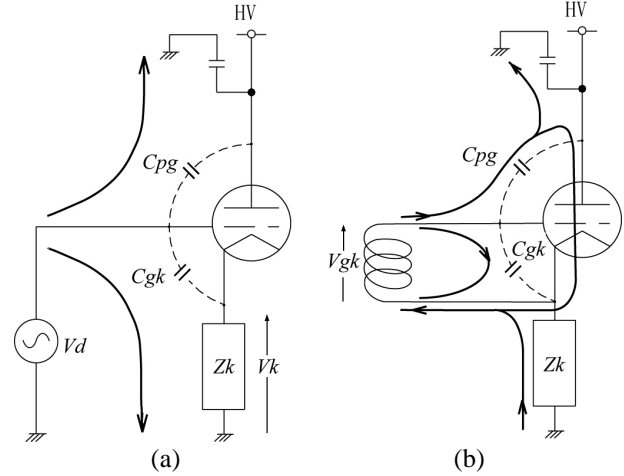

Fig. 1: Comparison of the (a) CF and (b) floating grid-cathode driving scheme

Then, the ratio of v_k to v_{gk} is written by

$$\frac{v_k}{v_{gk}} = \frac{v_k}{v_d - v_k} = \frac{\alpha}{1 - \alpha},$$

and the driver voltage can be considerably reduced by a factor of $(1 - \alpha)$. It should be pointed out that in the new scheme the driver feeds the same amount of current through the grid-plate capacitance (C_{pg}), but the necessary voltage is $1/(1 - \alpha)$ -times less. The output impedance of the new scheme is still low, as will be shown in a section 3.

2 ISOLATION TRANSFORMER

The isolation transformer requires high coupling coefficient but small capacitance and good isolation between the primary and secondary coils. Although these requirements contradict with each other, the following one has been obtained after many trials. The core of the transformer is magnetic alloy FT-3M; the outer dimension of the core is a 191 mm in width, 119 mm in height and 77 mm in depth, and the inner hole has a shape of 137 mm in width and 67 mm in height. The primary and secondary coils are wound with 3-turns around one

¹ also RCNP, Osaka University, Osaka, 567-0047, Japan

side with 12 mm apart. The equivalent circuit is expressed in Fig. 2.

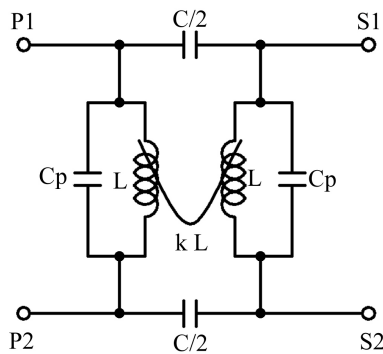

Fig. 2: Equivalent circuit of the isolation transformer

In order to obtain the inductance (L), coupling coefficient (k), capacitance between coils (C) and that across each coil (C_p), measurements are performed for two connection schemes. One is shorted between P1 and S1, and between P2 and S2. The other is shorted between S1 and S2, and between P2 and S2. The circuits, seen looking into the primary coil (P1-P2), become simple resonant circuits with input impedances of Z_{no} and Z_{ns} for two schemes. Below the resonant frequencies, L and k are then written as

$$L = \frac{2|z_{no}|^2(2+c|z_{ns}|\omega+2c_p|z_{ns}|\omega)}{\omega(1+2c_p|z_{no}|\omega)(-|z_{ns}|+2|z_{no}|(2+c|z_{ns}|\omega+c_p|z_{ns}|\omega))},$$

$$k = \frac{-|z_{ns}|+|z_{no}|(2+c|z_{ns}|\omega)}{|z_{no}|(2+c|z_{ns}|\omega+2c_p|z_{ns}|\omega)}$$

(In this report, two resonant frequencies are higher than 10 MHz.) Comparing these equations with measurements gives the L and k of the transformer as shown in Fig. 3 and Fig. 4, respectively. The k is more than 0.986 below 9 MHz, and the leakage inductance, $(1-k)L$, is 0.32 μ H. The C and C_p are 31.5 pF and 6.01 pF, respectively. Using this transformer, the model system has been tested in the 2-6 MHz range.

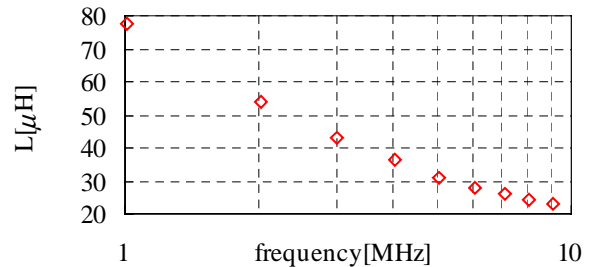

Fig. 3: Inductance of the isolation transformer

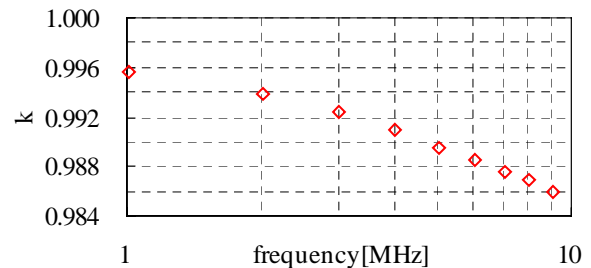

Fig. 4: Coupling coefficient of the isolation transformer

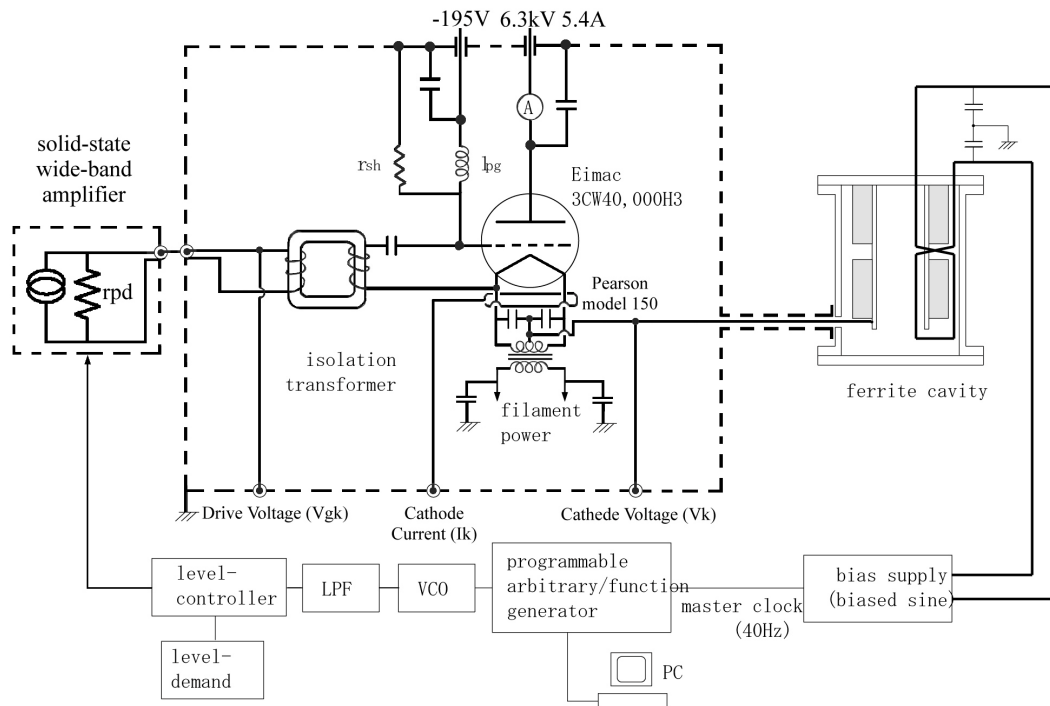

Fig. 5: Model RF system for wide-band low-power driver of the low output-impedance RF system

3 EXPERIMENTAL RESULTS

3.1 System Setup

Fig. 5 shows a schematic view of the model RF system. The bias power supply feeds a bias current for the load of ferrite-loaded cavity in a dc-biased sinusoidal waveform at 40 Hz repetition. The cavity is connected to the cathode of the Eimac triode (3CW40,000H3); the plate voltage is 6.3 kV and the quiescent current is 5.4 A. The transistor amplifier drives the tube between grid and cathode through the isolation transformer.

3.2 Output Impedance

A Hewlett Packard 4195A network/spectrum analyser is used to measure the output impedance. The probe is connected through a capacitor to the cathode. As the output impedance is dependent on the Z_{gk} in Eq. (1), the measurements are performed for the shunt resistor (r_{pd}) of 50, 150, and 300 Ω at each dc bias-current. Then, the output impedance is sampled at the corresponding resonant frequency of the load that comprises the cavity and the capacitance between coils of the filament transformer. The results are shown in Fig. 6 compared with calculations. A good agreement is obtained.

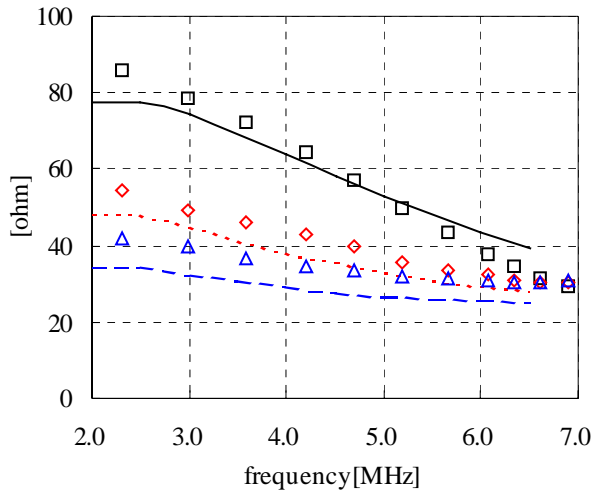

Fig. 6: Output impedance of the floating grid-cathode driving scheme at the shunt resistor (r_{pd}) of 50 (square), 150 (lozenge), and 300 (triangle) Ω . The solid, dotted and dashed lines show calculations at each resistor.

3.3 Voltage Gain

The voltage gain of the driver to the cavity is shown in Fig. 7. At a higher frequency, the gain decreases with

frequency due to the leakage inductance of the isolation transformer. At low frequency range, the measurements are higher than calculations.

In the calculations, a peaking structure can be seen. It is explained in terms of the series resonance, which is composed of the leakage inductance of isolation transformer and the C_{pg} , where the capacitance becomes $(1+\mu)$ -times larger by the Miller effect.

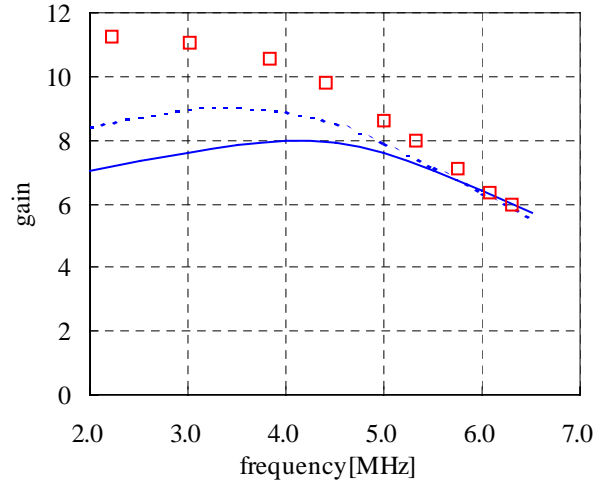

Fig. 7: Voltage gain of the driver to the cavity gap. Square shows the measurements. The solid and dotted lines show the calculations at 500 and 1500 Ω of the assumed cavity resistance, respectively.

4 DISCUSSION AND CONCLUSIONS

By utilising an isolation transformer to directly excite grid and cathode (floating grid-cathode driving), it is shown that the voltage gain is 6-11 over the frequency range 2-6 MHz. It should be noticed that such a high gain is realised in compensation for more current in the tube. However, by tuning the cavity to cancel the reactive current in the tube, the plate current can be minimised.

ACKNOWLEDGMENT

Discussions with Prof. K. Sato and Prof. S. Ninomiya are appreciated. The authors would also like to thank Prof. I. Yamane for continuous encouragements.

REFERENCES

- [1] Y. Irie and S. Takano, "Very Low Output-Impedance RF System for a Proton Synchrotron with Low Drive Power Requirements," *IEEE Trans. Nucl. Sci.*, vol. 46, pp. 1289-1293, Oct. 1999.