

APPLICATION OF HTS BI-2223 FOR CURRENT LEADS OF SUPERCONDUCTING MAGNETS

I. Bogdanov, S. Kozub, K. Myznikov, P. Slabodchikov,
V. Sychev, V. Sytnik, L. Vassiliev, V. Zubko
Institute for High Energy Physics, Protvino, Russia

I. Akimov, N. Gryaznov, D. Rakov, A. Shikov
Bochvar's Scientific Research Institute of Inorganic Materials, Moscow, Russia

Abstract

The most developed area of the using of high temperature superconductivity is for the moment the current leads, especially current leads assigned for superconducting magnets of particle accelerators. In this paper IHEP experience in this area is reported. The short description of 600 A current leads design is presented. Current leads were made on the base of composite tapes with Bi-2223 filaments both in Ag+1at.%Au and in Ag+10at.%Au matrices. Thermal and electrical properties of current leads were studied and obtained results are compared with the demands for LHC 600 A current leads. Current leads exhibit the high stability to the origination and development of quench.

1 INTRODUCTION

Heat leak through current leads makes significant contribution to heat load on cryogenic system of particle accelerators with large number of superconducting magnets. The decreasing of such heat leak can be accomplished with the use of HTS current lead. At CERN it is already accepted the solution to use the HTS current leads for the powering of superconducting magnets of LHC. To accomplish this the manufacturing of current leads with operating current in range 600–13000 A would require. At the moment the current lead prototypes are being studied intensively at CERN [1,2]. The proposal to change the copper current leads of Tevatron on more effective HTS current leads is developed at FNAL. According to this program the HTS current leads have already been made and tested [3].

Three 600 A HTS current leads were made and tested at IHEP in accordance to the CERN specification [4]. As a current carrying element the HTS conductor on the base of Bi2223 composition into the AgAu alloy matrix was used.

2 DESIGN FEATURES OF LEADS

Composite conductor consists of Bi2223 filaments embedded into AgAu alloy matrix. It is made on the base of powder $\text{Bi}_{1.8}\text{Pb}_{0.4}\text{Sr}_{2.0}\text{Ca}_{2.2}\text{Cu}_{3.0}\text{O}_x$ by the "powder in tube" method [5]. The content of Au was 1 and 10 atomic

percents. We used tape conductors with rectangular cross section, Table 1. Amount of Au significantly affects on HTS tape thermal conductivity. Temperature dependence of thermal conductivity is presented in Fig. 1. Within temperature range 4.2–50 K the thermal conductivity of HTS tape with Ag+1at.%Au matrix is approximately five times higher than the one for tape with Ag+10at.%Au.

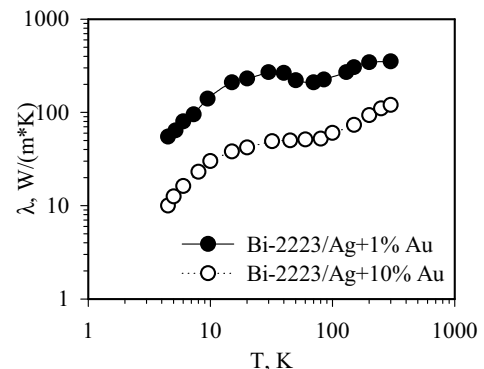

Figure 1: Temperature dependence of heat conductivity.

Temperature dependence of critical current of HTS tapes is shown in Fig. 2. While the temperature decreases down to 4.2 K critical current increases approximately by a factor of five. Critical current depends very strongly upon magnetic field. So, in the magnetic field of 0.05 T (self field in our design) at the temperature region 65–77 K critical current of those tapes decreases on 25–35%.

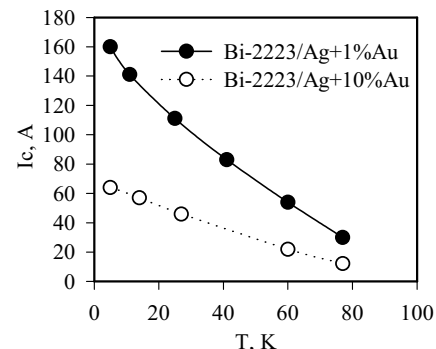

Figure 2: Temperature dependence of critical current.

The design of all current leads is similar. Leads consist of resistive and HTS parts and differ mainly by the number of tapes, see Table 1. Current lead #1 with 33 HTS tapes is schematically depicted in Fig. 3. Lead has the lug to connect to power supply and the sockets for helium gas cooling the resistive part.

This work was supported by CERN.

Table 1: Main design distinctions of current leads.

	Lead #1	Lead #2, #3
HTS conductor:		
Number of filaments	37	61
Material of matrix	Ag+10at% Au	Ag+1at% Au
Cross section, mm ²	4.3*0.25	4.6*0.25
Filling factor, %	30	30
Resistive part:		
Cu wire diameter, mm	0.13	0.13
Number of Cu wires	2300	2300
Tube inner diameter, mm	12	11
Packaging density, %	29	35
HTS part:		
Length, mm	350	400
Number of HTS tapes	33	16*
Tapes number in element	3	2*
Number of NbTi wires	1	2

* – current lead #3 has the third tape of 100 mm length on the upper end of each current carrying element.

Resistive part consists of copper wires, which are enclosed in stainless steel tube 500 mm in length. Bunch of copper wires is cooled by helium with T=20 K. The HTS part of current lead consists of HTS tapes placed by few at a time on facets of polyhedral stainless steel tube.

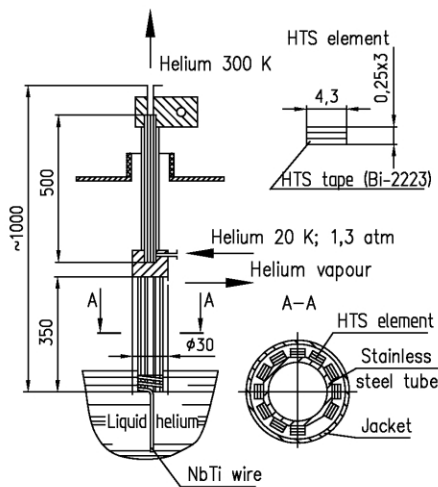

Figure 3: Sketch of current lead.

Upper and lower end elements of HTS part are made from copper. These elements are provided with right-angled slots for installation of HTS tapes. The spiral groove was made in the protruding parts for the placing of copper wire (upper end) or NbTi wires (lower end). These wires clamp the HTS tapes in slots and make easier the soldering. The length of joint is 20 and 30mm on upper and lower end correspondingly. Such design as well as the using of special solder provides the low value of transition resistance between HTS and NbTi conductors. Characteristics of NbTi wires provide the great current margin (>1000 A per wire at 4.2 K in magnetic field 6 T). The HTS tapes are cooled by the evaporated helium, which flows through the annular gap between HTS tapes

and outside protective stainless steel jacket. The lower end of HTS part is located into liquid He.

3 MAIN TESTS RESULTS

For the tests of leads the special-purpose test facility has been created [6]. Inlet helium temperature and mass flow rate were measured and operated automatically. The leads were equipped with potential taps and thermometers.

Calculated and measured temperature profiles on HTS part at 600 A are presented in Fig. 4. According to the measured temperature profile the heat load into the liquid helium was calculated. Obtained results are presented in Table 2 for operation at currents 600 A with nominal helium flow and at 0 A with 0.6 of nominal helium flow.

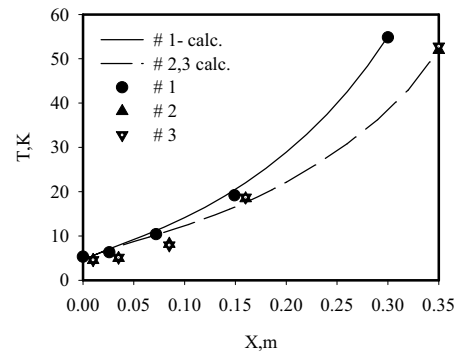

Figure 4: The temperature profile along HTS part.

Voltage on the resistive part at 600 A and resistances of joints are presented in Table 2. It is evident that due to careful choice of solders and joint design the resistance R_w between HTS and resistive parts and resistance R_c between HTS and NbTi conductors have the low values.

In Fig. 5 the voltage-current characteristics of HTS parts of current leads are presented. Those dependences were obtained at temperature of HTS warm end ≈ 50 K and nominal He mass flow at current ramp rate ≈ 300 A/s.

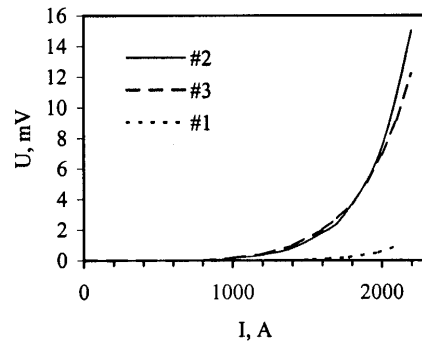

Figure 5: Voltage-current characteristics of leads.

During the current overloading the temperature increased not more than a few Kelvin. Such thermal inertia of upper joint of HTS part is the direct verification of high reliability of current leads at short-term current overloading. Current leads continuously and stably operated at 600 A at temperature of HTS upper end of 60 K. In this case when the equilibrium state was achieved then the main lead parameters were invariable.

Table 2: Main parameters of HTS current leads.

Parameter:	Design value	Lead #1	Lead #2	Lead #3
Nominal mass flow of 20 K He at 600 A, g/s	≤ 0.04	0.03	0.04	0.04
Pressure drop of 20 K He flow, kPa	≤ 5	1.0	5.0	5.0
Heat load at liquid He at 600 A, mW	< 80	42	130	125
Heat load at liquid He at 0 A, mW	< 70	42	140	135
Voltage on resistive part at 600A, mV		58	76	72
Contact resistance R_w , n Ω	< 1000	130	220	250
Contact resistance R_c , n Ω	< 30	1.4	2	3

For initiation of HTS part transition of lead carrying 600A the flow of 20 K He was interrupted. About hundreds seconds it turns to be necessary to change significantly the temperature of the warm HTS end. For the current lead #1 voltage drop on HTS part increased from 0 up to 55 μ V and stabilized at this level. This value more than two orders of magnitude lower than 10 mV that is considered as quench beginning. Current lead operated stable and temperature of upper end of HTS part was equal of 69 K. In Fig. 6 the progress of similar process for the current lead #2 is shown. After the interruption of 20 K He flow the voltage on the HTS part increased up to 0.6 mV and temperature of upper end of HTS part reached 87 K during the time near 1000 s.

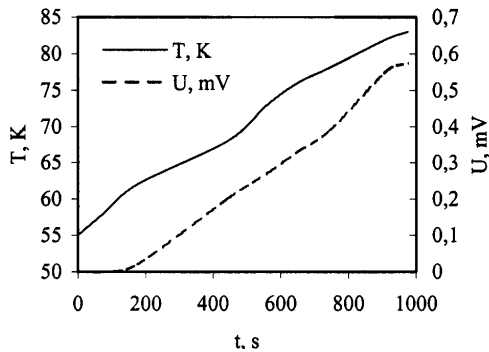

Figure 6: Behaviour of HTS part of current lead #2 after the interruption of cooling gas flow.

With the aim to reach on HTS part the voltage of 10 mV we repeated test but in addition to He flow interruption we used heater mounted on upper end of HTS part. Result is shown in Fig. 7. In this case the most remarkable is the fact that after the detection of quench (voltage of 10 mV was reached) nominal current continued to flow during

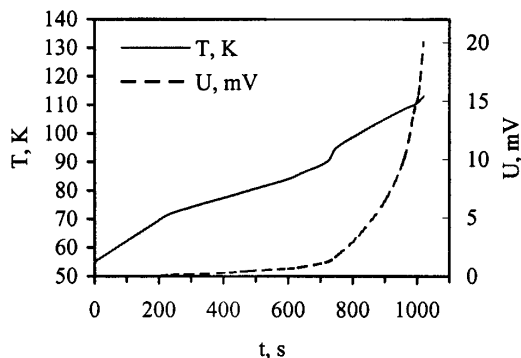

Figure 7: Behaviour of current lead #2 with additional heating of upper end of HTS part by heater.

one minute instead of 10 second in accord with specifications. Thereafter no noticeable damages or changes of lead properties were found.

At the decreasing of liquid helium level below cold end of HTS part on 20 mm at 600 A the change of parameters of lead was not observed at least during the initial ten minutes. The cooling of cold end of HTS part is likely executed by the thermal conductivity through the NbTi wires, which continued to reside into liquid He bath.

4 CONCLUSION

The tests showed high reliability of current leads and its agreement to specification by the most parameters. Leads operate very stable at the increasing of HTS warm end temperature up to 60 K. Electrical properties of lead are excellent. Contact resistances are significantly lower than acceptable. Heat load through lead #1 is significantly lower than the allowable value. Heat load through leads #2 and #3 is higher than 80 mV. But due to high current margin the possibility exists to decrease the heat load by diminution of total THS tape number and by using HTS current carrying elements with the varying by length cross section. At the moment such work is underway.

REFERENCES

- [1] A.Ballarino, "High Temperature Superconducting Current Leads for the Large Hadron Collider", ASC-98, IEEE v.9, 1999, pp.523-526.
- [2] A.Ballarino, L.Serino, "Test Results on the First 13 kA Prototype HTS leads for LHC", Proc. of the 1999 Particle Accelerator Conference, New York, USA, 1999, pp.1405-1407.
- [3] G.Citver, S.Feher, P.J.Limon et al. "HTS power lead test results", Proc. of the 1999 Particle Accelerator Conference, New York, USA, 1999, pp 1420-1422.
- [4] Technical specification for the fabrication and supply of prototype 600 A current leads using high temperature superconductor. IT-17847/LHC/LHC, Geneva, Switherland, July 1998.
- [5] I.I.Akimov, N.I.Kozlenkova, P.A.Kuznetsov et al. "Properties of Bi-2223/(Ag+Au) Tapes", Proc. of XVI Conf. on Magnet Technology, Tallahassee, USA, 1999.
- [6] I.V.Bogdanov, S.S.Kozub, K.P.Myznikov et al. "Design and Test of High Temperature superconductor Current Lead", Proc. of XVI Conf. on Magnet Technology, Tallahassee, USA, 1999.