

OPERATIONS OF THE SERSE SUPERCONDUCTING ECR ION SOURCE AT 28 GHz

S. Gammino, G. Ciavola, L. Celona, P. Romano, L. Torrisi INFN-LNS, Catania, Italy
D. Hitz, A. Girard, G. Melin, CEA-DRFMC-SBT, Grenoble, France

Abstract

The SERSE source has been efficiently working at the Laboratori Nazionali del Sud in Catania since 1998, by operating at 14 and 18 GHz, with a maximum power of about 2 kW. The performance of the source has been optimised for the beam injection into the K-800 Superconducting Cyclotron, i.e. the maximisation of the charge states was looked for, provided that the current of the beam was about 0.5 to 5 μA , which is the typical analysed current for routinely operations.

In 2000 a collaboration was established in order to test the behavior of SERSE at 28 GHz, so that a new operating domain could be studied, featuring a very dense plasma (up to 10^{13} cm^{-3}) and a very high ion current (1 $\text{e}\mu\text{A}$ of Pb^{27+} is the goal of CERN and GSI for future heavy ion projects and 0.5 $\text{e}\mu\text{A}$ was considered to be a challenge for our experiment).

Tests were carried out with a generator based on a gyrotron tube which was refurbished and made available by CEA; Xenon ions were chosen as a reference being the ionisation difficulty for Xe^{20+} similar to the one of Pb^{27+} .

The results were excellent and the current of Xe^{20+} exceeded our expectations (more than 0.5 $\text{e}\mu\text{A}$ in afterglow and about 0.3 $\text{e}\mu\text{A}$ in dc mode). These results, obtained with a power limited to 4 kW in dc mode and 6.5 kW in pulsed mode because of the poor chamber cooling, can be considered as a remarkable step, in view of the third generation of electron cyclotron resonance ion source (ECRIS).

The details of the experiments will be described, along with the design of the next superconducting ECRIS, the GyroSERSE source, which is expected to produce beam currents above 1 mA for intermediate charge states as well as very high charge states, 50^+ to 60^+ for the heaviest ions, with currents above 1 μA .

1 INTRODUCTION

Under the frame of a collaboration between CERN - Geneva, GSI - Darmstadt, CEA - Grenoble, ISN - Grenoble and INFN - LNS, a research program was established in order to produce very intense beams with an ECRIS [1]. The idea was to increase the electronic density n_e of an ECRIS by using a frequency heating higher than the typical 6.4, 10, 14 or 18 GHz commonly used in an ECRIS. The 28 GHz frequency was chosen, which should increase n_e by a factor 2.4 as compared to

the 18 GHz operation. However, the maximum "effective" mirror ratio R of SERSE should be, in that case, reduced from 2.4 at 18 GHz down to 1.6 at 28 GHz. The "effective" mirror ratio R is defined as $R = B_{\text{max}}/B_{\text{res}}$, where B_{max} is the value of the magnetic field at the mirror throat and B_{res} is the magnetic field at the resonance (1 T at 28 GHz). By changing R from 2.4 to 1.6, the electron confinement was lowered, but the tests of SERSE at 28 GHz permitted to obtain the highest currents ever achieved for any Xenon charge state above 20^+ by means of the higher plasma density.

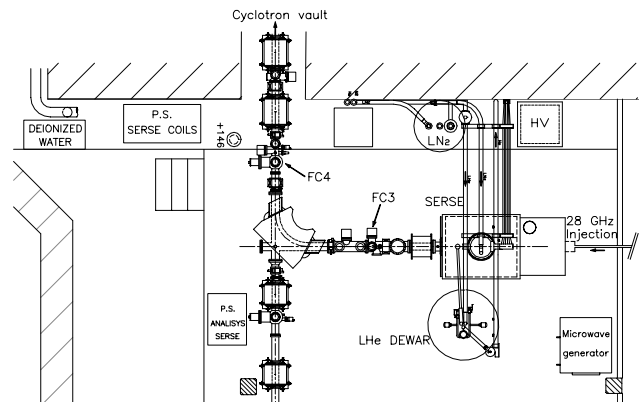

Figure 1: The analysis section of the SERSE beamline, including the focusing solenoid and the analyzing magnet.

2 THE EXPERIMENTAL SETUP

The experiment was carried out by using the SERSE source and its analyzing magnet (fig. 1). Ion currents were at first measured on the Faraday Cup FC3 in order to get the most of the extracted beam. Analyzed beam currents are measured by the Faraday cup FC4 located at the image point of the magnet, immediately after the ± 10 mm slits.

No major changes were made to the SERSE source [2,3]. The source injection flange was modified to include a window for high power 28 GHz microwave injection. The flange also included a window for 18 GHz microwave injection in order to allow comparison between the two modes of operation. The main difference with respect to the standard flange consisted of the biased disk which was fixed and this was perceived to be a limiting factor. The extraction gap was shortened in order to get the maximum current from the 12 mm extraction hole, but the extraction optics was not changed.

The extraction voltage was limited to 26 kV and most of the tests were carried out at 20 kV.

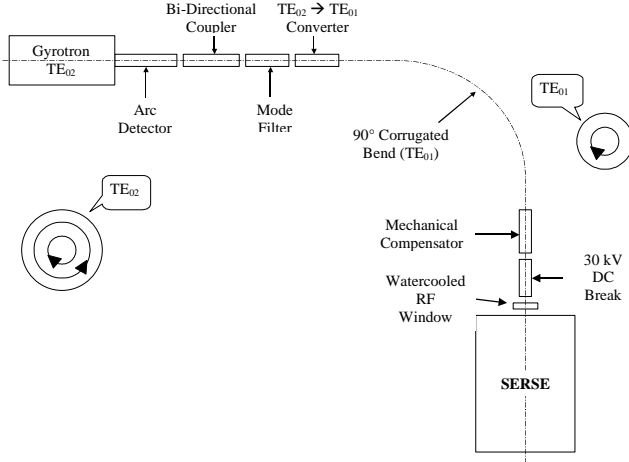

Figure 2: The waveguide line.

2.1 Microwave coupling

The microwave power from a gyrotron has been coupled to SERSE through the waveguide line described in fig. 2. The output mode of the 28 GHz - 10 kW gyrotron was TE_{02} ; a conversion into TE_{01} was performed to minimize ohmic losses, then oversized circular waveguides were used. The gyrotron itself was protected by an arc detector and a mode filter (the gyrotron does not suffer, as reflected power, more than 10% of the incident power). Mechanical compensators were used to prevent from any thermal expansion. A 90° bend with corrugated walls was used and a dc break was placed just before the source to insulate the waveguide up to 30 kV; then a water cooled sapphire window was used to insulate the waveguide from the vacuum. A bidirectional coupler, calibrated with a water-load, measured the incident and reflected power in the TE_{02} mode. During the tests the maximum observed reverse power was less than 150 W, which enabled a safe operation of the gyrotron. The line was about 8 m long and, when 10 kW were extracted from the gyrotron, the losses in the rf line were about 400-500 W, most of the losses (300 W) being in the mode filter. Being 700 mm of the line under vacuum a resonance occurred in the waveguide, inducing a plasma; this phenomenon lasted a few hours during the waveguide outgassing. In conclusion, the rf launching into Serse was successful, and it is an important achievement, considering that it is the first time that 28 GHz microwaves have been coupled to an ECR ion source.

3 SCALING EFFECTS AT 28 GHZ

We have remarked in a previous paper [4] that the Geller's semi-empirical scaling laws [5] are able to explain the results of many existing ECR sources, even if they do not represent the ECRIS behavior exhaustively; two laws are particularly relevant to our tests:

$$P_{rf} \propto V \omega^{1/2} q_{opt}^3 \quad (1)$$

$$I^{q+} \propto \omega^2 M_i^{-\alpha} \quad (2)$$

where q_{opt} is the optimal charge state, P_{rf} is the microwave power, $\omega = 2\pi f$, I^{q+} is the intensity of the charge state q , M_i is the ions mass and α is an adjustable parameter variable between 0.5 and 1.

It was demonstrated at lower frequency [6,7,8] that the scaling laws and in particular eq.(2) are effective only if the confining field is high enough to support a higher electron density.

The conclusions of the scaling laws tests at frequencies between 2.45 and 18 GHz [4,9] were the following:

- the ratio between the radial field and the resonance field should be higher than two;
- the axial field at the injection side must be as high as possible, in order to close the loss cone;
- the axial field at the extraction side should be optimized around the value of the radial field, so that the escape of plasma on the wall is not favored with respect to the beam extraction;
- the frequency should be increased, provided that a high magnetic confinement is maintained;
- the CSD improves with the microwave power, but the amount of power that can be coupled to the plasma increases with the confining field.

It was shown in ref [9] that the increase of current obtained with SERSE by increasing the frequency from 14.5 to 18 GHz is at least proportional to $(f_2/f_1)^2$, once that the magnetic field is scaled by a factor f_2/f_1 .

The increase for the highest charge states was even more relevant than expected according to the f^2 law. In fact for the highest charge states of xenon the increase was up to a factor 4 [9].

Fig. 3 compares the Xe^{27+} intensities extracted from SERSE at three different frequencies and for a different radial field. It is clear that the performance of the source is improving with the increase of radial field and that a net increase of the highly charged ion beam current is obtained by increasing the frequency. We arrived at the same conclusion when changing the axial field; the statements above cited [4,9] are confirmed even at 28 GHz, i.e. the higher is the field the better the performance.

A complete report of the study of dependence on the magnetic field and frequency may be found in ref [10].

4 PRODUCTION OF INTENSE BEAMS

The study for the production of Xenon ions with charge states $q \geq 20$ was carried out either in dc mode and in pulsed mode. In both cases the reproducibility of the results was excellent but the long term stability was not, mainly because of technical problems (outgassing, high voltage discharges), especially in the case of a poorer confinement of the plasma. Because of outgassing the power was limited to 3 kW in dc mode (except for a short test at 4 kW) and to 6.5 kW in afterglow mode. The dependence of Xe^{20+} intensity on the microwave power

was about linear up to 3 kW then it saturated and decreased above 3.5 kW because of outgassing; on the other way in pulsed mode there was not an optimum but a continuous beam current increase with the power was observed.

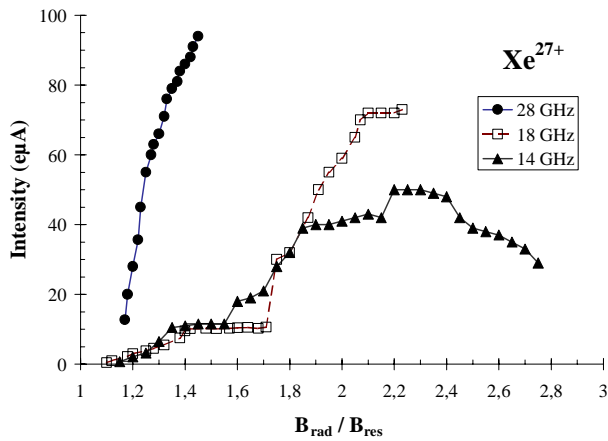

Figure 3: Xe^{27+} currents obtained by operating SERSE at different frequencies versus increasing radial field (20 kV extraction voltage).

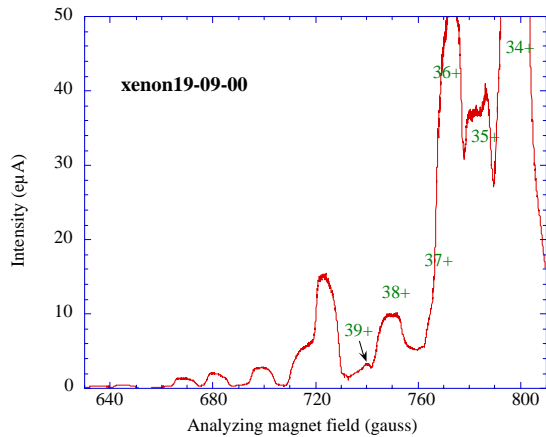

Figure 4: High charge states spectrum (power=4 kW).

The performance for the highest charge states had a similar trend and for ions like Xe^{30+} and Xe^{33+} the increase of current with the power was steeper between 3 and 4 kW. During a short test devoted to the optimization of the high charge states production in dc mode, a higher power and a very low amount of gas were injected, and a few charge states were optimized at power level above 4 kW. In spite of the relatively high pressure inside the plasma chamber ($\sim 2\div 3 \times 10^{-7}$ mbar), we observed about 100 eµA of Xe^{30+} , about 8 eµA of Xe^{38+} and 0.5 eµA of Xe^{42+} .

Unfortunately these levels could not be maintained for a long time and after a few minutes they decreased by a factor two or more, but anyway they confirm that a remarkable increase can be obtained by operating ECRIS at 28 GHz. In fig. 4 the section of the spectrum featuring the highest charge states for Xenon is reported. An accident to the plasma chamber which was damaged by

electron bombardment obliged us to stop these tests and in the following days we have operated the gyrotron only in pulsed regime.

4.1 Afterglow mode

The current of Xe^{25+} measured on FC4 is shown in fig.5. It can be observed that the enhancement factor was about 1.5 or 2 with respect to the yet larger current obtained in dc mode. It must be remarked that it was not possible to extract larger currents because of the limited current available from the high voltage supply (the drain current was 15 mA, three times bigger than the current measured on the Faraday Cup FC3, because of the backstreaming electrons from the puller and because of the beam losses in the extractor and in the first part of the beam line).

In fig. 6 the performance of the source in dc mode and in afterglow mode are compared. It must be noticed that the optimum trap for dc mode production is the optimum also for the afterglow mode.

The results concerning the peak stability were less good than at lower frequency, when the source operates in High B mode, but it is still acceptable for most of applications, being about $\pm 10\%$.

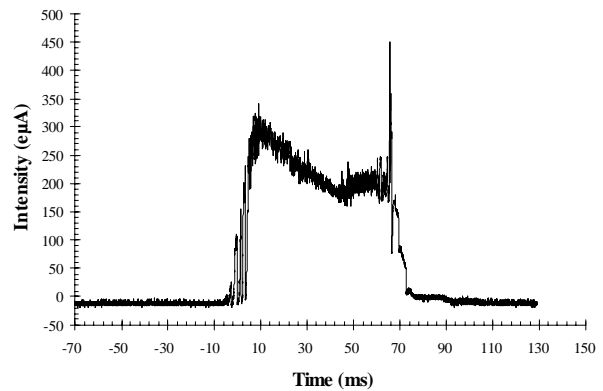

Figure 5: A Xe^{25+} beam pulse in afterglow mode.

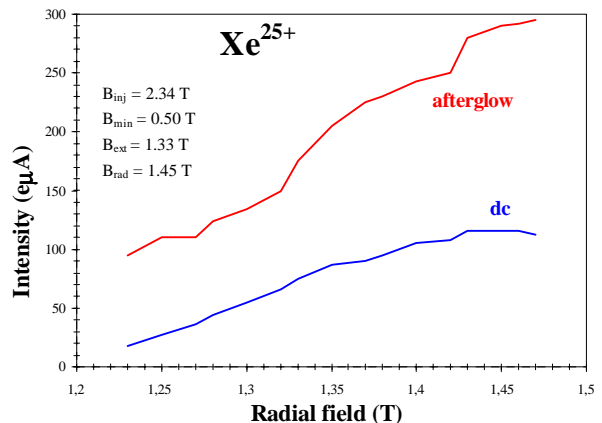

Figure 6: Comparison of Xe^{25+} currents in dc and afterglow mode versus the radial confining field.

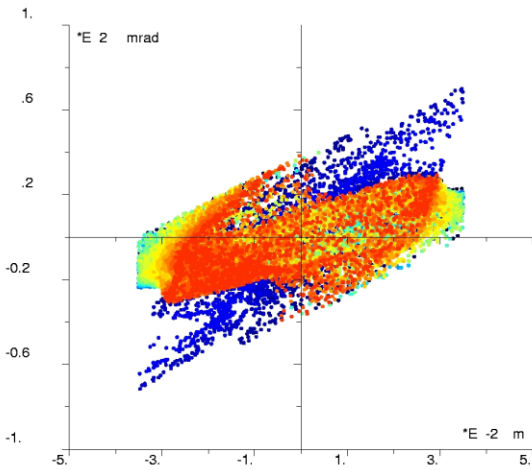

Figure 7: Emittance plot for Xenon beams.

5 TECHNICAL PROBLEMS

5.1 High voltage discharge and extraction process

High voltage sparks often occurred because of the high gas load which was needed to optimize the production of intense beams. A further load derived from the beam divergence: we carried out the tests with the same extraction system which we optimized for the low current, low emittance beams used for the injection into the cyclotron and it seemed to be not appropriate. In fig. 7 a simulation is shown, which features a very large beam emittance (about 500 to 900 π mm.mrad for the typical total current of 4 to 15 mA from the extractor [11]) whereas the acceptance of the analysis beamline is about a factor five smaller. The large emittance led to relevant beam loss either between the extraction and FC3 (the beam pipe became warm after a few hours of operations in dc mode) and between the two Faraday cups (we evaluated the loss in this case and we estimated that about 35% of the beam is lost inside the analyzing magnet, whose gap is only 54 mm).

The beam losses at the extraction are also important, as it is evident in fig. 8, where the typical triangular shape of the beam on the puller is visible; this losses generated an important outgassing which further increased the gas load and finally damaged the plasma electrode, which was melted (fig. 9). In spite of these troubles, we were able to find a suitable set of parameters which permitted us to complete the tests with a safe regime for electrodes.

5.2 X-ray and LHe consumption

The high flux of X-ray which we measured around the source was generated by the electrons lost on the chamber wall, because of the insufficient plasma confinement.

In fig. 10 the X-ray measurements in the radial direction at 18 and 28 GHz are compared (the source

setting was similar in the two cases). The energy distribution was not much different at 28 GHz, but a low energy population is also present. The X-ray level in the radial direction is much higher at 28 GHz, which is a hint of the bad confinement (in fact on the axis, the level of radiation measured during 28 GHz operations was not higher than the one which we measured at 18 GHz).

A further evidence of this intense X-ray bombardment consisted of the higher LHe consumption which was associated with the lower radial magnetic field. The LHe consumption increased from 4.5 to 10 l/h and because of this effect and because of the plasma instability we could not decrease the radial field below 1.17 T in our test of scaling laws [10]. In fact the energy release in the cryostat decreased the safety margin of the magnets and we got quenches which were caused by the X-ray bursts, in spite of the magnet setting, which was considered safe.

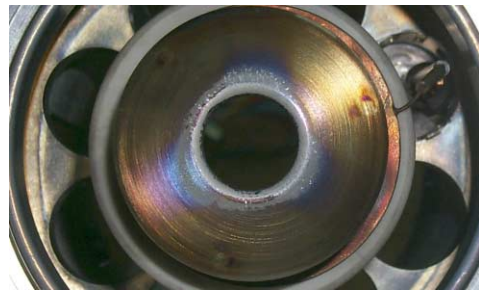

Figure 8: A picture of the puller

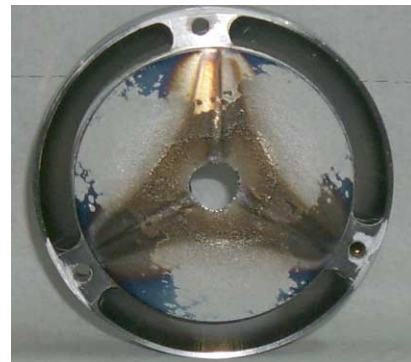

Figure 9: A picture of the eroded plasma electrode

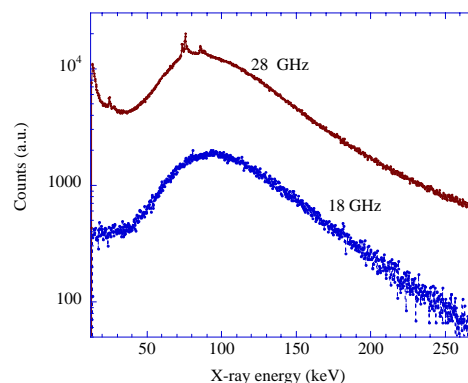

Figure 10: Comparison of the X-ray emission rate.

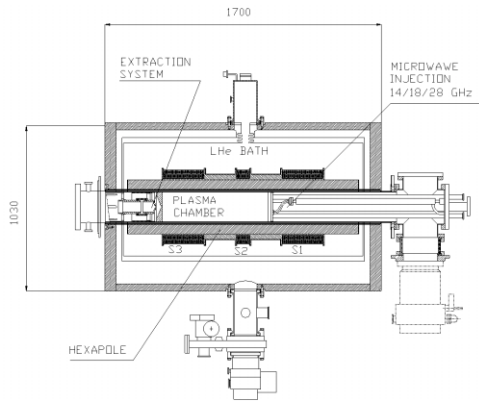

Figure 11: A sketch of the GyroSERSE source.

6 THE GYROSERSE PROJECT

The successful completion of the study of SERSE at 28 GHz reinforced our intention to build the GyroSERSE source [2,12]. This source is designed to operate in high-B mode at a frequency equal or higher than 28 GHz, getting a hot dense plasma (10^{13} cm^{-3}).

The main features of this design compared to the ones of SERSE are given in tab. 1. Fig. 11 shows a sketch of the GyroSERSE source, with the cryostat, the solenoids and the hexapole surrounded by an iron yoke.

The mechanical constraints have obliged to choose a well larger inner bore than for SERSE, because of the boundary conditions for the hexapole (the stored energy is above 300 kJ). The warm bore thickness corresponds to an internal diameter of the plasma chamber of 180 mm, 50 mm larger than the one of SERSE. The maximum field in the conductor is about 7.5 T. The length of the plasma chamber will be about 700 mm and the volume will be larger than 14 liters, well higher than any other existing source. The large diameter will help to get a pressure in the order of 10^{-8} mbar inside the chamber and will make easier the design of the injection flange that will host the ports for 14, 18 and 28 GHz injection, two gas inputs and a 35 mm flange for the oven, the biased disk, the sputtering system or the target for laser ablation.

On the outer side a 5 mm double wall watercooled stainless steel chamber will be able to dissipate a maximum power of 10 kW. On the outer a 3 mm thick PEEK tube will insulate the cryostat (at ground) from the chamber (at 40 or 50 kV). The extraction system will be further studied [11]. In conclusion, this source seems to be feasible and not more expensive than SERSE, as many components will be inspired by the design of SERSE. An estimate of the time involved with the completion of such a source has been roughly carried out, and we believe that 3.5 years from the date of funding (expected for the summer 2001) are needed.

ACKNOWLEDGMENTS

This work has been performed under the frame of a collaboration of CEA/DRFMC/SBT with GSI/Darmstadt

(N.Angert, P. Spädtke, K. Tinschert), CERN (C. Hill, H. Haseroth), ISN/ Grenoble (P. Sortais) under contract # K 598/PS and in the frame of a Memorandum of Understanding between CEA and INFN/LNS. We acknowledge the support of the European Community – Access to Research Infrastructure action of the Improving Human Potential Programme.

The precious help of F. Chines, S. Marletta, E. Messina, J. Debernardi, J.M. Mathonnet during the experiment has been appreciated.

We gratefully thank P. Spadtke for the simulations of the extraction process.

Table 1: Comparison between the design features of SERSE and GyroSERSE.

	SERSE	GyroSERSE
f	14-18 GHz	28-35 GHz
B_{radial}	1.55 T	2.7 T
B_1	2.7 T	4.5 T
B_2	1.6 T	3.5 T
ϕ_{chamber}	130 mm	180 mm
L_{chamber}	550 mm	700 mm
ϕ_{cryostat}	1000 mm	~1000 mm
L_{cryostat}	1310 mm	1540 mm
V_{extr}	20-25 kV	40-50 kV
Lhe consumption	~4l/h (100 l/day)	0
O^{8+}	~7 pμA	~50÷100 pμA
Ar^{18+}	>20 pμA	~1 pμA
Au^{45}	~1 pμA	~0.1 pμA
Xe^{42+}	----	~.02 pμA
Pb^{52+}	----	~.01 pμA

REFERENCES

- [1] N. Angert et al., Proc. of the 14th Int. Workshop on ECR ion sources, Geneve, (1999) 220
- [2] S. Gammino and G. Ciavola, Rev. Sci. Instr. 71(2), (2000) 631
- [3] G. Ciavola and S. Gammino, Rev. Sci. Instr. 63(4), (1992) 2881
- [4] S. Gammino, G. Ciavola, Proc. of 14th Int. Conf. on Cyclotrons & Applications, Capetown, Sudafrica (1995) 377
- [5] R. Geller et al, Proc. of the 8th Int. Workshop on ECR ion sources, East Lansing, (1987) 1
- [6] G. Ciavola and S. Gammino, Plasma Sources Science and Technology, 5 (1996) 19
- [7] T. Antaya and S. Gammino, Rev. Sci. Instr. 65(5), (1994) 1723
- [8] S. Gammino et al., Rev. Sci. Instr. 67(12), (1996) 4109 and references therein
- [9] S. Gammino et al., Rev. Sci. Instr. 70(9), (1999) 3577
- [10] S. Gammino et al, submitted to Rev. Sci. Instr., 2001
- [11] P. Spadtke, private communication (2001)
- [12] S. Gammino, G. Ciavola, L. Celona, The GyroSERSE project, Proc. Workshop "Production of Intense Beams of Highly charged ions", Catania (2000), to be published by Società Italiana di Fisica, Bologna, Vol. 72 (2001)