

ORBIT COMPENSATION FOR THE TIME-VARYING ELLIPTICALLY POLARIZED WIGGLER WITH SWITCHING FREQUENCY AT 100 HZ

O. Singh and S. Krinsky
NSLS, Brookhaven National Laboratory

Abstract

In October 1996, the elliptically polarized wiggler, installed in the X13 straight section of the NSLS X-ray ring, was commissioned at an operating frequency of 100 hz. This wiggler generates circularly polarized photons in the energy range of 0.1 to 10 keV with AC modulation of polarization helicity. The vertical magnetic field is produced by a hybrid permanent magnet structure, and the horizontal magnetic field is generated by an electromagnet capable of switching at frequencies up to 100 hz. Here, we discuss the compensation of the residual vertical and horizontal orbit motion utilizing a time-domain algorithm employing a function generator to drive trim coils at the wiggler ends, and the wideband high precision orbit measurement system of the X-ray ring. The residual orbit motion has been reduced to a level below 1 micron, and the device has been run in regular operations with no negative effect on other users.

1 INTRODUCTION

The time-varying elliptically polarized wiggler [1, 2, 3] was installed in the X13 straight section of the NSLS X-ray ring in December 1994. This device produces variable polarized x-rays, with the right- /left- handedness of polarization switchable at up to 100Hz, making possible the use of gating or lock-in amplifier techniques to detect the very weak signatures of circular dichroism and other effects associated with right- vs. left- handedness of some physical and biological systems. The DC vertical magnetic field is produced by a hybrid permanent magnet wiggler, and the time-varying horizontal magnetic field is generated by an AC electromagnet wiggler. Critical to the successful operation of the high degree of orbit stability required by the many experimental beamlines on the X-ray ring. Orbit compensation of the time-varying elliptically polarized wiggler operating at 2Hz was described in ref. 4. Here, we discuss the compensation of the residual orbit motion for 100Hz operation, utilizing a time-domain algorithm employing a function generator to drive the trim coils at the wiggler ends.

2 COMPENSATION METHOD

Our approach for 100 hz compensation consists of several steps: 1) measure orbit distortion in time-domain at two pick-up electrodes (pues) with electromagnet switching at 100 hz, 2) process these waveforms to remove offsets and add gains, 3) load processed waveforms into function generators which produce correction signals in synchronism

to switching frequency, 4) apply correction signals to end trims and observe the frequency spectrum of residual distortion at the switching frequency and its harmonics. Fig.1 shows the block diagram for the dynamic compensation system

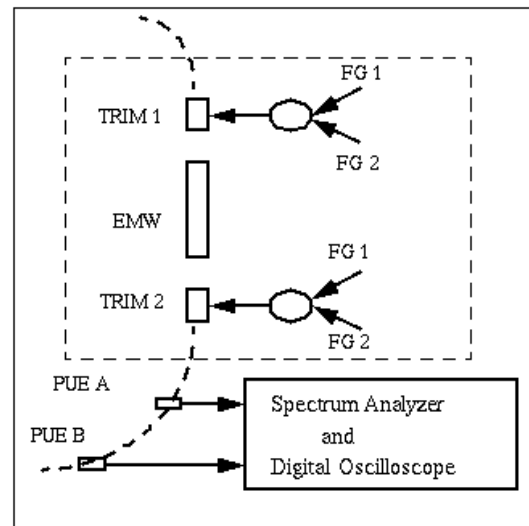

Figure 1: Dynamic Compensation System.

2.1 Time-domain orbit distortion measurement

A fast digital oscilloscope (LeCroy 9354) is used to measure orbit distortion. This oscilloscope is set up to sample at 1 Mhz and to collect 10,000 data points for every frame of 10 msec. Each frame's data is averaged point-to-point over several hundred frames. The averaging is critical to obtain an accurate time-domain orbit distortion because it removes ambient background motion. The dominant spectral content of the ambient orbit motion lies in the frequency range of 8 hz to 60 hz [4] and is cancelled by averaging. Figs. 2b and 2c show the uncompensated orbit distortion in the vertical and horizontal planes produced by the wiggler, in relationship to the driving wiggler current waveform shown in Fig. 2a. The level of distortions are 30 and 60 microns peak to peak in vertical and horizontal planes, respectively.

2.2 Signal processing

The measured average orbit distortion waveforms are transferred (off-line) to a PC based computer. The computer processes these waveforms to null for the offset in the orbit and to amplify the orbit waveform amplitude to provide sufficient correction trim signal level.

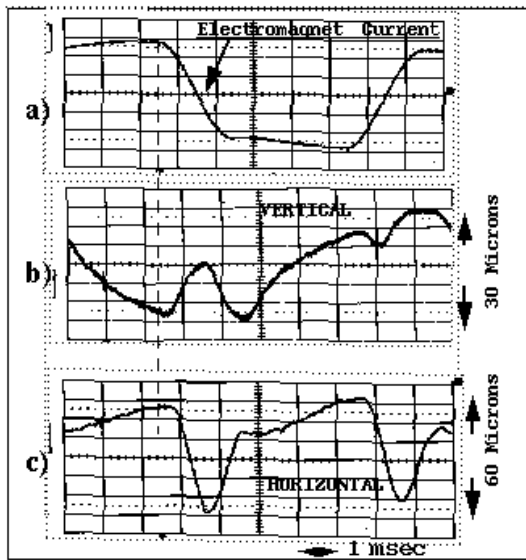

Figure 2: Waveforms with EPW (uncompensated) switching at 100 Hz with 400 amperes amplitude; (a) Current waveform (b) Vertical orbit distortion at pue A and (c) Horizontal orbit distortion at pue A.

2.3 Function generators

The output waveforms are loaded into function generators (Fluke 5150). These function generators provide 10 msec long correction signals at every 100 Hz trigger. Fig. 3 shows a set-up diagram utilizing four function generators, two for each plane. Note that the phase of each waveform can be adjusted by varying 100 Hz trigger delays (D1 to D4) to the function generators.

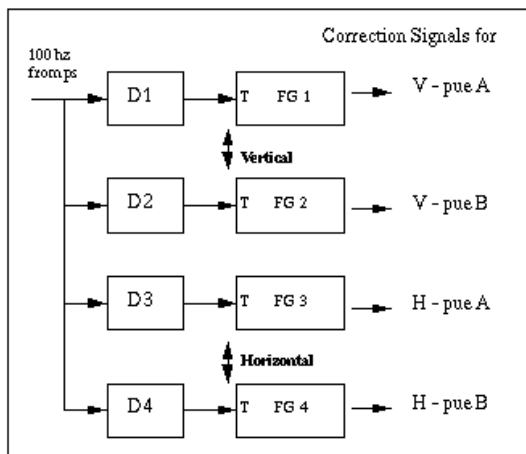

Figure 3: Function generators set-up with trigger delay units

2.4 Compensation

The spectrum analyzer was set to observe peaks at 100 Hz and harmonics. Each correction signal, which corresponds to a given pue, is applied to the end trims in a linear combination to correct orbit at that pue while leaving other pue

unchanged. While minimizing 100 Hz line spectral amplitude, we noticed that harmonic line spectra amplitudes did not reduce. In fact, there was an increase in amplitude of some harmonics. This is due to the fact that the trim-to-pue response is not flat, see Fig. 4.

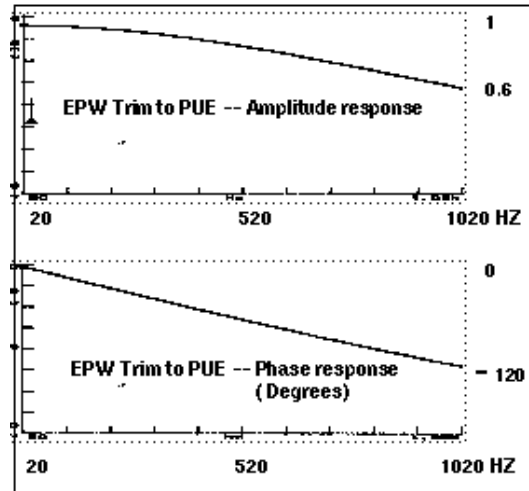

Figure 4: EPW trims to pues response.

For proper compensation, a new time-domain correction signal must be determined which takes into account the trim-to-pue response. In our approach, we determined this waveform by iteration, where each iteration minimizes the amplitude of only a few harmonics. Two iterations were sufficient to reduce the orbit distortion to a satisfactory level. The steps involved for compensation are discussed below. Let the first correction waveform be denoted by F_1 , shown in Fig. 5a, which is a measured distortion waveform. During the 1st iteration, this waveform is loaded into the function generator and the line spectra's magnitude at 100 and 200 Hz are minimized by adjusting amplitude and phase of the correction waveform. The optimized correction amplitude and phase are denoted by A_1 and P_1 . So, the optimized waveform is given by $(A_1 F_1$ with phase delay P_1).

With this correction, the residual orbit distortion F_2 is measured (Fig. 5b), and F_2 is now the new function for the 2nd iteration correction. In this iteration, the magnitude of the spectral lines at 300 to 600 Hz are minimized and the optimized correction amplitude is A_2 and phase delay is P_2 . The two optimized correction waveforms are combined in the computer to generate the final correction waveform $(A_1 F_1$ with phase delay P_1) + $(A_2 F_2$ with phase delay P_2). Fig. 5c shows the final residual orbit. No further iteration was necessary. The orbit distortion in frequency domain without compensation is shown in Fig. 6a; the distortion after 1st iteration is shown in Fig. 6b (note 100 and 200 Hz peaks are reduced); and the distortion after 2nd iteration is shown in Fig. 6c (note all peaks are minimized). In time-domain, as shown in Fig. 5, the vertical orbit distortion was reduced from 30 to 4 microns peak to peak (compare Figs. 5a to 5c). In frequency domain, 100 Hz ver-

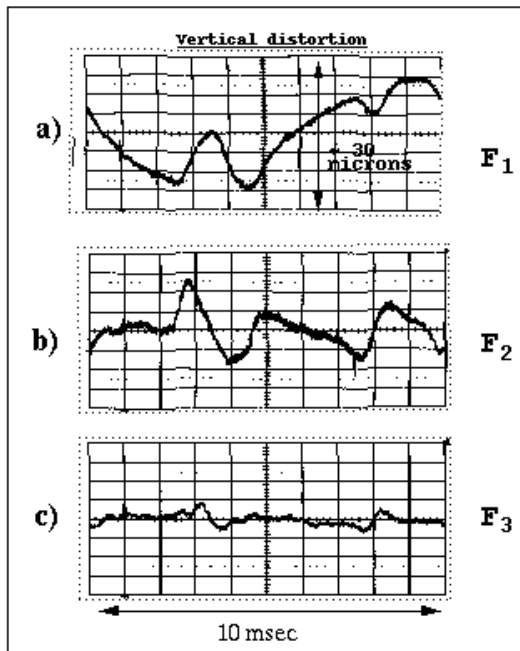

Figure 5: Time domain vertical orbit distortion when EPW switching at 100 Hz: (a) no compensation (b) 1st iteration compensation and (c) 1st and 2nd iteration compensations. Vertical distortion is reduced from 18 to 1.2 microns peak to peak (compare Figs. 6a and 6c). Compensation results for horizontal plane are shown in Figs. 7a and 7b without and with compensation, respectively.

3 ACKNOWLEDGEMENTS

We would like to acknowledge work done by H. Link and G. Frisbie for evaluating and programming efforts in the function generators. We would also like to acknowledge the collaboration with P.M. Ivanov and E.A. Medvedko in the early stages of this work. Work performed under the auspices of the U.S. Department of energy undercontract DE-AC02-76CH00016.

4 REFERENCES

- [1] A. Friedman, S. Krinsky, and E. Blum, "Polarized Wiggler for NSLS X-Ray Ring: Design Consideration," Informal Report BNL - 47317, March, 1992.
- [2] A. Freidman, X. Zhang, S. Krinsky, E. Blum and K. Halbach, "Polarized Wiggler for NSLS X-ray Ring", Proc. 1993 Part. Accel. Conf., Washington, D.C., May, 1993, p. 1599.
- [3] E. Gluskin, D. Frachon, P.M. Ivanov, J. Maines, E. A. Medvedko, E. Trakhtenberg, L. R. Turner, I. Vasserman, G. I. Erg, Yu. A. Evtushenko, N. G. Gavrilov, G.N. Kulipanov, A. S. Medvedko, S. P. Petrov, N. A. Vinokurov, A. Friedman, S. Krinsky, G. Rakowsky, O. Singh, "The Elliptical Multipole Wiggler Project," Proc. 1995 Part. Accel. Conf., Dallas, Tx, May, 1995.
- [4] O. Singh, S. Krinsky, P.M. Ivanov, and E. A. Medvedko, "Orbit Compensation for the Time Varying Elliptically Polarized wiggler," Rev. Sci. Instrum. 67(9), September 1996.

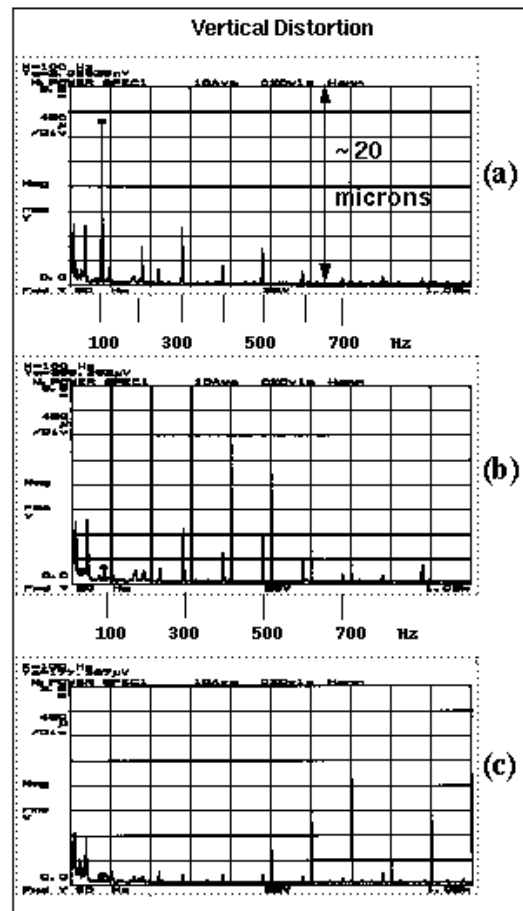

Figure 6: Fourier spectrum of vertical orbit when EPW switching at 100 Hz: (a) no compensation (b) 1st iteration compensation and (c) 1st and 2nd iteration compensations.

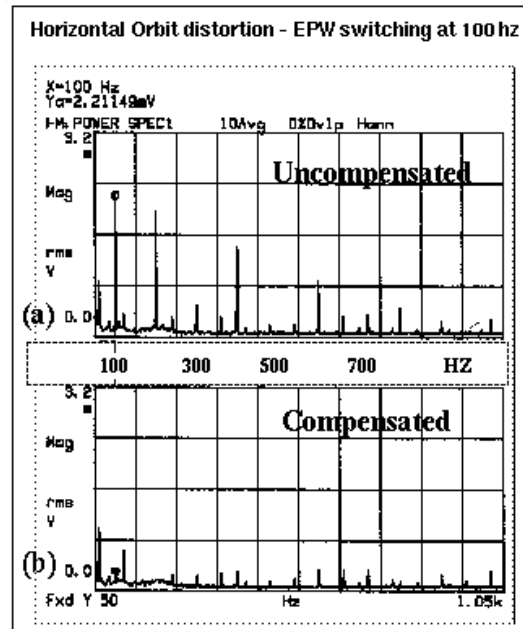

Figure 7: Fourier spectrum of horizontal orbit when EPW switching at 100 Hz: (a) no compensation and (b) with full compensation.