

# PERFORMANCE OF ELECTRON GUN FOR SPRING-8 LINAC

T. Asaka, T. Hori, Y. Ito, T. Kobayashi, A. Kuba, A. Mizuno, H. Sakaki,  
S. Suzuki, T. Taniuchi, K. Yanagida, H. Yoshikawa and H. Yokomizo  
Spring-8, Kamigori, Ako-gun, Hyogo, 678-12 Japan.

## Abstract

A thermionic gun of the injector linac for SPring-8 is required to generate different beam pulse width, 1nsec, 10-40nsec, 1μsec. Three types of grid pulsers were prepared to generate different beam pulse width. The gun uses cathode-grid assembly (EIMAC Y796) and operates up to 200kV anode voltage. In order to research characteristics of the electron gun, emission current from gun were measured by the wall current monitor. In this paper, the pulser system and characteristics of the emission current in region from 30mA to 19A are described.

## 1 INTRODUCTION

SPring-8 is one of the largest ultrahigh brilliance X-ray synchrotron radiation facilities under construction at harima science garden city in Hyogo prefecture. The facility consists of a 1GeV S-band injector linac, an 8GeV booster synchrotron ring and an 8GeV storage ring. The 1GeV linac is not only a injector linac of an 8GeV booster synchrotron but also injector linac of a 1GeV NEW SUBARU ring (VUV-soft X-ray ring, under construction) and to utilize for some experiments like to a slow positron facility and the parametric X-ray source[1]. The injector linac composes of a 250MeV high current linac, an electron / positron converter, a 900MeV main linac and a beam transport line. This linac is able to produce various kind of the beam pulse width from 1nsec to 1μsec, which are requested by the storage ring operation mode; multi bunch operation and a single bunch operation. In addition, the peak current from injector linac is defined by two modes; one is a high current mode (>15A) for positron production, and the other is relatively low current mode for electron use. The beam current is controlled with varying the emission current from a gun, and also by physically defining the beam size using an iris that is placed just behind the gun. The basic requirements for SPring-8 gun are summarized in table 1.

	Pulse width	Electron
Single bunch mode	1nsec	300mA
Short pulse mode	10-40nsec	300mA
Long pulse mode	1μsec	100mA

Table 1 Beam parameters of the gun

A beam commissioning of the injector linac has been started from August 1996 after sufficient rf processing, and the commissioning of the booster synchrotron has been

started from December 1996. In especially, a peak electron beam current of 50mA with beam pulse width of 40nsec is required from the first beam condition for the commissioning of booster synchrotron. However, the range of 50mA for the beam current is too low to control with varying a grid potential of Y796 owing to strain of the waveform of emission current that is observed by the wall current monitor[2]. In order to generate the low beam current with rectangular waveform, the gun was operated with controlling of both heater power and grid voltage. The optimum parameters of the gun system is obtained from the measurement results of emission current dependence on anode voltage, heater power and grid voltage under consideration for shaping waveform of emission current.

## 2 GUN DESIGN AND PULSER SYSTEM

The thermionic gun is the EIMAC Y796 cathode grid assembly, which has a circular cathode area of  $2\text{cm}^2$  equivalent to 8mm in radius. The gun is pulsed at 60Hz with a rectangular waveform variable from 1nsec to 1μsec in pulse width.

E-GUN was used to design the thermionic gun focus, anode electrode shape and the gap between cathode and anode, and to simulate the beam parameters in the gun region. The optimum of gun geometry was determined by obtained minimum emittance at the gun exit (150mm from cathode plane). The anode cathode gap distance is 30mm and the perveance is  $0.20\mu\text{perv}$ . A space charge limited flow at 200kV is 18.2A. The anode voltage of 200kV has been chosen as high as possible in order to reduce the space charge force at high current beam generation. The normalized emittance at the gun exit is  $15.3\pi\text{mm.mrad}$  and the beam radius is 8.1mm.

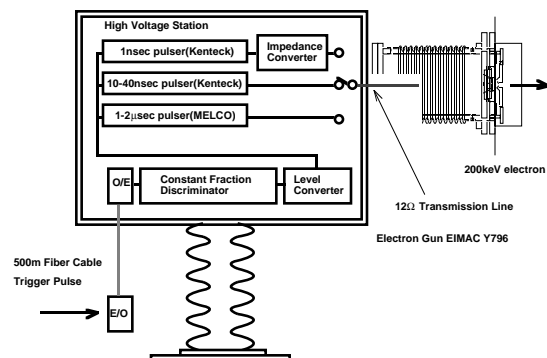

Fig.1 Schematic of the gun system

A schematic drawing of the gun system is shown in Fig.1. Three types of grid pulsers are prepared to generate different beam pulse width. A long pulse of more than

1 $\mu$ sec is generated by a constant voltage pulse generator (MELCO), and a short pulse of 10-40nsec is generated by nano second pulser (Kentech Instruments Ltd.), and a single pulse of 1nsec is generated by a high voltage modular pulse source (Kentech Instruments Ltd.). These pulsers are installed in a high voltage station, and are connected by two types of the transmission lines which are made of 1068mm long axial rigid tubes with 12 $\Omega$  impedance. One is used for generating short pulse and long pulse, and other is used for generating single bunch, it is composed of impedance converter and short stab[3].

Since the timing jitter of trigger signal of less than 30psec (FWHM) is required to inject the 2nsec rf bucket of the 508.58MHz booster synchrotron and the 508.58MHz storage ring in single bunch beam operation, the gun trigger system and transfer line used the passive circuit, the fast rf amplifier, the optical fiber cable and the E/O, O/E transmitter and receiver which have low jitter and low temperature dependence[4].

### 3 EMISSION CURRENT MEASUREMENT

The first beam tests selected short pulse mode using the nano second pulser. The beam pulse width is determined by the delay cable length between ON trigger output and OFF trigger input at this pulser. In order to make impedance matching at the driving cathode impedance (12 $\Omega$ ), the output channel of pulser are prepared four connectors (BNC type, 50 $\Omega$  for one channel). Fig.2 shows the observed the waveform of pulser output for 10nsec mode and 40nsec mode, respectively.

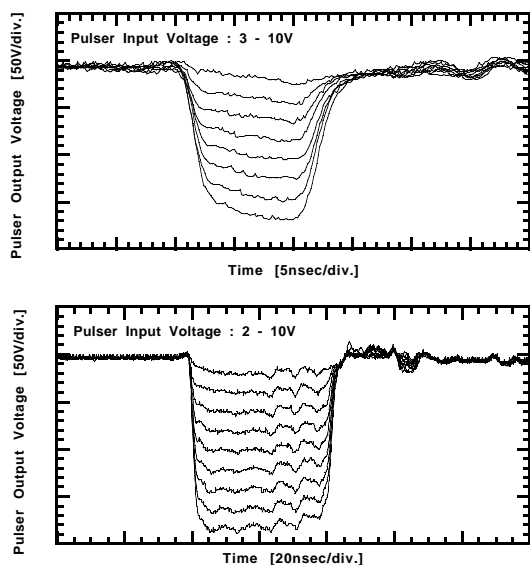

Fig.2 The waveform of nano second pulser output

The emission current from the gun was observed by the wall current monitor which was calibrated by means of a tapered coaxial test stand. The monitor is placed at the beam pipe prolongs for about 45cm after the cathode. The helmholtz coil is positioned right next to the gun. An adjustment of the beam size was performed by using the helmholtz coil and the fluorescent screen monitor.

The waveform of the emission current at 10nsec pulse

width is shown in Fig.3. The gun parameters are follows: iris none, heater voltage of 6.7V (heater power of 40W), anode voltage of 180kV and grid net drive voltage of 110V. And the pressure level of the gun is kept in the range of 10<sup>-8</sup>Torr. For the results of the first gun test without using the iris, the behavior of emission current as a function of the grid pulser voltage for different values of the heater power, the anode voltage and the bias voltage are shown in Fig.4, 5, 6. The perveance from Fig.5 is 0.35 $\mu$ perv which is higher than design value.

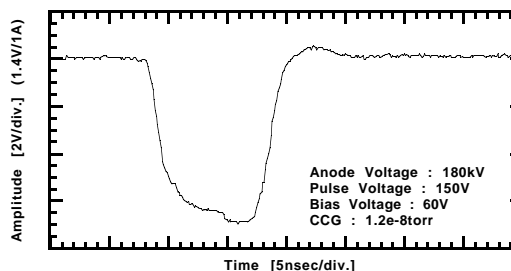

Fig.3 The emission current at 10nsec pulse width

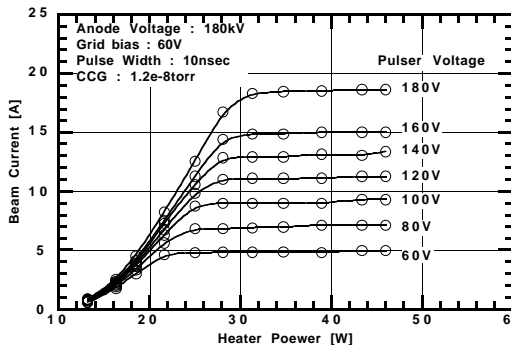

Fig.4 Emission current characteristics versus heater power

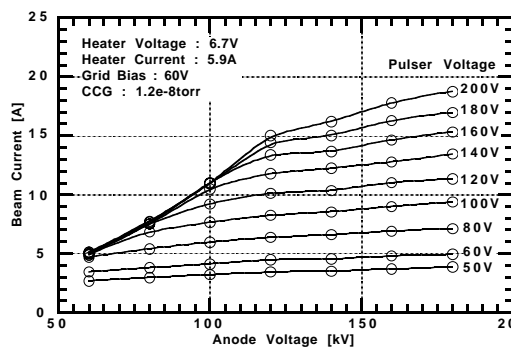

Fig.5 Emission current characteristics versus anode voltage

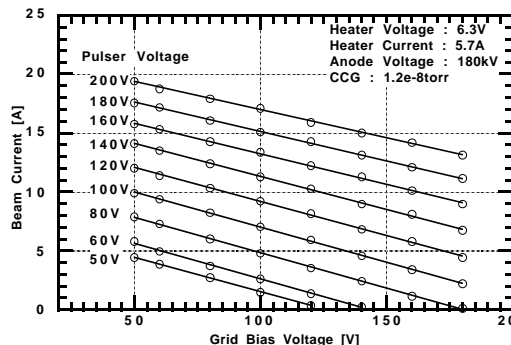

Fig.6 Emission current characteristics versus grid voltage

The emission current from the gun is reduced with the two types of iris. The reduction ratio are measured 7% of  $\phi 1.2\text{mm}$  iris and 26% of  $\phi 2.6\text{mm}$  one, respectively. These values were independent of the operating heater voltage in region from 3.5 to 6.5V.

In order to investigate the relations of the emission current and the waveform, the beam pulse width and the flatness of pulse height for different values of the emission current is measured by the wall current monitor. The gun parameters are follows: operation mode of 40nsec beam, iris of  $\phi 1.2\text{mm}$  and anode voltage of 180kV. Fig.7 shows the example of pulse width (FWHM) which depends on the grid bias voltage with the heater voltage of 4.0V (heater power 15W). In this figure, it is shown that the beam pulse width reduce with increasing grid bias voltage with regard to the pulser voltage below 90V. Fig.8 shows the flatness of waveform as a function of the heater power for different values of the emission current on condition that the pulse width (FWHM) is region from 35 to 43nsec. In case of the commissioning of the booster synchrotron, the optimum value (flatness <3%, peak current 50mA) is determined 3.6V in heater voltage from the results of Fig.8. In addition, Fig.9 shows the heater voltage versus flatness for different value of pulse and bias voltage under the above condition. The deterioration of flatness with net voltage below -50V depends on the flatness of pulser output in Fig.2 The state of flat-top for the pulser output is independent of the different pulse height.

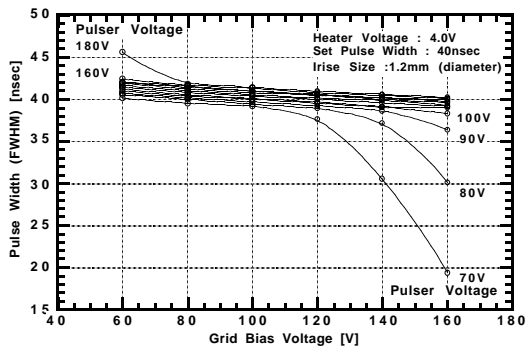

Fig.7 Pulse width characteristics versus grid voltage

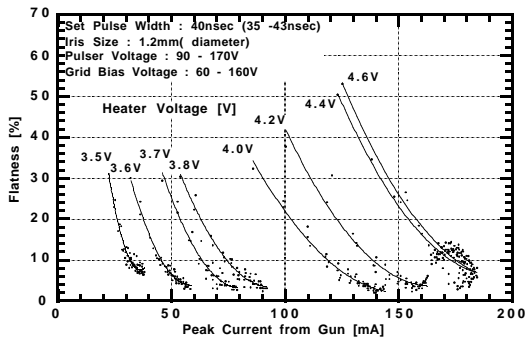

Fig.8: Dependence on the pulse flatness

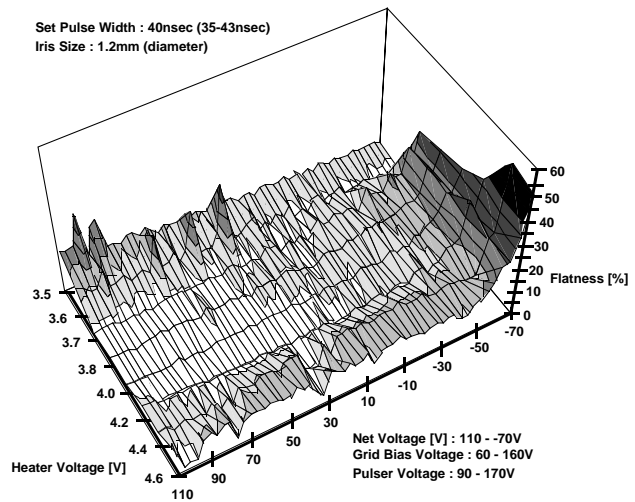

Fig.9: The heater voltage versus flatness for different value of pulser and bias voltage

## 4 CONCLUSION

We have generated the emission current in region from 30mA to 19A with the fast rise and fall time using nano second pulser. In order to produce rectangular waveform at the low current beam generation (flatness <3%, peak current 50mA), it is performed by control both of an iris and the heater power, simultaneously. In especially, the deteriorating flatness with the low bias and pulser voltage is caused by waveform of the nano second pulser output. Further experiments will be continue to examine the stability for the long term of operation on the gun.

## 5 ACKNOWLEDGEMENTS

We also thank to H. Akimoto, T. Onishi, S. Nagasawa, M. Yamazaki, K. Harumoto, T. Hasegawa, N. Hirota, T. Iida, K. Makino, K. Nakashima, S. Nakajima, H. Ohkubo, S. Suwa, A. Tuboi, T. Watanabe and M. Yoshioka of SPring-8 service corporation for the beam operation, the data taking, cooperation and support.

## 6 REFERENCES

- [1] S. Suzuki, et al., "Update Plan of Spring-8 Linac", Proc. of the 18th International Linac Conference (Geneva), Aug. 1996
- [2] K. Yanagida, "Wall Current Monitor for SPring-8 Linac", JAERI-M 94-078.
- [3] H. Yoshikawa, et al., "High Current 1ns Pulse Electron Gun", Proc. of the 17th International Linac Conference (Tsukuba), Aug. 1994
- [4] H. Suzuki, et al., "Characteristics of RF Reference and Timing Signal Distribution for SPring-8", Proc. of the 9th Symposium on Accelerator Science and Technology (Tsukuba), 1993