

PROGRESS TOWARD A MILLI-AMPERE NUCLEAR POLARIZED H⁻ SOURCE*

A. Hershcovitch, J.G. Alessi, B. DeVito, A. Kponou, T. Niinikoski[†]
 AGS Department, Brookhaven National Laboratory
 Associated Universities, Inc., Upton, New York 11973 USA

Abstract

A new polarized H⁻ source producing currents at the milli-Ampere level was designed and is presently being assembled at BNL. This source is composed of three novel elements which have been developed separately. A cold atomic beam yielded H⁰ fluxes as high as 9.4×10^{18} and 4×10^{19} atoms/s-sr at accommodator temperatures of 5.8 K and 26 K respectively. A superconducting solenoid for spin selection designed to have an acceptance angle of 0.1 sr for this atomic beam was developed. A ring magnetron ionizer, which converts H⁰ to H⁻ by charge exchange with 200 eV D⁻, yielded 500 μA of H⁻ for an estimated H⁰ density of 10^{12} cm⁻³. A successful matching and assembling of these elements should result in a milli-Ampere polarized H⁻ source.

Introduction

Sources of polarized ground-state atomic hydrogen beams are based on magnetic separation. The advantage of cooling hydrogen atoms before their exposure to a magnetic field gradient for spin selection has been recognized for quite some time.¹ Denoting by B_m the pole-tip field of a six-pole magnet, the solid angle of acceptance ΔΩ (averaged over the thermal velocity spectrum) is¹

$$\langle \Delta\Omega \rangle = 2.09 \frac{\mu_B B_m}{kT} = 1.4 \left(\frac{B_m}{\text{Tesla}} \right) \left(\frac{T_b}{\text{K}} \right)^{-1} \quad (1)$$

where μ_B is the Bohr magneton and T_b the beam temperature. All past attempts of cooling H⁰ beams have failed so far to demonstrate a corresponding increase in the spin-selected beam intensity. The main reasons for it have been loss of H⁰ flux during the cooling process and improper matching of other elements in a source. A comprehensive explanation of the latter is offered by using the acceptance diagram method of Zhang, Schmelzbach, Singy, and Gruebler² which properly accounts for the matching of all beam elements, including the ionizer volume.

The use of an acceptance diagram to match the beam geometry also underlines the importance of a narrow velocity distribution. For this, the significance of a good vacuum after the beam-forming nozzle or orifice has been demonstrated in many operating sources. In addition to cooling the H⁰ beam, the acceptance angle of the spin selecting magnet can be further increased by increasing its pole tip field as Equation 1 indicates. As <ΔΩ> increases, the density of polarized H⁰ atoms at the magnet focal point rises; however, their emittance grows as well. This dictates the need for an ionizer which is much shorter and more efficient than those presently in use. The ring magnetron meets these criteria.

Development of this polarized H⁻ source has been proceeding on three fronts: (1) development of a

cold high-intensity atomic hydrogen beam, (2) development of a high magnetic field superconducting solenoid for spin selection, and (3) development of a short, efficient ionizer.

Cold Hydrogen Beam

In our experimental apparatus (Fig. 1), atomic hydrogen is produced by a conventional dissociator; the atomic flow is then guided by a transition section (made either of teflon or of glass) into a copper accommodator cooled by a cryostat to liquid helium temperatures. Cooling of the flowing gas is achieved by radial heat conduction to the cold accommodator surface. Superficially this apparatus is very similar to other devices^{3,4} in which low intensity beams have been successfully cooled to the 5-8 K range. Walraven and Silver's source³ achieved an 8 K beam with 2.4×10^{16} atoms/sec. Crampton⁴ obtained 4.5×10^{13} polarized atoms/sec at an accommodator temperature of 5.35 K. In these sources the flow is in the molecular regime. Our objective is to cool to that temperature range a beam of more than 10^{19} atom/sec which is achievable only at densities in the continuum flow regime.

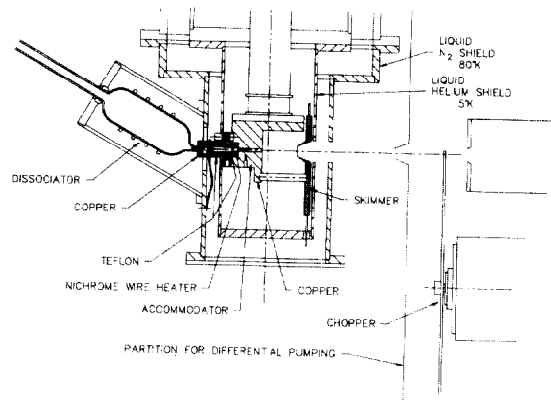

Fig. 1. Schematic of the interior of the cold hydrogen beam test box. The skimmer plate is coated with activated charcoal and cooled to ~2.5 K to act as a very efficient cryopump.

The atoms are cooled by wall collisions in the channel through which they pass. This poses a problem because hydrogen very readily recombines on materials in the 100 to 30 K temperature range. To overcome this problem, the teflon and copper channels are separated by a 0.3 mm gap and they are maintained at 130 K and 6 K respectively. At 130 K, recombination of hydrogen on teflon or glass is negligible. Below 20 K, molecular hydrogen freezes on the copper, and recombination of atomic hydrogen on it is also negligible. The flow regime of the beam in the channels dictated a very short gap in order not to lose beam collimation.

*Work performed under the auspices of the U.S. Department of Energy.

[†]On leave from CERN, Geneva, Switzerland.

Using a quadrupole mass analyzer and a chopper (for time-of-flight technique) we investigated variation of beam density and velocity with accommodator temperature and diameter as well as dissociator orifice diameter. Some of the implications of these results regarding beam optics were verified in beam focussing study with a conventional sextupole.⁵

The density increased as the orifice size was increased for 0.8 mm² to 7 mm², although by a smaller factor. The variation of beam density with accommodator temperature is shown in Fig. 2, and velocity distribution measurements at the peaks are shown in Fig. 3. These results have been discussed in detail elsewhere, together with an attempt to give them a gas dynamical interpretation.⁵ The much narrower distribution observed at 5.8 K means that the beam optics should be better at this temperature. Fluxes of 9.4×10^{18} and 4×10^{19} atoms/s/sr were obtained at accommodator temperatures of 5.8 K and 26 K respectively.

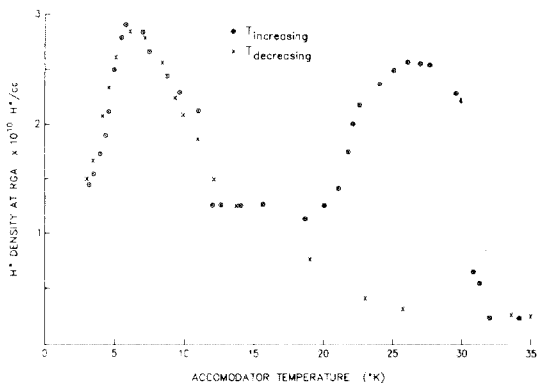
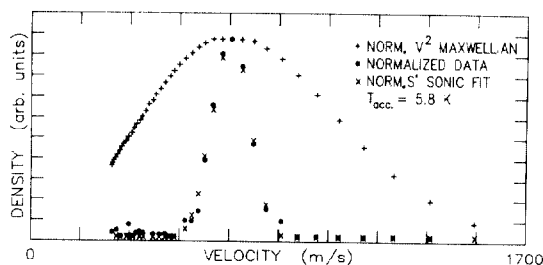
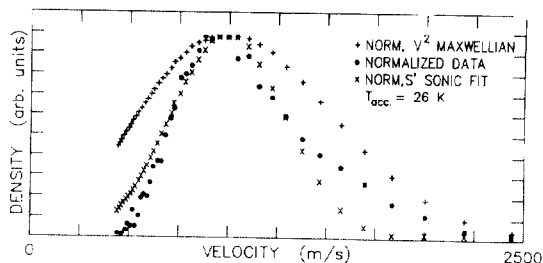

Fig. 2. Variation of hydrogen beam density with accommodator temperature.



(a)



(b)

Fig. 3. Results of velocity distribution measurement with $T_{acc} \sim$ (a) 6 K and (b) 26 K.

To further improve the vacuum as well as to allow for prolonged periods of operation at a repetition rate of 10 Hz (instead of the 0.5 Hz used during the above studies), a new dissociator was developed. This dissociator has a volume which is a factor of 11 smaller. The usual bulb is replaced by a straight tube, and the helical rf coil is replaced by a spiral one. Bench tests indicate comparable H^o output at 60% reduced gas load and 66% lower rf power consumption for this more compact system at 10 Hz; and, an order of magnitude reduction in gas consumption at 0.5 Hz operation.

Superconducting Solenoid

The acceptance solid angle of a sextupole magnet is $\Omega \sim 2 \mu B_0/kT$ for a source at the magnet's entrance and a beam having a Maxwellian velocity distribution. For $B_0 \leq 1$ T and a most probable velocity of 680 m/s (when the accommodator temperature is 5.5 K), the calculated solid angle is $\Delta\Omega \leq 0.05$ sr. It is smaller still because, for practical reasons, the source is usually several centimeters away from the magnet entrance. It was decided to test a superconducting solenoid as the lens element since it can produce suitable field gradients over a large aperture.⁶ The solenoid consists of three coils which are connected in series, with the current in the outer two counter to the current in the middle coil. The overall length of the solenoid is 10 cm and it has a useful i.d. of 9.4 cm. Field maps for the solenoid were generated with the program POISSON. A second program tracked H^o atoms through the calculated fields. The result of a track-tracing calculation is shown in Fig. 4. The box on the right represents the ionizer. We estimate the acceptance angle to be 0.1 sr.

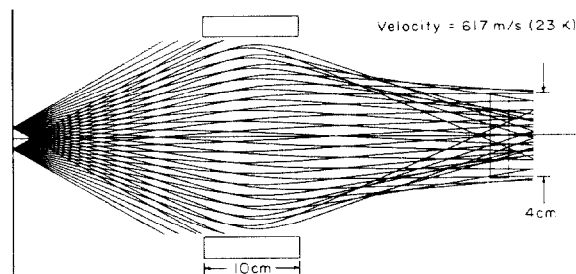

Fig. 4. Output of the track-tracing calculation for $B_0 \sim 5$ T at a radius of 5 cm in the mid-plane of the solenoid. A 2 cm dia. aperture at the ionizer (box on the right), intercepts about 50% of the focussed beam.

Mounting the source very close to the solenoid was considered since pumping should not be a problem with the abundance of cryopanel between the accommodator and solenoid, but track-tracing showed that the beam could not be brought to a tight enough focus at the ionizer.

The calculated field of the solenoid at $r = 4.7$ cm in the median plane is 4.5 T for a current of 110 A. A calculation with POISSON using the actual ampere-turns, and a subsequent track-tracing calculation showed that the effect on the optics was negligible.

We estimate that, with the atomic beam characteristics measured on the test stand, we can obtain a

flux of $\sim 3 \times 10^{17}$ atoms/s with a 1 cm radius at the ionizer, and an average density of 1.3×10^{12} atoms/cm³. It should be noted that chromatic aberrations are considerable with this solenoid and that we expect further magnet improvements to yield higher densities.

The New Source

Based on the results of these studies, a prototype source which incorporates all the newly developed elements has been designed. The accommodator of this source is shaped (based on theory⁵) to prevent volume recombinations during beam cooldown to the 6 K level. If this aspect of the theoretical prediction proves correct, the H⁰ flux at the 6 K level may increase by a significant factor. Since there has been excellent agreement between theory and experiments on other matters,⁵ there are reasons to believe that the density of polarized H⁰ calculated in the previous section is a lower limit. The basis of the new source is shown in Fig. 5.

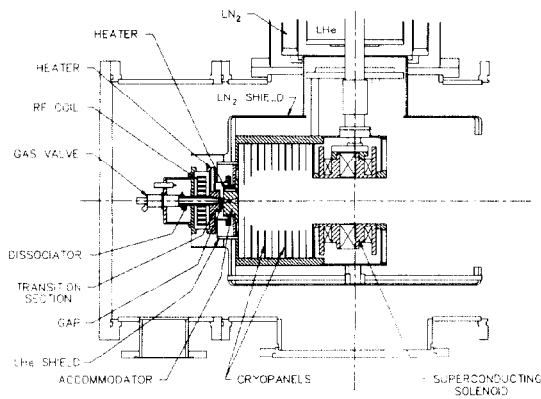
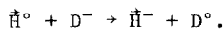

Fig. 5. Schematic of the polarized hydrogen beam part of the new source mounted to the LHe cryostat. It incorporates a new dissociator, an improved accommodator, and a superconducting solenoid.

The solenoid was mounted on the foot of the LHe cryostat as shown in Fig. 5. Prior to assembly in the source, the solenoid was tested and reached a peak current of 119 A (4.76 T) before quenching; and, it was able to hold 110 A (+ 4.4 T) for 20 minutes before quenching. Almost all of the components shown in Fig. 5 were fabricated and are now being assembled and tested. Next, an rf transition section will be installed inside the LN₂ shield on the downstream side of the magnet, following which the ring magnetron will be added.

Ring Magnetron Ionizer

The ring magnetron ionizer⁷ was proposed as a way to surmount the problem of space charge blowup of the ionized beam inherent in the ionizing reaction:



This reaction has a cross section about five times greater than the cesium charge exchange reaction used in PONI-I. A schematic of the ionizer is shown in

Fig. 6. The molybdenum cathode is the cylinder with two grooves cut on its inside surface. The anode is a stainless steel cylinder with 0.05" wide slits, having a total length of 9 mm. D⁻ ions emerge through the slits as shown with ~200 eV energy from the cathode voltage and ionize the H⁰ beam passing through the magnetron. Up to 700 mA of self-extracted D⁻ has been measured on the axis. Enough D⁺ ions drift into the reaction volume to provide space charge neutralization. The magnetic field will also serve to preserve the polarization.

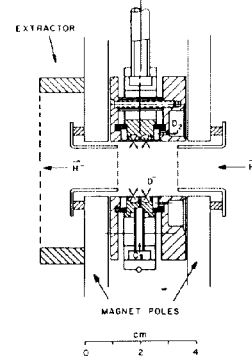

Fig. 6. Schematic of ring magnetron ionizer for the proposed AGS milliampere polarized H⁻ source.

To test the ionization, unpolarized H⁰ was injected through the magnetron as shown in Fig. 6. 500 μA of H⁻ coming from the resonant charge exchange was extracted at 2-3 kV. With an estimated H₀ density in the center of the ionizer of 10¹² atoms/cm³, the ionization efficiency is ~ 4 better than for the Cs ionizer in PONI-I.

The ring magnetron has now been combined with a polarized atomic beam stage, to see if there is any depolarization during ionization. We are presently working on optimizing the extraction optics of the new system to first get back to the ionization efficiency observed on the test stand. Following the polarization measurements, the ionizer will be combined with the cold atomic beam and superconducting solenoid.

References

1. W. Haeberli, *Ann. Rev. Nucl. Sci.* **17**, 373 (1967).
2. W.Z. Zhang, P.H. Schmelzbach, D. Singy, and W. Gruebler, *Nucl. Inst. Meth.* **A240**, 229 (1985).
3. J.T.M. Walraven and I.F. Silvera, *Rev. Sci. Instr.* **53**, 1167 (1982).
4. S.B. Crampton, K.M. Jones, G. Nunes, and S.P. Souza, *Proc. of the Precise Time and Time Interval Planning Meeting*, Goddard Space Flight Center, Nov. 27-29, 1984.
5. A Hershcovitch, A. Kponou, T.O. Niinikoski, to be published in April 1987 issue of RSI.
6. T.O. Niinikoski, S. Pentilla, J.M. Rieubland, A. Rijllart, *AIP Conf. Proc. No. 117*, Am. Inst. of Phys., New York, 139 (1984).
7. J.G. Alessi, *Helvetica Physica Acta* **59**, 547 (1986).