

Content from this work may be used under the terms of the CC BY 3.0 licence (© 2019). Any distribution of this work must maintain attribution to the author(s), title of the work, publisher, and DOI

# THE COMMISSION OF HOME-MADE 500MHZ, 80KW SOLID-STATE AMPLIFIER IN NSRRC

T. C. Yu†, Ch. Wang, L. H. Chang, M. S. Yeh, M. C. Lin, C. H. Lo, F. T. Chung, M. H. Chang, L. J. Chen, Z. K. Liu, Fu-Yu Chang, S.-W. Chang, Yi-Da Li, NSRRC, Hsinchu, Taiwan

## Abstract

Solid-state for high power RF application is an attracting and interesting technology which is now become popular in accelerator field. To adopt and master such technique, a 500MHz, 80kW solid-state amplifier is thus developed in NSRRC. The amplifier is consisted of 100 900W amplifier modules which are driving by identical modules. Each module contains input and output directional couplers and status monitoring circuits. To have longer life time and better performance, the RF power transistors are integrated with water cooled heat sink directly. In such a way, the transistors have higher output power and better efficiency. The RF power of each module is combined through coaxial combiner while its DC power is provided by parallel connected DC power supplies which can provide better redundancy and reliability. The home-made solid-state amplifier is demonstrated to have quite high quality RF power and reliability with acceptable power combination efficiency.

## INTRODUCTION

After the successful power delivery of 8.5kW by ten 900W solid-state power amplifier (SSPA) modules in 2016 [1] and 18kW by twenty 900W SSPA modules in 2017, 80kW continuous power is successful delivered in 2019 by one-hundred 900W SSPA modules power combination in NSRRC. The amplifier module, designed by NSRRC, includes planar balun push-pull power amplifier circuit [2], RF power transistor BLF578XR, 1000W circulator, 1200W stripline load and a status monitoring circuit. The circuit with cooling plate design without circulator is demonstrated to be able to operate at 1kW continuously for 1000 hours with lower than 1% power drop. In addition, the RF power combination efficiency is quite robust to the amplitude and phase variation among the SSPA modules [3]. By adding a circulator, 0.2-0.25 dB additional loss is thus applied after the RF power transistor output. For 1kW RF output at the transistor side, the circulator from Valvo with 1kW power capability can delivery about 944-954W as its limit. Therefore, the SSPA module was thus designed to deliver 900W as its saturation working point.

The 80kW SSPA is accomplished by 3 stage power amplification as shown in Figure 1. The 1<sup>st</sup> stage is consisted of two 100W pre-amplifiers which can deliver maximum 200W RF power in total via a 10-way power divider to ten 2<sup>nd</sup> stage drive amplifiers. The 2<sup>nd</sup> stage drive amplifiers are thus used to drive the final one-hundred amplifier modules via ten 10-way power dividers. The final stage 100 amplifier modules are divided as 10 groups and each group are first combined by home-made power combiner then combined again by a 10-way travelling wave coaxial power

combiner which is a custom design for NSRRC from COM-TECH. Such coaxial power combiner features equal power distribution with 90° phase difference between each ports according to its position. To gather the RF power properly at the final stage power combiner, proper phase-shifters are thus added before each 2<sup>nd</sup> stage drive amplifier. The output RF power shows quite efficient power combination without significant power loss at the final stage power combiner. The 500MHz 80kW SSPA is completely designed, manufacture, assembled and power test in RF lab of NSRRC and its picture is shown in Figure 2. The prototype of the SSPA adopts separate modulator power supply rack for easier system diagnosis, trouble shooting and redundancy. However, this way also brings the drawback of longer DC power wires with more heat loss and additional voltage drop.

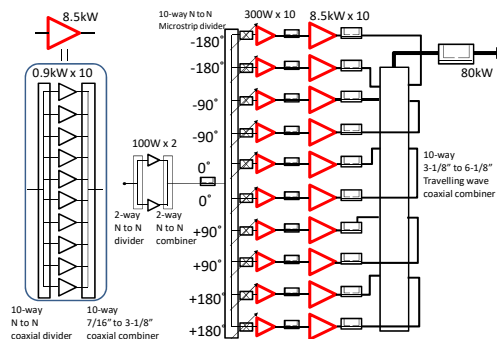

Figure 1: The 80kW Solid-state amplifier system schematic diagram.

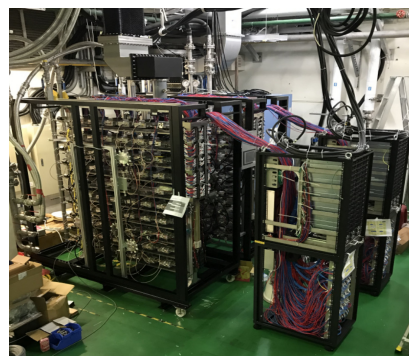

Figure 2: The 80kW solid-state amplifier with two separate power supply racks.

## THE FEATURES AND INTEGRATION OF THE SSPA SYSTEM

The 500MHz 80kW fully solid-state power amplifier system consisted of two 100W pre-amplifiers, ten 900W

† yu.tc@nsrrc.org.tw

drive amplifiers, one-hundred 900W output amplifiers, two 2-way isolated power divider/combiner, eleven 10-way 300W non-isolated power divider, ten 10-way 10kW non-isolated power combiner, one 10-way 80kW non-isolated final stage coaxial power combiner, two 96kW DC power supply rack and a PLC controller with its MMI interface. The solid-state amplifier modules features planar balun push-pull amplifier circuit and its RF power transistor, circulator, stripline power load and status monitoring circuits are contact directly to water cooling plate, as show in Figure 2. The thermal grease between the RF power transistor and copper cooling plate adopts liquid metal thermal grease to enhance its thermal conductivity from 11.6 W/m-K to 128 W/m-K with excellent electrical conductivity. Such way can obvious reduce the junction temperature of the RF power transistor down to below 100 °C at saturation power to have better performance and durability. The water cooling plate has 4 channels for better cooling rate and proper thermal averaging while in series connection. Six (6) cooling plates of the amplifier modules are series connected by 1/2" water pipe for lower total water flow volume requirement. The amplifier modules are positioned on two separate racks and each rack contains 60 slots as two (2) 6x10 matrix. There are 20 water flow pipes in total with 10 lit/min flow rate for each row on the amplifier rack. The RF outputs of the final stage SSPA modules face the centre of two amplifier racks and are connected to ten 1<sup>st</sup> stage power combiners as ten 8.5kW RF output ports. These ten 3-1/8" coaxial outputs are connected to final 10-way coaxial combiner according to phase arrangement. The final RF output are transferred from 6-1/8" coaxial to WR1800 waveguide and connected to a 350 kW ferrite load through a 350 kW circulator for high power test.

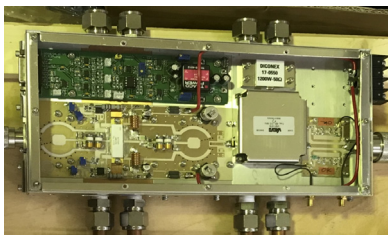

Figure 2: The 900W SSPA module integrated RF power circuit, circulator, PCB directional coupler, stripline load, status monitor circuit and water cooling plate.

Each RF rack is connected to a power supply rack which can delivery maximum of 96kW DC power. The DC power supply can adjust its output DC voltage from 42V to 56V by their controller for changing the working point of amplifier circuit. Each amplifier is supplied by four 3.5mm<sup>2</sup> wires and two 20A fuse for proper DC current capability and short circuit protection. There are also additional terminals between power supply and the SSPA modules for easier trouble shooting and system diagnosis. The 3D view of the SSPA system layout is shown in Figure 3.

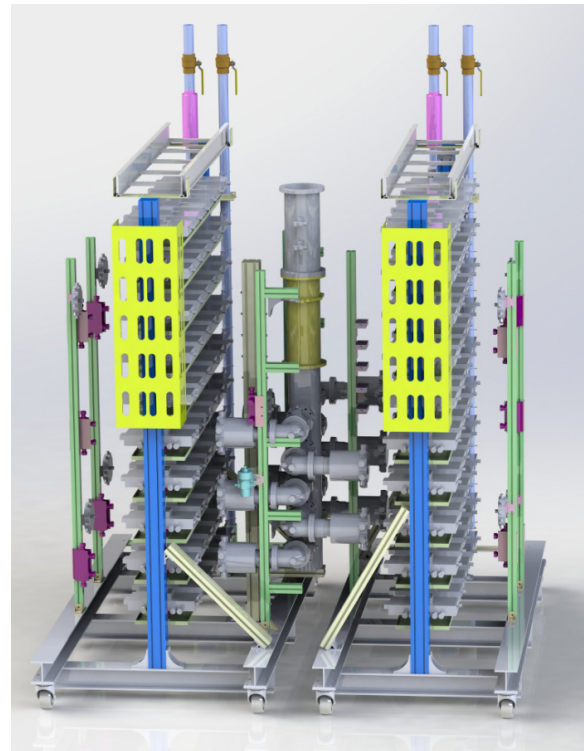

Figure 3: The 3D view of NSRRC home-made 500MHz, 80kW SSPA system.

## TROUBLE SHOOTING PROCEDURE DURING POWER COMMISSION

Since the amplifier modules are integrated directly with water cooling plates, the water leak needs to be check carefully when apply water pressure for first time. Although the water leak check for each amplifier modules was done up to 10 kgf/cm<sup>2</sup> when the Swagelok type connector are first connected, some small leak was still found on the rack and can be stop by simply tightening the screw of the water connectors. The total required water flow volume for total amplifier racks is about 200 L/min with about 2.5 kgf/cm<sup>2</sup> pressure drops between inlet and outlet pipes. When all SSPA modules are all installed with water pipe on their position, the RF input and output cables are connected for each input and output ports. Due to compact space between the SSPA racks, the 1/2" RF output cables at one rack are connected to power combiner first then the RF output cable at another rack would be connected later. The DC power wiring for each SSPA modules was also checked manually one-by-one from fuse to module to make sure the terminal mappings are all correct.

The first high power test was successful at VDC=48V and 70kW was reached and confirmed by calorimetric method of cooling water flow and temperature. After that, the 80kW RF power can also be reached by adjusting the VDC to 50V. During long-term commission, two RF cables and five SSPA modules are found to be damaged. The RF cables fault was found to have melt skin at outside with arc or colour changing of the inside metals as shown in Figure 4. The skin-melted positions are found to be near the con-



Content from this work may be used under the terms of the CC BY 3.0 licence (© 2019). Any distribution of this work must maintain attribution to the author(s), title of the work, publisher, and DOI

connector and the non-proper contact of inner or outer conductor between connector and cable could lead to such failure. The possible reason of the failure of the SSPA modules could result from the non-proper pasting the thermal grease under the circulator. The four faulty SSPA modules are found to have too much thermal grease under them and this could lead to much higher temperature and poorer electrical contact during high power operation. The higher temperature could change the characteristics of the circulator and result in much higher standing wave ratio between RF transistor and the circulator. The flange of the transistor could be melted and arc finally as shown in Figure 5.

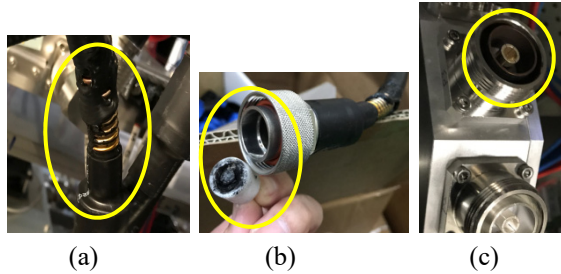

Figure 4: (a) The melt skin of fault RF cable (b) The carbonized inner conductor (c) The changed colour at outer conductor.

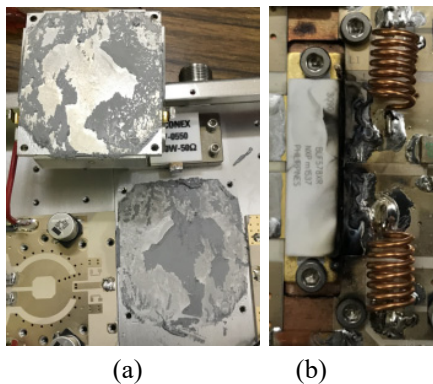

Figure 5: (a) The over pasting the thermal grease under the circulator and (b) Melt and arc flange of the RF transistor of faulty SSPA modules.

Another possible reason that could lead to the SSPA modules fault could result from the power unbalance. The unbalance could result from the unbalance of 1<sup>st</sup> power divider to 2<sup>nd</sup> drive amplifiers. Before adjusting balance condition, the maximum power difference could up to 1.47dB, then, the power difference could be down to 0.63dB after using isolated power divider as 1<sup>st</sup> power divider as shown in Figure 6. Larger power difference could lead to early faulty of SSPA modules as some are driven to deliver too much power out of their specification.

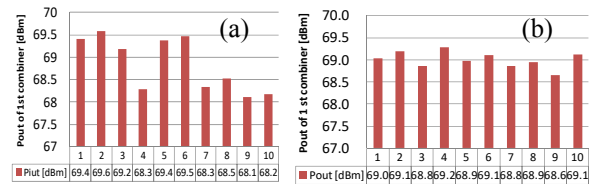

Figure 6: The power distribution of 1<sup>st</sup> power combiner groups (a) before and (b) after balance adjustment by using 12-way isolated power divider.

## COMMISSION RESULTS

The saturation output RF power can be adjusted by changing the DC voltage of the DC power supply and its efficiency will be changed accordingly as shown in Figure 7. The maximum output power is 80kW while the power limit for each of the ten groups is set to be 9 kW, the optimum AC-to-RF efficiency is about 49.5% at 52V DC. The RF output power and efficiency could also drop by 1.6 kW and 0.56% per unit by turn off 7 modules in sequence to let power drop from 81kW to 70kW as shown in Figure 8. The efficiency still has space to be improved. Long-term 80kW reliability test is also implemented up to 360 hours continuous run at output load of 1.1 VSWR without any trip or significant power drop.

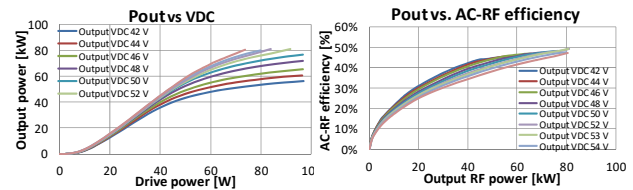

Figure 7: the output RF power and AC-RF efficiency vs. drive power by changing VDC

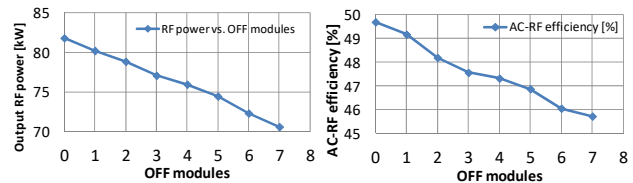

Figure 8: One OFF SSPA module could lead to about 1.6kW voltage and 0.56% efficiency drop.

## CONCLUSION

The 500MHz 80kW SSPA system is successfully design, construct, integration and commission in NSRRC. The highest output power could be limited as the power of any group of 3-1/8" ten-way combiner reaches its high limit of 9kW. Power balance could be the limit of total output power in the configuration of NSRRC design. However, the specified 80kW total output power can still be reached by reducing the power difference between ten output groups. The optimum AC-RF efficiency is about 49.5% as the average DC-RF efficiency of 100 modules at average output power 800W is about 59%. The AC-to-RF efficiency shall be further improved in the future.

This is a preprint — the final version is published with IOP

## REFERENCE

- [1] T. C. Yu, Ch. Wang, L. H. Chang, M. S. Yeh, M. C. Lin, C.H. Lo, M.H. Tsai, F.T. Chung, M.H.Chang, L.J. Chen, Z.K Liu, C.L. Tsai, Fu-Yu Chang “Development of a 500 MHz Solid-state RF Amplifier as a Combination of Ten Modules”, in *Proc. 7th Int. Particle Accelerator Conf. (IPAC'16)*, Busan, Korea, May 2016, pp. 563-566. doi:10.18429/JACoW-IPAC2016-MOPMY031
- [2] T.C. Yu, Ch. Wang, L.H. Chang, M.S. Yeh, M.C. Lin, T.T. Yang, C.H. Lo, M.H. Tsai, F.T. Chung, Y.H. Lin, M.N. Chang, L.J. Chen, Z.K. Liu, “Heat Distribution Analysis of Planar Baluns for 1kW Solid-state Amplifiers and Power Combining for 1.8kW”, in *Proc. IPAC'14*, Dresden, Germany, Jun. 2014, pp. 2294-2296. doi:10.18429/JACoW-IPAC2014-WEPME019
- [3] T. C. Yu, Ch. Wang, L. H. Chang, M. S. Yeh, M. C. Lin, C. H. Lo, M. H. Tsai, F. T. Chung, M. H. Chang, L. J. Chen, Z. K. Liu, C. L. Tsai, Fu-Yu Chang, “Quarter Wavelength Combiner for an 8.5kW Solid-State Amplifier and Conceptual Study of Hybrid Combiners”, in *Proc. 8th Int. Particle Accelerator Conf. (IPAC'17)*, Copenhagen, Denmark, May 2017, pp. 4324-4327. doi:10.18429/JACoW-IPAC2017-THPIK101