

Content from this work may be used under the terms of the CC BY 3.0 licence (© 2018). Any distribution of this work must maintain attribution to the author(s), title of the work, publisher, and DOI.

TRANSVERSE AND LONGITUDINAL BUNCH-BY-BUNCH FEEDBACK FOR STORAGE RINGS

T. Nakamura*, JASRI/SPring-8, Hyogo, Japan

Abstract

Transverse and longitudinal digital feedback systems are useful tools for most storage ring for suppression of beam instabilities and for fast damping of oscillations excited at beam injection. In this report, we summarize the concept of feedback systems and its recent advances, focusing on bunch-by-bunch feedback systems for electron beams with hundreds MHz bunch rate.

INTRODUCTION

Transverse feedback for horizontal or vertical betatron oscillations, and longitudinal feedback for synchrotron oscillation, for beams in storage rings [1-3] are widely used as powerful tools for suppression of beam instabilities, for fast damping of beam oscillations driven by perturbations like injection, and for the diagnostics and handling of the beam bunch-by-bunch base.

DIGITAL FEEDBACK SYSTEM

The concept of a digital feedback system is shown in Fig. 1. Bunches of hundreds MHz rate are circulating in a storage ring. Horizontal or vertical position or longitudinal timing position, of each bunch is measured by a beam position monitor (BPM) by turn-by-turn base. The signal from the BPM is converted by a front-end circuit to a position signal for a feedback processor. The processor is composed of an ADC, a DAC and, an FPGA: a digital processing unit between them. The ADC digitizes the position signal and send the digitized data to the FPGA. The FPGA calculates the required kick for feedback with an FIR filter and the result is converted to an analog signal by the DAC to drive a kicker. Angle kickers and energy kickers for transverse and for longitudinal, respectively, are mostly used.

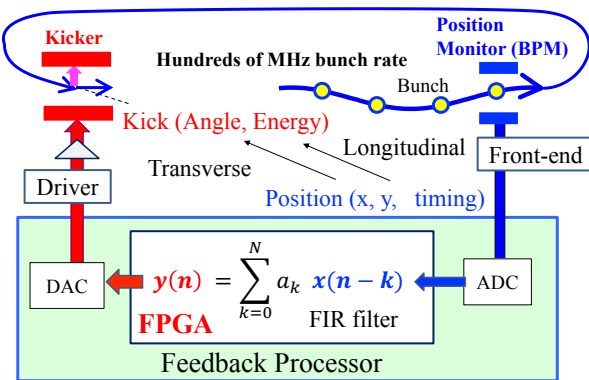

Figure 1: Concept of digital feedback.

* nakamura@spring8.or.jp,
 http://acc-web.spring8.or.jp/~nakamura

BEAM POSITION MONITOR AND FRONT-END

A BPM for transverse or longitudinal feedback is composed of several electrodes surrounding a beam as BPMs for slow orbit motion. The output signal of i -th electrode should have the form of

$$V_i = (1 + k_i(x + x_{cod}))(V_0(t) + \Delta V_i(t))$$

with $|k_i x| \ll 1$ and $|\Delta V_i(t)| \ll |V_0(t)|$ where x and x_{cod} are the transverse position shift to the electrode by the oscillation and by closed orbit distortion, respectively, k_i is a constant, and $\Delta V_i(t)$ is the difference of the signal shapes of electrodes by shape error, or mismatch at a feedthrough or at cable connections. To get the position signal, the difference of the signals of the electrodes with $k_j \sim -k_i$:

$$V_{ij} = V_i - V_j \approx 2k_i x V_0(t) + \Delta V_i(t) - \Delta V_j(t)$$

is produced with a 180-degree hybrid: the subtraction circuit of RF signals, with the adjustment of timing and level of V_i and V_j with variable delay and attenuator. For skewed position electrodes, the same sort of the difference signal is obtained with a matrix of 180-deg. hybrids.

In usual cases, the signal level of $\Delta V_{ij}(t) = \Delta V_i(t) - \Delta V_j(t)$ is much larger than that of $2k_i x V_0(t)$ and is corresponding to the beam position shift of several hundred micrometers. The shape of $V_0(t)$ is the derivative of the longitudinal charge distribution of a bunch, therefore is bipolar, and $2k_i x V_0(t)$ is also bipolar and the peak voltage of the signal is proportional to the position.

The signal level of V_{ij} is much smaller than those of V_i and V_j , therefore, can be amplified with high gain to a signal, $G V_{ij}$, with useful signal level. In SPring-8 case, the peak voltage of the bipolar signal $G V_{ij}$ is directly sampled with a wide analog bandwidth ADC [4], which eliminates widely used down-conversion stage (Fig. 2). The signal V_{ij} is bipolar therefore its signal level is higher at higher frequency. However, with direct sampling, the frequency band of $G V_{ij}$ is limited to 250M-750MHz, which is several times lower than that of the front-end with down-conversion and we may lose the signal level. On the other hand, the lower frequency band has wider acceptance of bunch timing shift that is discussed about later.

For longitudinal feedback systems, the timing signal is usually extracted from the sum signal of electrodes, $V_0(t)$, and its frequency band 1.5-2 GHz where the signal level and sensitivity of the timing is higher than lower frequency, are down-converted to the timing information signal.

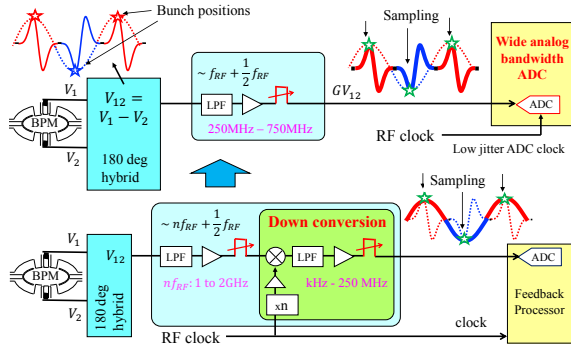

Figure 2: Front-end with RF direct sampling (top) and down-conversion to baseband (bottom).

FEEDBACK PROCESSOR

In early days of digital bunch-by-bunch feedback systems, a farm of DSPs [5,6] or a custom LSI [7] were used for the signal processing unit, and now FPGAs (Field Programmable Gate Array) are widely used for it [8-12] because an FPGA is a logic hardware; faster processing speed than CPU or DSP, however, its logic is programmable by users. ADCs with the sampling rate 500MHz, the 12-bit resolution, and the analog bandwidth more than 750MHz are easily available in the market. For the resolution of the ADC, the vertical beam size of in low emittance storage rings is tens of micro meters, therefore, we need the step size of micro meters resolution. However, because the signal level of the residual offset signal, $\Delta V_{ij}(t)$, is several hundred micro meters and, if we need the acceptance of order of 1mm by the external excitation like injection, 12-bit resolution should be necessary.

FIR FILTERS

Most of the feedback systems use an FIR filter for digital signal processing and it has simple structure as

$$y_n = \sum_{k=0}^N a_k x_{n-k} \quad (1)$$

For the feedback, x_{n-k} is the beam position at (n-k)-th turn, y_n is a required feedback kick at n-th turn, and a_k are coefficients and constant. As in Fig. 3, the FIR filter adds the gain and phase shift to the position signal to produce the feedback kick and eliminates the DC offset.

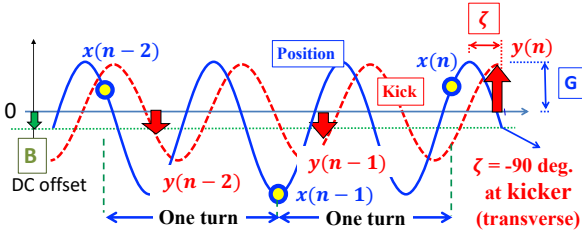

Figure 3: Position history and feedback kick.

The position data x_n and the kick y_n are both sinusoidal and can be expressed in complex form as

$$x_k = \tilde{x} e^{i2\pi k v} \quad (2)$$

$$y_k = G(v) e^{i\zeta(v)} x_k = G(v) \tilde{x} e^{i(2\pi k v + \zeta(v))} \quad (3)$$

where $G(v)$ and $\zeta(v)$ are the gain and phase shift added to the position data for tune v . Using those expressions, the tune response of the FIR filter is

$$G(v) e^{i\zeta(v)} = \sum_{k=0}^N a_k e^{-i2\pi k v} = \sum_{k=0}^N a_k e^{-i2\pi k \Delta v} \quad (4)$$

where Δv is the fractional part of v .

In a naive frequency domain method, we define the response of the FIR filter by setting the gain G_i and phase shift ζ_i for $M+1$ tunes: $v_i = 0, v_1, v_2, v_3, \dots, v_M$ as

$$G_i e^{i\zeta_i} = G(v_i) e^{i\zeta(v_i)} = \sum_{k=0}^N a_k e^{-i2\pi k v_i} \quad (5)$$

With setting $G_0 = 0$ to eliminate the offset that produced by the voltage $\Delta V_{ij}(t)$. The number of the conditions here is $2M+1$, therefore, as the solutions of Eq. (5), we have $2M+1$ coefficients for a_{k_i} for $i = 1, 2, 3, \dots, 2M+1$, by setting $a_{k_i} = 0$ otherwise. However, we usually need a position data at $k \sim N_p = 1/(\Delta v_i)$ for the oldest position to obtain a FIR filter with "good" response: smaller gain not at target tunes v_i . And if $2M+1 < N_p$, we have more data than $2M+1$ in the processor. To use those data, we impose the minimization of

$$P = \int_0^1 G(v)^2 dv = 2\pi \sum_{k=0}^N a_k^2 \quad (6)$$

to the coefficients and we obtain the coefficients up to the number of data points $N_p + 1$. This condition is the minimization of the noise power passing through the FIR filter and smaller gain not at target tunes is expected.

For some cases, we impose a condition for FIR filter as

$$\left. \frac{\partial G(v) e^{i\zeta(v)}}{\partial v} \right|_{v=v_i} = -i2\pi \sum_{k=0}^N a_k k e^{-i2\pi k v_i} = 0 \quad (7)$$

to flatten the tune response of the filter in the vicinity of v_i . This condition is equivalent to

$$G(v_i + \delta) e^{i\zeta(v_i + \delta)} = G(v_i - \delta) e^{i\zeta(v_i - \delta)} = G_i e^{i\zeta_i} \quad (8)$$

for small $\delta \ll 1$ and is included to Eq. (5).

We proposed and are using a TDLSF method [8,13] to obtain the coefficients of FIR filters more than $2M+1$ and we verified that the TDLSF method and the minimization of P is equivalent.

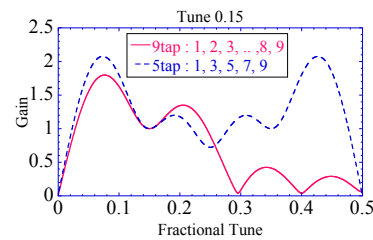

Figure 4: FIR filter for target tune 0.15 with $2M+1$ data (5tap) and $N_p=9$ data (9tap) with minimization of P . Gain in range 0.3 – 0.5 is smaller for 9tap as expected.

KICKERS

For transverse feedback, strip-line type kickers [14-16] in Fig. 5 are widely used to add transverse angle kick on the beam. A stripline kicker has the time constant $\tau_K =$

and DOI. $2 \times (\text{kicker length}) / (\text{speed of light})$ and usually τ_K is set to the bunch spacing for compromise of the smaller cross talk of the kick between bunches and larger kick efficiency, and for minimum beam signal from bunch trains. For SuperKEKB, the study for the improvement against beam heating of electrodes are under way [17].

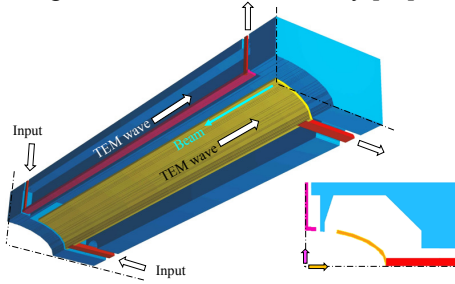

Figure 5: Example of transverse stripline kicker. 1/4 part and its cross-sectional view is shown.

For energy kicker of longitudinal feedback, DAΦNE type overdamped low Q cavities [18,19] are widely used. For the SPring-8 at 6GeV, a longitudinal feedback was required. Though the beam energy and the size of the ring are large, available space for kickers is limited. Therefore, we developed a high efficiency and short low Q cavity kicker [20,21] in Fig. 6. The shunt impedance of the SPring-8 kicker is more than 1 kΩ; comparable to the DAΦNE type [14,15,22] for 500MHz bunch rate, and its length is a half of that. And, by setting the kicker frequency to $(3+1/4) f_{RF}$, we can use three wave drive for each bunch with small loss (-3%) of the kick voltage compared with full wave drive with $(3+1/4)$ waves, therefore, we eliminated rather complicated QPSK modulator [23] required to drive the kicker with fractional number of waves.

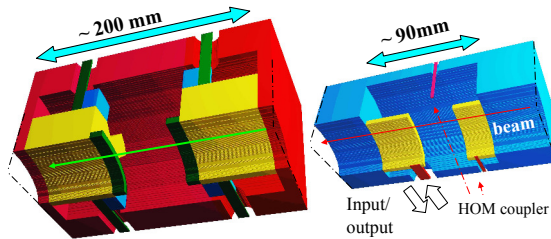

Figure 6: Longitudinal energy kickers: DAΦNE type (left) and SPring-8 type (right). 1/4 part is shown.

SINGLE-LOOP TWO-DIMENSIONAL FEEDBACK

Several storage rings employed the single-loop two-dimensional feedback [24-26] in Fig. 7. For such feedback, the pair of BPM electrodes and kicker electrode(s) should be placed at skewed positions to detect the horizontal and vertical position and to kick horizontally and vertically. Also, the tunes for horizontal and vertical should be well separated for an FIR filter to control the gain and phase individually for those tunes as shown in Fig. 8.

Another example of two tunes control is the longitudinal feedback at DAΦNE. The dipole oscillation of the tune ν_s and the quadrupole oscillation of tune $\sim 2\nu_s$ are simultaneously controlled by changing the response of an FIR

filter at ν_s and $2\nu_s$ and add dipole and quadrupole kick by kick timing shift [27].

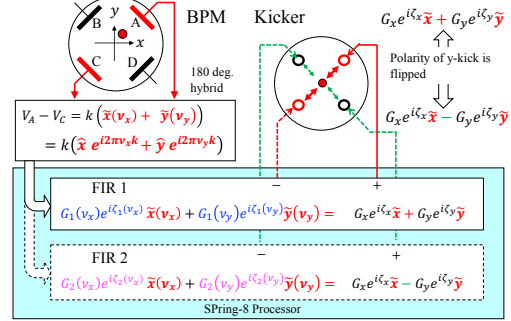

Figure 7: Single-loop two-dimensional feedback. In principle, just solid line signal is enough. To increase the kick with four stripline electrodes, another FIR filter (FIR 2) is required as the old and new SPring-8 processor.

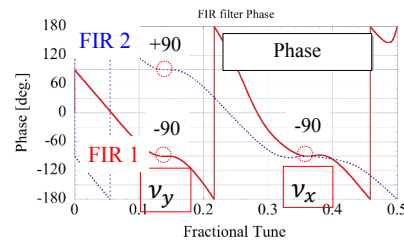

Figure 8: FIR filters for PLS-II case [26]. FIR 1 is with 12 turns data and FIR 2 is with 9 turns data. For ν_y , the sign of the kick is flipped between FIR 1 and FIR 2.

NOISE IN BPM SIGNAL

The random noise in a position signal kicks a beam and excites the oscillation. The analysis of the effect [28] shows the relation of the effective beam size driven by noise, σ_x , the feedback damping time τ_{FB} , the total damping time τ_{Total} including radiation damping, the revolution period T , and the resolution of the BPM σ_{BPM} , has the relation of $\sigma_x = (\sqrt{\tau_{FB} T / \tau_{total}}) \sigma_{BPM}$; this result is the same as the case of analog feedback in Ref [29].

For SPring-8 case, the vertical beam size is ten micrometers and to keep the beam size increase by noise much smaller than this beam size, a high resolution shorted stripline type BPM was newly installed for the feedback [16].

HYBRID FILLING

“Hybrid filling” is a filling mode with singlet bunch(es) of high bunch current, and bunch train(s) with low bunch current, and is operated at light sources by request of users. In this filling, a transverse feedback system need to suppress the single bunch instabilities of singlets and the multi-bunch instabilities of trains simultaneously.

However, the level of BPM signal V_{ij} is proportional to bunch current and a single RF amplifier in a front-end cannot handle simultaneously high level signals of singlet(s) and low level signals of train(s) without the saturations for singlet and with enough feedback damping and resolution of an ADC data for low bunch current.

Content from this work may be used under the terms of the CC BY 3.0 licence (© 2018).

For SPring-8 with various hybrid filling modes, the bunch current sensitive fast attenuator system [30,31] was first developed, and later a new feedback processor [32,33] (Fig. 9) was developed and is in operation. The new processor has multiple ADCs; each connected a front-end optimized to some range of bunch current and the processor measures the bunch current of each bunch and chooses data of an ADC that has a front-end matched to the bunch current to cover the all bunch current of hybrid filling modes.

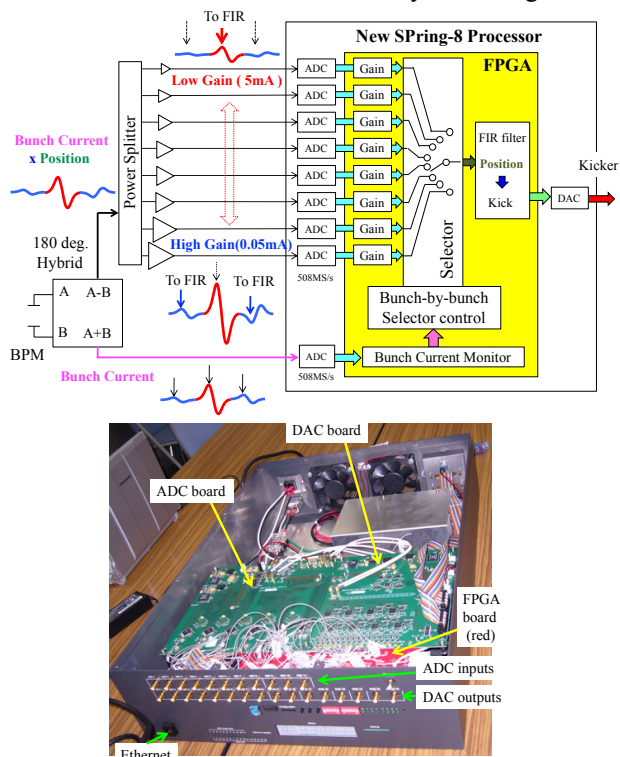

Figure 9: New SPring-8 processor for hybrid filling.

Hybrid filling at SPring-8, the gap between bunch trains and the filling time of acceleration cavities are comparable, therefore, the transient beam loading of cavities modulates the amplitude and phase of the cavity voltage and produces the timing spread of ~ 100 ps between bunches. To obtain wide timing acceptance of the feedback, we choose rather lower frequency range around 500MHz as a target frequency of front-end circuits.

INSTABILITY DRIVEN BY FEEDBACK

For usual feedback system that calculates the feedback kick from turn-by-turn beam position data, if we set its gain too high, the feedback excites beam oscillation [34]. The simulation results with a sample feedback system with tune 0.15 is shown in Fig. 10, in which a BPM and a kicker are placed at the same location and the betatron phase difference is zero, therefore, the required phase shift of the FIR filter for maximum damping is $\zeta_0 = -90$ degree. The gain G is indicated with “expected” feedback damping time τ_{FB} as $1/G = \tau_{FB}/T$ where T is the revolution period of the ring. In Fig. 10, a slow oscillation grows up for τ_{FB} less than $3.8T$. The FIR filter is the same as 9tap in Fig. 5 and its tune response of the phase and the spectrum of the

beam response are shown in Fig. 11. The tune of the excited oscillation is shifted from the original tune to the tune at the edge of the stable region where the phase shift by the FIR filter is between -180 to 0 degree ($\zeta_0 \pm 90$ deg.).

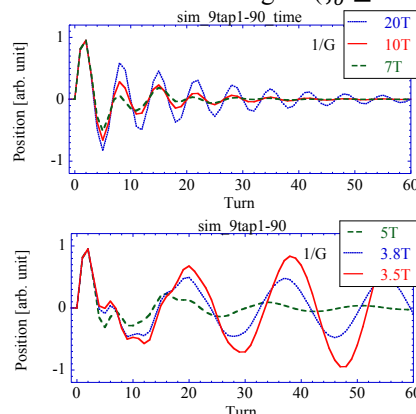

Figure 10: Beam response for kick at turn 0.

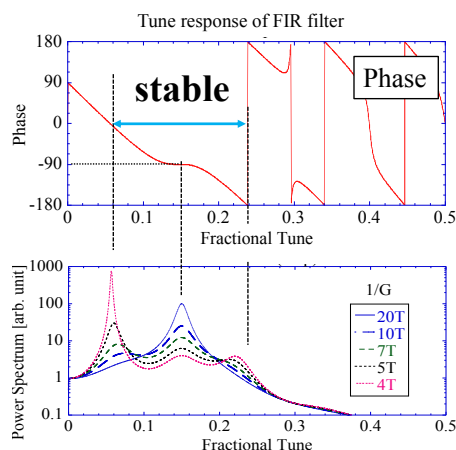

Figure 11: Phase response of FIR filter (top) and spectrum of beam response in Fig.

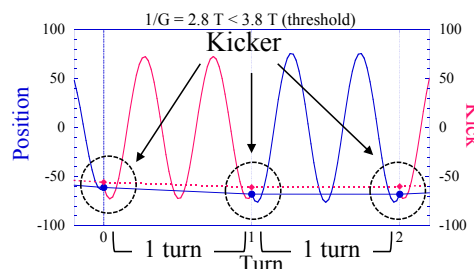

Figure 12: Beam motion in a ring and feedback kick for unstable beam with $\tau_{FB} = 2.8 T (< 3.8 T : \text{threshold})$.

The calculated motion of an unstable beam with high gain $\tau_{FB} = 2.8T$ is shown in Fig. 12. The feedback kick is defocusing, and shifts the tune lower to unstable region. Therefore, the source of the instability is the loop: the feedback calculates kick from the turn-by-turn position data that is affected by kicks at previous turns. In this case, the tune shift is negative, however, if the gain at the tune of higher edge of stable region is high enough, then the tune may shift to positive and the beam is unstable at higher tune. Or, in some cases, the half integer resonance might be excited by this tune shift.

FEEDBACK WITH MULTIPLE BPMS

To eliminate this loop, we consider a feedback that calculates the kick with the single turn position data at multiple locations in a ring [33-40] as shown in Fig. 13 and 14. For the cases with two BPMS, this scheme is a digital version of analog feedback.

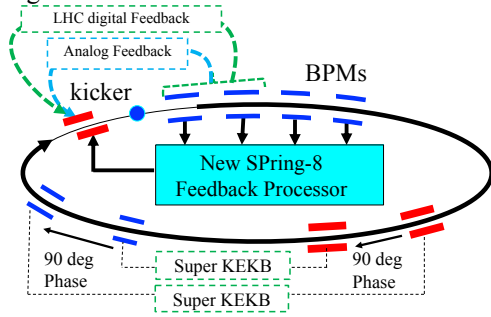

Figure 13: Feedback with multiple BPMS [33-40].

Here we show a scheme with cascaded two FIR filters [34,35], FIR-M and FIR-T (Fig. 14). FIR-M calculates the kick using the beam position data at multiple locations in a ring. In principle, we can eliminate the DC offset in its output with more than three BPMS, however, contrary to the turn-by-turn history case, the DC offset of each BPM changes independently by the shift of the closed orbit or of the amplifier gain and this independent shift break the cancellation condition of DC offset by FIR-M. Therefore, we use FIR-T to remove the DC offset in the output of FIR-M. FIR-T is a FIR filter with turn-by-turn history data of the output of FIR-M. We set a sample filter for FIR-M and FIR-T as shown in Fig. 15 and Fig. 16 and the simulation result with them is shown in Fig. 17. The beam is stable for $\tau_{FB} = 1.01T$ and is unstable less than $1T$. However, even ideal feedback of which kick angle θ is proportional to the instantaneous beam angle x' as $\theta = -2Gx' = -2(T/\tau_{FB})x'$ is unstable for $\tau_{FB} < 1T$ or $G > 1$.

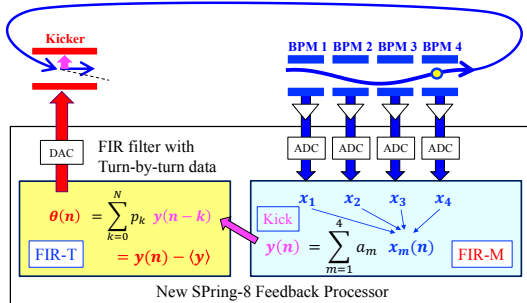

Figure 14: Cascaded FIR filters.

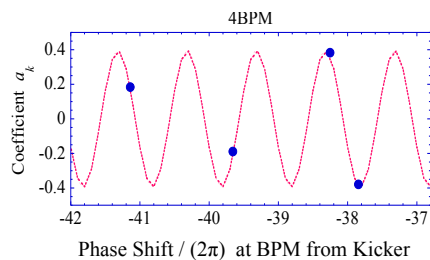

Figure 15: Phase of four BPMS and phase shift from the kicker.

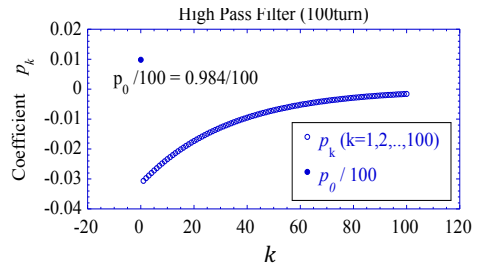

Figure 15: Coefficients of FIR-M (top) with BPM tunes from kicker and coefficients of FIR-T (bottom).

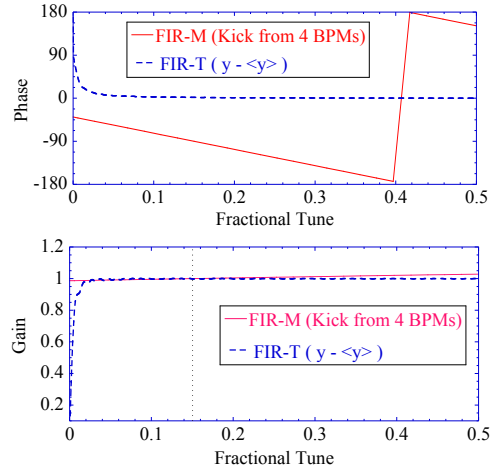

Figure 16: Tune response of FIR-M and FIR-T.

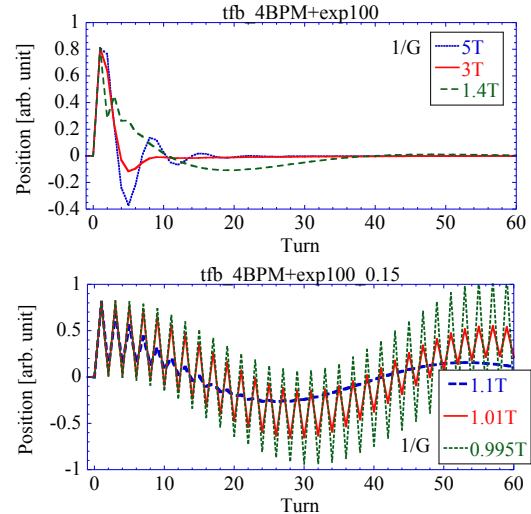

Figure 17: Beam response for feedback with multiple BPMS.

ACKNOWLEDGEMENT

The author would like to thank D. Teytelman (Dimtel), M. Tobiyama and T. Obina at KEK, A. Drago (INFN), R. Nagaoka and S. Rajesh at SOLEIL, E.-H Lee, D.-T. Kim, and S. Shin at PAL/PLS-II, for offering the information of their systems and collaboration, and to thank the colleagues in SPring-8, K. Kobayashi, T. Fujita, M. Masaki, H. Dewa, S. Sasaki, H. Ohkuma, N. Kumagai, M. Shoji, M. Ohisi, K. Tamura, Y. Taniuchi for their cooperation and support for feedback. I also thank Tokyo Electron Device, LTD for their help for development of feedback processors.

Content from this work may be used under the terms of the CC BY 3.0 licence (© 2018). Any distribution of this work must maintain attribution to the author(s), title of the work, publisher, and DOI.

REFERENCES

- [1] M. Lonza and H. Schmickler, “Multi-bunch Feedback Systems”, <https://arxiv.org/abs/1601.05258>
- [2] M. Lonza, “Multi-bunch Feedback Systems”, CERN Acc. School, “Beam Diagnostics”, FRANCE, 2008.
- [3] J. Fox, et al. “Feedback Control of Particle Beam Instabilities”, U.S. Particle Accelerator School, 2012.
- [4] T. Nakamura, K. Kobayashi, and Z. Zhou, in *Proc. EPAC’08*, paper THPC128, Genoa, Italy.
- [5] G. Oxoby, et al. “Bunch-by-Bunch Longitudinal Feedback System for PEP-II”, SLAC-PUB-6520/LBL-35780, June 1994.
- [6] D. Bulfone, V. Forchi, M. Lonza, L. Zambon, and M. Dehler, “The ELETTRA Digital Multi-bunch Feedback System”, in *Proc. EPAC’02*, paper THPRI035, Paris, France,
- [7] M. Tobiyama and E. Kikutani, “Development of a high-speed digital signal process system for bunch-by-bunch feedback systems”, *Phys. Rev. ST Accel. Beams* 3,012801(2000).
- [8] T. Nakamura, S. Date, K. Kobayashi, and T. Oshima, “Transverse Bunch-by-bunch Feedback for the SPring-8 Storage Ring”, in *Proc. EPAC’04*, paper THPLT068, Lucerne, Switzerland.
- [9] T. Nakamura and K. Kobayashi, in *Proc. ICALEPCS’05*, paper P3_022, Geneva, Switzerland.
- [10] D. Teytelman, et al., “Design and Testing of Gproto Bunch-by-bunch Signal Processor”, in *Proc. EPAC’06*, paper THPCH103, Edinburgh, Scotland.
- [11] E. Plouviez, et al., “Broadband Bunch by Bunch Feedback for the ESRF Using a Single High Resolution and Fast Sampling FPGA DSP”, in *Proc. EPAC’06*, paper THPCH082, Edinburgh, Scotland.
- [12] M. G. Abbott, G. Rehm, and I.S. Uzun, “A New Transverse and Longitudinal Bunch by bunch Feedback Processor”, in *Proc. ICALEPCS’17*, paper THPHA115, Barcelona, Spain.
- [13] C.-Y. Yao, E. Norum, and N. DiMonte, “An FPGA-Based Bunch-to-bunch Feedback System at the Advanced Photon Source”, in *Proc. PAC’07*, paper MO-PAN116, Albuquerque, USA.
- [14] M. Dehler, “Kicker Design for the ELETTRA/SLS Longitudinal Multi-bunch Feedback”, in *Proc. EPAC’02*, paper THPRI031, Paris, France.
- [15] S. Khan, T. Knuth, A. Gallo, F. Marcellini, B. Sparato and M. Zobov, “Longitudinal and Transverse Feedback Kickers for BESSI II Storage Ring”, in *Proc. PAC’99*, paper TUA33, New York, USA.
- [16] T. Nakamura, in *Proc. DIPAC’05*, POW027, France.
- [17] M. Tobiyama, KEK. private communication.
- [18] R. Boni, et al., in *Proc. EPAC96*, THP034L, Spain.
- [19] R. Boni, et al., “A Waveguide Overloaded Cavity as Longitudinal Kicker for the DAΦNE Bunch-by-bunch Feedback System”, *Particle Accelerators*, vol. 52, pp. 95-113 (1996).
- [20] T. Nakamura, “Resonant Strip-line Type Longitudinal Kicker”, in *Proc. IPAC’11*, mopo007, Spain.
- [21] M. Masaki, et al., in *Proc. IBIC’13*, TUPC18, UK.
- [22] W. K. Lau, et al., “A New Kicker for the TLS Longitudinal Feedback System”, in *Proc. PAC’05*, paper MPPPO05, Knoxville, USA.
- [23] A. Young, J. Fox, and D. Teytelman, in *Proc. PAC’97*, 6P057, Vancouver, Canada.
- [24] T. Nakamura, K. Kobayashi, W. X. Cheng, T. Honda, M. Izawa, T. Obina, and M. Tadano, “Single-Loop Two-Dimensional Transverse Feedback for Photon Factory”, in *Proc. EPAC’06*, paper THPCH092, Edinburgh, Scotland.
- [25] K. H. Hu, et al. “Commissioning of the Digital Transverse Bunch-by-bunch Feedback System for the TLS”, in *Proc. EPAC’06*, THPCH097, Scotland.
- [26] E.-H Lee, D.-T. Kim, H.-Y. Huang, S. Shin, T. Nakamura, and K. Kobayashi, “A transverse bunch by bunch feedback system for Pohang Light Source upgrade”, *Rev. Sci. Instrum.* 85, 125102 (2014);
- [27] A. Drago, A. Gallo, A. Ghigo, M. Zobov, J. D. Fox and D. Teytelman, “Longitudinal Quadrupole Instability and Control in the Frascati DAΦNE Electron Ring”, *Phys. Rev. ST Accel. Beams*, 6, 052801, 2003.
- [28] T. Nakamura, in *Proc. NANOBEAM’05*, KEK Proceedings 2005-20 (<https://www2.kek.jp/library/index-e.html>), pp. 401-403, Kyoto, Japan.
- [29] A. W. Chao, P. L. Morton and J. R. Rees, in *Proc. Pac’79*, IEEE Trans. Nuc. Sci., NS-26, No. 3, 1979.
- [30] T. Nakamura, et al. *Proc. EPAC08*, THPC127, Italy.
- [31] K. Kobayashi and T. Nakamura, in *Proc. ICALEPCS’09*, paper THB006, Japan.
- [32] K. Kobayashi, T. Nakamura, M. Masaki, and T. Fujita, “Development of a New Bunch-by-bunch Feedback Signal Processor at the SPring-8 Ring”, in *Proc. 12-th Ann. Meet. Part. Accel. Soc. Japan*, paper WEOL03, Aug. 5-7, 2015, Tsuruga, Japan.
- [33] T. Nakamura, et al., “Bunch-by-bunch Feedback System for Hybrid Filling and Recent Topics in SPring-8”, TWICE’14, 2014, SOLEIL, France.
- [34] T. Nakamura, “Stability Analysis of Transverse Feedback and Its Enhancement with Multiple BPMs”, *71th Ann. Meet. Phys. Soc. Japan*, 19aAQ-4, (https://doi.org/10.11316/jpsgaiyo.71.1.0_556), 2016.
- [35] T. Nakamura, “Stabilization of High Gain Transverse Feedback by Multiple BPMs”, *14th Ann. Meet. Part. Accel. Soc. Japan*, paper TUP090, Aug. 1-3, 2017.
- [36] M. Tobiyama, et al., in *Proc. IBIC’16*, paper MOAL03, Barcelona, Spain.
- [37] M. Tobiyama, et al., “Bunch by bunch Feedback System for SuperKEKB”, in *Proc. 13th Ann. Meet. Particle Accel. Soc. Japan*, TUOM06, 2016, Chiba.
- [38] P. Baudrengnien, et al., “LHC Transverse Feedback System and Its Hardware Commissioning”, in *Proc. EPAC’08*, paper HTPC121, Genoa, Italy.
- [39] A. Drago, “Feedback Systems for FCC-ee”, <https://arxiv.org/abs/1704.06162v2>
- [40] A. Drago, “FCC-ee Feedback System Design Update”, 4th Ann. Meet. Future Circular Collider Study, April 9-13, 2018, Amsterdam, the Netherlands.