

OPTIONS FOR THE SPECTROMETER MAGNET OF THE ERHIC IR*

H. Witte[†], B. Parker, R. Palmer, Brookhaven National Laboratory, Upton, NY, USA

Abstract

Presently the electron-ion collider eRHIC is under design, which aims to provide a facility with a peak luminosity of $10^{34} \text{cm}^{-2} \text{sec}^{-1}$. This paper outlines different concepts for the so-called B0 magnet, which is the first bending magnet after the interaction region.

The B0 magnet has to provide a 1.3T dipole field to the hadron beam, while the nearby electron beam should not be exposed to any field. Several possible solutions have been evaluated, each with their specific strengths and shortcomings. This paper presents an overview of the solutions.

INTRODUCTION

The B0 magnet is a 1.2 m long magnet located 5.6 m from the IP. Due to the close proximity to the IP the beams are not very separated, so the B0 magnet aperture needs to accommodate both the electron and hadron beam. The main purpose of the B0 magnet is to provide a dipole field to the hadron beam, while the electron beam needs to be shielded from this field.

At the entrance of the magnet the two beams are about 100 mm apart. In vertical direction the aperture needs to be at least 240 mm to allow sufficient space for particle detectors.

Several concepts have been considered for the B0 magnet, three of which are presented in this paper.

SEPTUM DESIGN

One option is a superconducting septum design, where the two beams are separated by a current sheet as shown in Fig. 1. An iron yoke, in the shape of a c-core magnet, provides the desired dipole field to the hadron beam. In this design the electron beam passes through the back-yoke of the c-core magnet; if the yoke is not saturated the field leakage is relatively small.

Additional shielding needs to be provided to suppress the stray field to a minimum, which is shown in Fig. 2. It was found that a 1 mm thick layer of AISI 1006 steel and a 1 mm layer of mu-metal is sufficient to suppress the residual stray field. The passive shielding needs to be extended beyond the yoke to provide adequate shielding from stray fields outside of the yoke.

Figure 3 shows the results of a 3D simulation of the vertical magnetic field experienced by the hadron and electron beams.

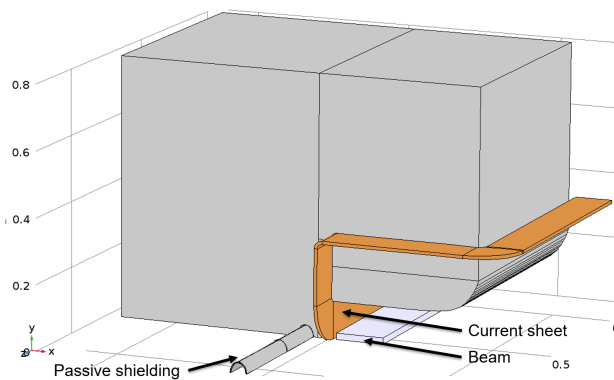

Figure 1: Septum design.

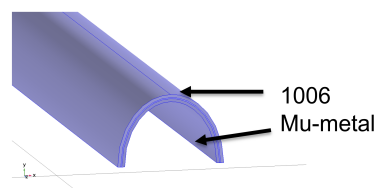

Figure 2: Septum design, shielded region.

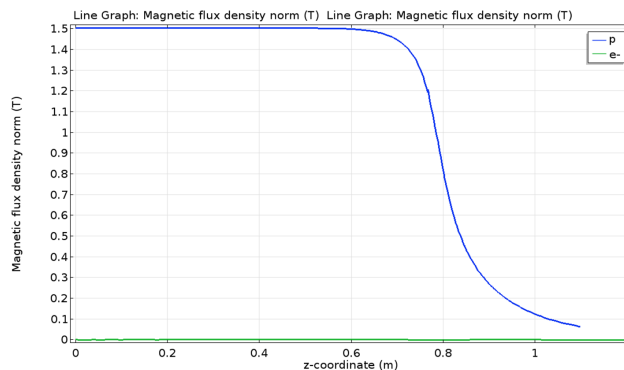

Figure 3: Septum design, field comparison.

HALBACH OPTION

To allow for more space for the detectors actively shielded solutions are considered as well. One option is to use permanent magnetic material to cancel out the hadron dipole field using the well-known Halbach arrangement [1].

The hadron dipole field in this case can be provided by a simple window-frame magnet. The excitation coil of the window frame magnet can be a racetrack coil or wrapped around the back-yoke as shown in Fig. 4; the coil can be normal conducting or superconducting (super-ferric).

To suppress the hadron dipole field the Halbach compensation magnet has to provide a dipole field with the same field profile along the length of the magnet. This can be accomplished by varying the outer radius of the Halbach

* Work supported by Brookhaven Science Associates, LLC under Contract No. DE-AC02-98CH10886 with the U.S. Department of Energy.

[†] hwitte@bnl.gov

Content from this work may be used under the terms of the CC BY 3.0 licence (© 2018). Any distribution of this work must maintain attribution to the author(s), title of the work, publisher, and DOI.

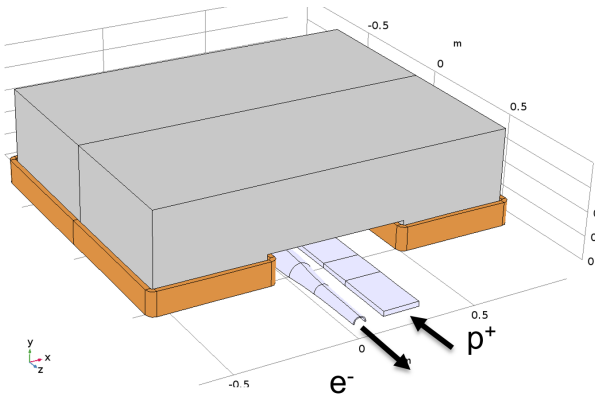

Figure 4: Halbach Option.

magnet as a function of the longitudinal position:

$$r_o(z) = r_i(z) \cdot e^{(B_y(z)/B_r)} \quad (1)$$

In this equation B_r is the remanent magnetic field of the permanent magnetic material (for NdFeB typically between 1.1 and 1.47 T).

Interesting in this respect is that the inner radius of the Halbach magnet can be adjusted as well to keep the outer radius of the magnet as small as possible to increase the space for detectors. Figure 5 shows the shape of such a Halbach magnet and Fig. 6 the inner and outer radius of the magnet as a function of the longitudinal position.

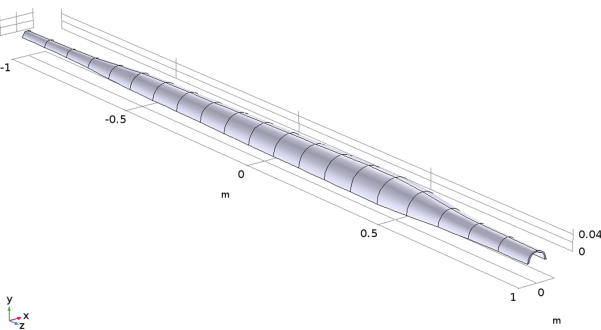

Figure 5: Geometry Halbach magnet.

The calculated shape can match the original field of the B0 magnet very well, as shown in Fig. 7. Note that in the figure the Halbach geometry extends ± 1 m.

One potential issue with this approach is the demagnetization of the permanent magnetic material. For a space efficient design the remanent field needs to be as high as possible; these materials however usually have a relatively low coercivity. Interesting is also the use of permanent magnetic material at 77K, which provides a better performance than standard materials at room temperature [2].

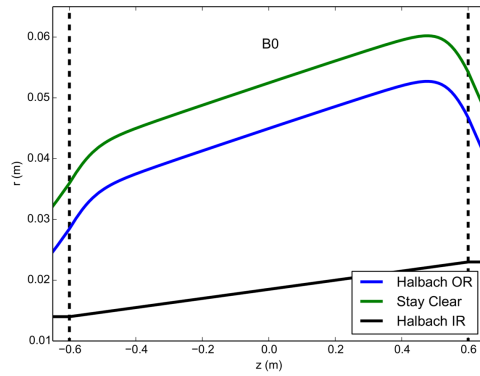

Figure 6: Inner and outer radius of the considered Halbach magnet.

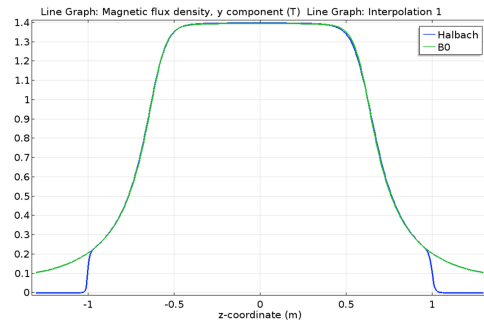

Figure 7: Comparison of the B0 field and cancellation field generated by the Halbach dipole.

SUPERCONDUCTING COMPENSATION DIPOLE

The compensation field can also be provided by a superconducting NbTi dipole magnet. Similar to the Halbach magnet option the field profile has to be matched to that of the B0 magnet. Several options to accomplish this are possible; here we outline a solution employing the double-helix or helical coil concept.

Helical coils have been discussed since the 1970s [3]; the concept has been shown to be capable of generating arbitrary multipole magnets [4] and combinations thereof [5]. The conductor path can be described by the following equations:

$$x(\theta) = R \cdot \cos \theta \quad (2)$$

$$y(\theta) = R \cdot \sin \theta \quad (3)$$

$$z(\theta) = \frac{h\theta}{2\pi} + \frac{R}{\tan(\alpha)} \sum_n \varepsilon_n \sin(n\theta) \quad (4)$$

Here θ is the azimuthal angle, R the coil radius, h the winding pitch, α the tilt angle of a single turn with respect to the central axis and n the multipole order. ε_n is an additional parameter for combined function magnets, which allows to adjust the individual multipole components.

To match the field profile of the compensation coil to that of the B0 magnet the tilt angle α can be varied along the length of the magnet. Figure 8 shows an example of this for the here discussed B0 magnet. Figure 9 (a) and (b) show

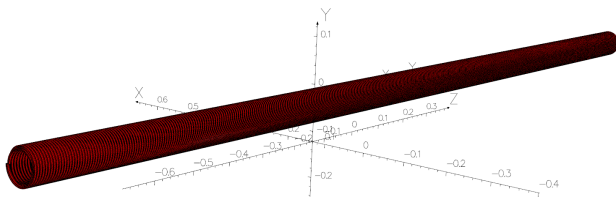

Figure 8: 2m long superconducting compensation dipole.

the windings at the beginning (or end) and middle of the magnet; as shown in the figure, the tilt angle is close to 90° at the coil ends, which means only solenoidal components are generated (which are intrinsically cancelled by a 2nd helical coil layer).

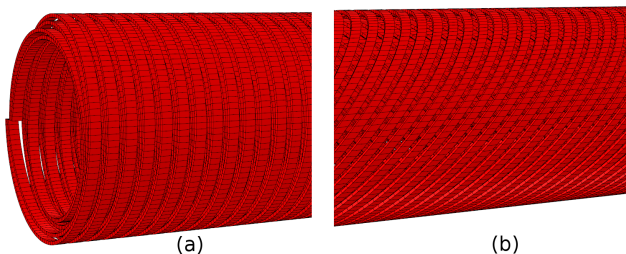

Figure 9: Windings at the beginning (a) and in the middle (b) of the compensation dipole.

The superconducting compensation dipole has an external stray magnetic field, which perturbs the original dipole field of the B0 magnet. In an iterative process the shielding performance of the compensation dipole can be improved, as shown in Fig. 10.

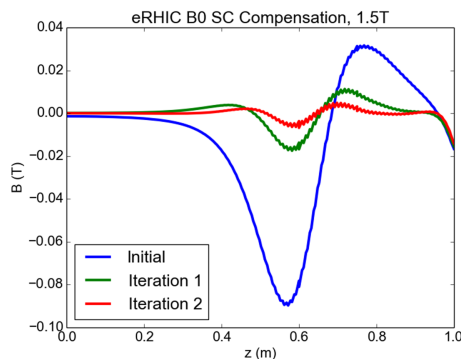

Figure 10: Shielding performance. The figure shows the residual dipole field after several iterations.

CONCLUSION

Several options for the B0 spectrometer magnet were explored, each with specific advantages and disadvantages. The superconducting septum option is probably the most conservative one. The shielding is completely passive and

works for any magnetic field of the B0 magnet. The field quality for the hadron beam is unaffected by the shielding and can be designed to be very good. The disadvantage of this design is the size of the magnet (~ 20 tons iron return yoke) and the limited space for detectors (no space beyond the septum).

The Halbach option is attractive in that compensation is provided by a passive device; more space is available for detectors and the dipole field for the hadrons can be provided by a simple window-frame magnet. The fringe field of the Halbach magnet decays rapidly outside the aperture, and therefore does not perturb the dipole field seen by the hadron beam. The magnetic permeability of common permanent magnet material (NdFeB) is close to one, which means field lines are not distorted. However, the Halbach magnet design is limited by the demagnetization effect. The coercivity under all conditions must be high enough so that the magnet does not undergo (partial) demagnetization. Material with a high magnetic remanence, which is required for a space efficient design, typically has a low coercivity. For best performance special alloys suitable for low temperature can be employed, which requires a simple cryostat for 77 K operation. The biggest impediment is the fixed compensation field; if different settings are required the compensation dipole would have to be replaced.

The compensation field can also be provided by a superconducting magnet; matching the field profile of the B0 magnet leads to a fairly complex windings. Similar to the Halbach magnet design more space for the detectors is available, and in principle this solution can be made to work for multiple field configurations. The stray magnetic field of the compensation dipole affects the field quality of the B0 magnet, which needs to be investigated if acceptable.

The Halbach option as well as the superconducting magnet option may require additional passive shielding on the inside of the compensation magnet to cancel any residual field.

REFERENCES

- [1] K. Halbach. "Design of permanent multipole magnets with oriented rare earth cobalt material," *Nucl. Instr. Meth.*, vol. 169, no. 1, pp. 1–10, 1980.
- [2] K. Uestuener *et al.*, "Sintered (Pr,Nd)-Fe-B permanent magnets with (BH) max of 520 kJ/m³ at 85 K for cryogenic applications," In *20th REPM*, Heraklion, 2008.
- [3] D. Meyer and R. Flasck. "A new configuration for a dipole magnet for use in high energy physics applications." *Nucl. Instr. Meth.*, vol. 80, no. 2, pp. 339–341, 1970.
- [4] R. Meinke, C. Goodzeit, and M. Ball, "Modulated double-helix quadrupole magnets," *IEEE Trans. Appl. Supercond.*, vol. 13, no. 2, pp. 1369–1372, 2003.
- [5] H. Witte *et al.*, "The Advantages and Challenges of Helical Coils for Small Accelerators—A Case Study." *IEEE Trans. Appl. Supercond.*, vol. 22, no. 2, pp. 4100110–4100110, 2012.